



SHINE KITCHEN 60

SHINE
KITCHEN

**La elegancia completamente
en acero inoxidable.**

Great performances in small spaces



Conjunto Shine Kitchen
+ Línea 60



ARMARIO PARED
PP/645DX



ARMARIO PARED
PPV/630SX



**ARMARIO PARED
ANGULAR**
PPA/680



**ARMARIO
ESCURREPLATOS**
PPS/690



**CONJUNTO FREGADERO
CON MUEBLE**
L/6122DX+BPL/690+BC4/630



**FREGADERO CON
MUEBLE ANGULAR**
BPAL/680+LA/680



Tabella					
MOD. SP	INT 1	INT 2	-	MOD. PP	INT 3
SP/630	276		-	PP-630 SX/DX	190
SP/640	376		-	PP-640 SX/DX	290
SP/645	426		-	PP-645 SX/DX	340
SP/650	476		-	PP-650 SX/DX	390
SP/670	676		-	PP-660/PPS-660	490
SP/6105	1026		-	PP-670	590
SP/6110	1076		-	PP-680	690
SP/6125	1226		-	PP-690/PPS-690	790
SP/6135	1326		-	PP-6100	890
SP-SK/660		576	-	PP-6105	940
SP-SK/680		776	-	PP-6110	990
SP-SK/690		876	-	PP-6120	1090
SP-SK/6100		976	-	PP-6125	1140
SP-SK/6120		1176	-	PP-6135	1240
SP-SK/6140		1376	-	PP-6150	1390
SP-SK/6150		1476	-		
SP-SK/6160		1576	-		
SP-SK/6180		1776	-		
SP-SK/6200		1976	-		

CASSETTIERE

MOD. COD.	DESCRIZIONE/DESCRIPTION/BEZEICHNUNG/DESCRIPTION/DESCRIPCIÓN DIMENSIONI/DIMENSIONS/ABMESSUNGEN/DIMENSIONS/DIMENSIONES	POTENZA/POWER/LEISTUNG/PUISSANCE/POTENCIA VOLTAGGIO/VOLTAGE/SPANNUNG/VOLTAGE/VOLTAGE	$\frac{kW}{kcal/h}$ $\frac{kW}{V \cdot Hz}$	PREZZO/PRICE € PREIS/PRIX/PRECIO € KG / M ³
BC1/660 01070601	1 CASSETTO cm.51,8x52x57,2 EN 1 DRAWER cm.51,8x52x57,2 • DE 1 SCHUBLADEN cm.51,8x52x57,2 • FR 1 TIROIR cm.51,8x52x57,2 • ES 1 CAJONE CM.51,8X52X57,2 cm. 60x 56,6x 81h			1.138,00 41 / 0,40
BC2/640 01070402	2 CASSETTI cm.31,8x52x25 EN 2 DRAWERS cm.31,8x52x25 • DE 2 SCHUBLADEN cm.31,8x52x25 • FR 2 TIROIRS cm.31,8x52x25 • ES 2 CAJONES CM.31,8X52X25 cm. 40x 56,6x 81h			1.064,00 35 / 0,28
BC2/645 01070452	2 CASSETTI cm.36,8x52x25 EN 2 DRAWERS cm.36,8x52x25 • DE 2 SCHUBLADEN cm.36,8x52x25 • FR 2 TIROIRS cm.36,8x52x25 • ES 2 CAJONES CM.36,8X52X25 cm. 45x 56,6x 81h			1.175,00 37.5 / 0,31
BC2/650 01070502	2 CASSETTI cm.41,8x52x25 EN 2 DRAWERS cm.41,8x52x25 • DE 2 SCHUBLADEN cm.41,8x52x25 • FR 2 TIROIRS cm.41,8x52x25 • ES 2 CAJONES CM.41,8X52X25 cm. 50x 56,6x 81h			1.266,00 40 / 0,34
BC2/660 01070602	2 CASSETTI cm.51,8x52x25 EN 2 DRAWERS cm.51,8x52x25 • DE 2 SCHUBLADEN cm.51,8x52x25 • FR 2 TIROIRS cm.51,8x52x25 • ES 2 CAJONES CM.51,8X52X25 cm. 60x 56,6x 81h			1.348,00 44 / 0,40
BC3/640 01070403	3 CASSETTI cm.31,8x52x14,3 EN 3 DRAWERS cm.31,8x52x14,3 • DE 3 SCHUBLADEN cm.31,8x52x14,3 • FR 3 TIROIRS cm.31,8x52x14,3 • ES 3 CAJONES CM.31,8X52X14,3 cm. 40x 56,6x 81h			1.103,00 39 / 0,28
BC3/645 01070453	3 CASSETTI cm.36,8x52x14,3 EN 3 DRAWERS cm.36,8x52x14,3 • DE 3 SCHUBLADEN cm.36,8x52x14,3 • FR 3 TIROIRS cm.36,8x52x14,3 • ES 3 CAJONES CM.36,8X52X14,3 cm. 45x 56,6x 81h			1.331,00 41.5 / 0,31
BC3/650 01070503	3 CASSETTI cm.41,8x52x14,3 EN 3 DRAWERS cm.41,8x52x14,3 • DE 3 SCHUBLADEN cm.41,8x52x14,3 • FR 3 TIROIRS cm.41,8x52x14,3 • ES 3 CAJONES CM.41,8X52X14,3 cm. 50x 56,6x 81h			1.428,00 43 / 0,34
BC4/630 01070304	4 CASSETTI cm.21,8x52x8,9 EN 4 DRAWERS cm.21,8x52x8,9 • DE 4 SCHUBLADEN cm.21,8x52x8,9 • FR 4 TIROIRS cm.21,8x52x8,9 • ES 4 CAJONES CM.21,8X52X8,9 cm. 30x 56,6x 81h			1.175,00 37 / 0,22

CASSETTIERE

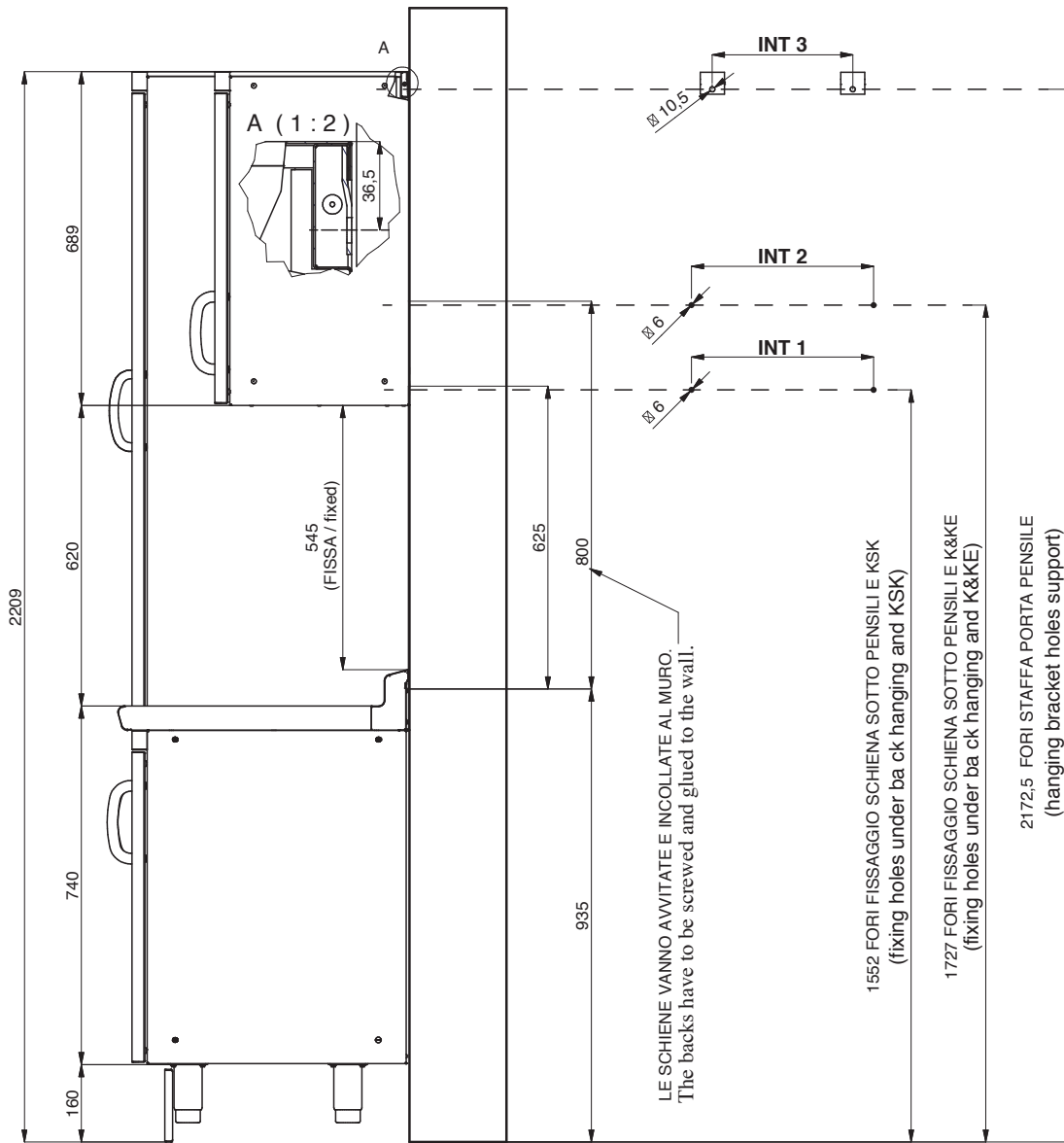
MOD. COD.	DESCRIZIONE/DESCRIPTION/BEZEICHNUNG/DESCRIPTION/DESCRIPCIÓN DIMENSIONI/DIMENSIONS/ABMESSUNGEN/DIMENSIONS/DIMENSIONES	POTENZA/POWER/LEISTUNG/PUISSANCE/POTENCIA VOLTAGGIO/VOLTAGE/SPANNUNG/VOLTAGE/VOLTAGE	$\frac{kW}{kcal/h}$ $\frac{V}{Hz}$	PREZZO/PRICE PREIS/PRIX/PRECIO € KG / M ³
BC4/640 01070404	4 CASSETTI cm.31,8x52x8,9 EN 4 DRAWERS cm.31,8x52x8,9 • DE 4 SCHUBLADEN cm.31,8x52x8,9 • FR 4 TIROIRS cm.31,8x52x8,9 • ES 4 CAJONES CM.31,8X52X8,9 cm. 40x 56,6x 81h			1.249,00 42 / 0,28
BC4/645 01070454	4 CASSETTI cm.36,8x52x8,9 EN 4 DRAWERS cm.36,8x52x8,9 • DE 4 SCHUBLADEN cm.36,8x52x8,9 • FR 4 TIROIRS cm.36,8x52x8,9 • ES 4 CAJONES CM.36,8X52X8,9 cm. 45x 56,6x 81h			1.487,00 43.5 / 0,31
BC2B/640 01080402	2 BACINELLE INOX GN 1/1 h20 EN 2 CONTAINERS INOX GN 1/1 h20 • DE 2 BEHALTERN INOX GN 1/1 h20 • FR 2 BACS INOX GN 1/1 h20 • ES 2 CONTENEDORES INOX GN 1/1 H20 cm. 40x 56,6x 81h			1.196,00 34 / 0,28
BP/630SX 01010301	BASE CON PORTA E RIPIANO INTERMEDIO EN STORAGE UNIT WITH DOOR AND MIDDLE SHELF • DE FLUGELTURELEMENT MIT ZWISCHENBORD • FR ELEMENT DE BASE AVEC PORTE ET ETAGERE INTERMEDIAIRE • ES BASE CON PUERTA Y ESTANTE INTERMEDIO cm. 30x 56,6x 81h			608,00 18 / 0,22
BP/640SX 01010401	cm. 40x 56,6x 81h			624,00 21 / 0,28
BP/645SX 01010451	cm. 45x 56,6x 81h			654,00 22.5 / 0,31
BP/650SX 01010501	cm. 50x 56,6x 81h			662,00 24 / 0,34
BP/630DX 01010300	cm. 30x 56,6x 81h			608,00 18 / 0,22
BP/640DX 01010400	cm. 40x 56,6x 81h			624,00 21 / 0,28
BP/645DX 01010450	cm. 45x 56,6x 81h			654,00 22.5 / 0,31
BP/650DX 01010500	cm. 50x 56,6x 81h			662,00 24 / 0,34
BP/660 01010600	BASE CON PORTE, GUARNIZIONE E RIPIANO INTERMEDIO EN STORAGE UNIT WITH DOORS , GASKET AND MIDDLE SHELF • DE FLUGELTURELEMENT MIT TURDICHTUNG UND ZWISCHENBORD • FR ELEMENT DE BASE AVEC PORTES , JOINT ET ETAGERE INTERMEDIAIRE • ES BASE CON PUERTAS, GUARNICION Y ESTANTE INTERMEDIO cm. 60x 56,6x 81h			872,00 28 / 0,40
BP/670 01010700	cm. 70x 56,6x 81h			906,00 32 / 0,46

MOBILI BASE

MOD. COD.	DESCRIZIONE/DESCRIPTION/BEZEICHNUNG/DESCRIPTION/DESCRIPCIÓN DIMENSIONI/DIMENSIONS/ABMESSUNGEN/DIMENSIONS/DIMENSIONES	POTENZA/POWER/LEISTUNG/PUISSANCE/POTENCIA VOLTAGGIO/VOLTAGE/SPANNUNG/VOLTAGE/VOLTAJE	kw kcal/h	kw V~ Hz	PREZZO/PRICE € PREIS/PRIX/PRECIO € KG / M ³
BP/680 01010800	cm. 80x 56,6x 81h				946,00 36 / 0,51
BP/690 01010900	cm. 90x 56,6x 81h				1.006,00 39 / 0,57
BP/6100 01011000	cm. 100x 56,6x 81h				1.057,00 42 / 0,63
BP/6105 01011050	BASE CON 3 PORTE, GUARNIZIONI E RIPIANO INTERMEDIO EN STORAGE UNIT WITH 3 DOORS , GASKETS AND MIDDLE SHELF • DE FLUGELTURELEMENT MIT 3 TUREN, TURDICHTUNGEN UND ZWISCHENBORD • FR ELEMENT DE BASE AVEC 3 PORTES , JOINTS ET ETAGERE INTERMEDIAIRE • ES BASE CON 3 PUERTAS, GUARNICION Y ESTANTE INTERMEDIO cm. 105x 56,6x 81h				1.259,00 43.5 / 0,66
BP/6110 01011100	cm. 110x 56,6x 81h				1.284,00 45 / 0,69
BP/6120 01011200	cm. 120x 56,6x 81h				1.331,00 48 / 0,75
BP/6125 01011250	cm. 125x 56,6x 81h				1.355,00 49.5 / 0,78
BP/6135 01011350	cm. 135x 56,6x 81h				1.405,00 52.5 / 0,83
BP/6150 01011500	cm. 150x 56,6x 81h				1.480,00 57 / 0,92
BPA/680 01110801	BASE AD ANGOLO CON PORTA E RIPIANO INTERMEDIO EN CORNER STORAGE UNIT WITH DOOR AND MIDDLE SHELF • DE ECK-ELEMENT 90° MIT TUR UND ZWISCHENBORD • FR ELEMENT DE BASE D'ANGLE AVEC PORTE ET ETAGERE INTERMEDIAIRE • ES BASE ANGULAR CON PUERTA Y ENTANTE INTERMEDIO cm.80/80x 56,6x 81h				1.202,00 41 / 0,70
PL/630 01310300	PIANO LAVORO CON ALZATINA E BORDO FRONTALE ARROTONDATO EN WORKTOP WITH RAISED AND REAR BORDER PROFILE ABGERUNDET. • DE OBERPLATTE MIT AUFKANTUNG HINTEN UND PROFILE ABGERUNDET. • FR PLAN DE TRAVAIL AVEC JOINT DE FINITION POSTERIEUR ET BORDE FRONTAL TOMBE' • ES SOBRE DE TRABAJO CON PETO TRASERO Y BORDE FRONTAL REDONDEADO cm. 30x 60x 5h				171,00 5,5 / 0,05
PL/640 01310400	cm. 40x 60x 5h				196,00 7,5 / 0,06
PL/645 01310450	cm. 45x 60x 5h				220,00 8,5 / 0,07
PL/650 01310500	cm. 50x 60x 5h				232,00 9 / 0,07

PIANI LAVORO

MOD. COD.	DESCRIZIONE/DESCRIPTION/BEZEICHNUNG/DESCRIPTION/DESCRIPCIÓN DIMENSIONI/DIMENSIONS/ABMESSUNGEN/DIMENSIONS/DIMENSIONES	POTENZA/POWER/LEISTUNG/PUISSANCE/POTENCIA VOLTAGGIO/VOLTAGE/SPANNUNG/VOLTAGE/VOLTAGE kcal/h	$\frac{\text{kW}}{\text{V}}$ $\frac{\text{Hz}}$	PREZZO/PRICE € PREIS/PRIX/PRECIO € KG / M ³
PL/660 01310600	cm. 60x 60x 5h			243,00 11 / 0,09
PL/670 01310700	cm. 70x 60x 5h			269,00 13 / 0,10
PL/675 01310750	cm. 75x 60x 5h			280,00 13.5 / 0,11
PL/680 01310800	cm. 80x 60x 5h			305,00 14,5 / 0,11
PL/690 01310900	cm. 90x 60x 5h			316,00 16,5 / 0,13
PL/6100 01311000	cm. 100x 60x 5h			330,00 18,5 / 0,14
PL/6105 01311050	cm. 105x 60x 5h			342,00 19,5 / 0,15
PL/6110 01311100	cm. 110x 60x 5h			354,00 20 / 0,15
PL/6120 01311200	cm. 120x 60x 5h			366,00 22 / 0,17
PL/6125 01311250	cm. 125x 60x 5h			378,00 23 / 0,17
PL/6130 01311300	cm. 130x 60x 5h			390,00 24 / 0,18
PL/6135 01311350	cm. 135x 60x 5h			402,00 24,5 / 0,19
PL/6140 01311400	cm. 140x 60x 5h			438,00 25,5 / 0,19
PL/6150 01311500	cm. 150x 60x 5h			463,00 27,5 / 0,21
PL/6160 01311600	cm. 160x 60x 5h			487,00 29,5 / 0,22
PL/6165 01311650	cm. 165x 60x 5h			512,00 30,5 / 0,23
PL/6180 01311800	cm. 180x 60x 5h			548,00 33 / 0,24
PL/6195 01311950	cm. 195x 60x 5h			597,00 35,5 / 0,26
PL/6200 01312000	cm. 200x 60x 5h			621,00 36,5 / 0,27

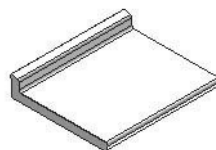

PIANI LAVORO

MOD. COD.	DESCRIZIONE/DESCRIPTION/BEZEICHNUNG/DESCRIPTION/DESCRIPCIÓN DIMENSIONI/DIMENSIONS/ABMESSUNGEN/DIMENSIONS/DIMENSIONES	POTENZA/POWER/LEISTUNG/PUISSANCE/POTENCIA VOLTAGGIO/VOLTAGE/SPANNUNG/VOLTAGE/VOLTAJE	kw kcal/h	kw V~ Hz	PREZZO/PRICE € PREIS/PRIX/PRECIO € KG / M³
PL/6210 01312100	cm. 210x 60x 5h				645,00 38,5 / 0,28
PL/6220 01312200	cm. 220x 60x 5h				671,00 40,5 / 0,30
PL/6225 01312250	cm. 225x 60x 5h				706,00 41,5 / 0,30
PL/6240 01312400	cm. 240x 60x 5h				755,00 44 / 0,32
PLA/680 01320800	PIANO LAVORO AD ANGOLO CON ALZATINA E BORDO FRONTALE ARROTONDATO EN CORNER WORKTOP WITH RAISED AND REAR BORDER • DE OBERPLATTE ECK-ELEMENT 90° MIT 75mm AUFKANTUNG HINTEN UND PROFILE ABGERUNDET. • FR PLAN DE TRAVAIL D'ANGLE AVEC JOINT DE FINITION POSTERIEUR ET BORD FRONTAL TOMBE' • ES SOBRE DE TRABAJO ANGULAR CON PETO TRASERO Y BORDE FRONTAL REDONDEADO cm.80/80x 60x 5h				484,00 18 / 0,16
BPL/645SX 01030451	BASE PER LAVELLO CON PORTA EN STORAGE UNIT FOR SINK WITH DOOR • DE FLUGELTURELEMENT FUR SPULBECKEN • FR ELEMENT DE BASE POUR EVIER AVEC PORTE • ES BASE PARA FREGADERO CON PUERTA cm. 45x 56,6x 81h				618,00 20.5 / 0,31
BPL/645DX 01030450	cm. 45x 56,6x 81h				618,00 20.5 / 0,31
BPL/660 01030600	BASE PER LAVELLO CON PORTE EN STORAGE UNIT FOR SINK WITH 2 DOORS • DE FLUGELTURELEMENT FUR SPULBECKEN • FR ELEMENT DE BASE POUR EVIER AVEC 2 PORTES • ES BASE PARA FREGADERO CON PUERTAS cm. 60x 56,6x 81h				833,00 26 / 0,40
BPL/690 01030900	cm. 90x 56,6x 81h				946,00 37 / 0,57

MOBILI BASE LAVELLO

MOD. COD.	DESCRIZIONE/DESCRIPTION/BEZEICHNUNG/DESCRIPTION/DESCRIPCIÓN DIMENSIONI/DIMENSIONS/ABMESSUNGEN/DIMENSIONS/DIMENSIONES	POTENZA/POWER/LEISTUNG/PUISSANCE/POTENCIA VOLTAGGIO/VOLTAGE/SPANNUNG/VOLTAGE/VOLTAGE	kw kcal/h	kw V- Hz	PREZZO/PRICE € PREIS/PRIX/PRECIO € KG / M ³
BPL/6105 01031050	BASE PER LAVELLO CON 3 PORTE EN STORAGE UNIT FOR SINK WITH 3 DOORS • DE FLUGELTURELEMENT FUR SPULBECKEN • FR ELEMENT DE BASE POUR EVIER AVEC 3 PORTES • ES BASE PARA FREGADERO CON 3 PUERTAS cm. 105x 56,6x 81h				979,00 41.5 / 0,66
BPL/6120 01031200	cm. 120x 56,6x 81h				1.236,00 45 / 0,75
BPL/6135 01031350	cm. 135x 56,6x 81h				1.291,00 49.5 / 0,83
BPL/6150 01031500	cm. 150x 56,6x 81h				1.344,00 54 / 0,92
BPAL/680 01130800	BASE PER LAVELLO AD ANGOLO CON PORTA EN CORNER STORAGE UNIT FOR SINK WITH DOOR • DE ECK-ELEMENT 90° FUR ECKSPULABDECKUNG MIT FLUGELTURE • FR ELEMENT DE BASE D'ANGLE POUR EVIER AVEC PORTE • ES BASE ANGULAR PARA FREGADERO CON PUERTA cm.80/80x 56,6x 81h				1.219,00 37 / 0,70
L/645 01330450	1 VASCA cm.29x35x14h EN 1 BOWL cm.29x35x14h • DE 1 BECKEN cm.29x35x14h • FR 1 BAC cm.29x35x14h • ES 1 CUBA CM.29X35X14H cm. 45x 60x 5h				366,00 9.5 / 0,12
L/660 01330600	1 VASCA cm.34x39x19,5h EN 1 BOWL cm.34x39x19,5h • DE 1 BECKEN cm.34x39x19,5h • FR 1 BAC cm.34x39x19,5h • ES 1 CUBA CM.34X39X19,5H cm. 60x 60x 5h				448,00 12 / 0,15
L/691 SX 01330902	1 VASCA SX cm.34x39x19,5h CON SGOCCIOLATOIO EN 1 BOWL LEFT cm.34x39x19,5h WITH DRAINING BOARD • DE 1 BECKEN LINKS cm.34x39x19,5h MIT ABTROPFFLACHE • FR 1 BAC A GAUCHE cm.34x39x19,5h AVEC EGOUTTOIR • ES 1 CUBA A LA IZQ. CM.34X39X19,5H CON ESCURRIDOR cm. 90x 60x 5h				545,00 18.5 / 0,22
L/691 DX 01330901	1 VASCA DX cm.34x39x19,5h CON SGOCCIOLATOIO EN 1 BOWL RIGHT cm.34x39x19,5h WITH DRAINING BOARD • DE 1 BECKEN RECHT cm.34x39x19,5h MIT ABTROPFFLACHE • FR 1 BAC A DROITE cm.34x39x19,5h AVEC EGOUTTOIR • ES 1 CUBA A LA DERECHA CM.34X39X19,5H CON ESCURRIDOR cm. 90x 60x 5h				545,00 18.5 / 0,22

MOD. COD.	DESCRIZIONE/DESCRIPTION/BEZEICHNUNG/DESCRIPTION/DESCRIPCIÓN DIMENSIONI/DIMENSIONS/ABMESSUNGEN/DIMENSIONES/DIMENSIONES	POTENZA/POWER/LEISTUNG/PUISSANCE/POTENCIA VOLTAGGIO/VOLTAGE/SPANNUNG/VOLTAGE/VOLTAJE	Ⓚ kcal/h	Ⓚ V~ Hz	PREZZO/PRICE € PREIS/PRIX/PRECIO KG / M ³
L/692 01330905	2 VASCHE cm.34x39x19,5h EN 2 BOWLS cm.34x39x19,5h • DE 2 BECKEN cm.34x39x19,5h • FR 2 BACS cm.34x39x19,5h • ES 2 CUBAS CM.34X39X19,5H cm. 90x 60x 5h				662,00 18.5 / 0,22
L/6105SX 01331052	1 VASCA SX cm.34x39x19,5h CON SGOCCIOLATOIO EN 1 BOWL LEFT cm.34x39x19,5h WITH DRAINING BOARD • DE 1 BECKEN LINKS cm.34x39x19,5h MIT ABTROPFFLACHE • FR 1 BAC A GAUCHE cm.34x39x19,5h AVEC EGOUTTOIR • ES 1 CUBA A LA IZQ. CM.34X39X19,5H CON ESCURRIDOR cm. 105x 60x 5h				599,00 21,5 / 0,25
L/6105DX 01331051	1 VASCA DX cm.34x39x19,5h CON SGOCCIOLATOIO EN 1 BOWL RIGHT cm.34x39x19,5h WITH DRAINING BOARD • DE 1 BECKEN RECHT cm.34x39x19,5h MIT ABTROPFFLACHE • FR 1 BAC A DROITE cm.34x39x19,5h AVEC EGOUTTOIR • ES 1 CUBA A LA DERECHA CM.34X39X19,5H CON ESCURRIDOR cm. 105x 60x 5h				599,00 21,5 / 0,25
L/6121SX 01331202	1 VASCA SX cm.34x39x19,5h CON SGOCCIOLATOIO EN 1 BOWL LEFT cm.34x39x19,5h WITH DRAINING BOARD • DE 1 BECKEN LINKS cm.34x39x19,5h MIT ABTROPFFLACHE • FR 1 BAC A GAUCHE cm.34x39x19,5h AVEC EGOUTTOIR • ES 1 CUBA A LA IZQ. CM.34X39X19,5H CON ESCURRIDOR cm. 120x 60x 5h				659,00 24 / 0,28
L/6121DX 01331201	1 VASCA DX cm.34x39x19,5h CON SGOCCIOLATOIO EN 1 BOWL RIGHT cm.34x39x19,5h WITH DRAINING BOARD • DE 1 BECKEN RECHT cm.34x39x19,5h MIT ABTROPFFLACHE • FR 1 BAC A DROITE cm.34x39x19,5h AVEC EGOUTTOIR • ES 1 CUBA A LA DERECHA CM.34X39X19,5H CON ESCURRIDOR cm. 120x 60x 5h				659,00 24 / 0,28
L/6122SX 01331204	2 VASCHE SX cm.34x39x19,5h CON SGOCCIOLATOIO EN 2 BOWLS LEFT cm.34x39x19,5h WITH DRAINING BOARD • DE 2 BECKEN LINKS cm.34x39x19,5h MIT ABTROPFFLACHE • FR 2 BACS A GAUCHE cm.34x39x19,5h AVEC EGOUTTOIR • ES 2 CUBAS A LA IZQ. CM.34X39X19,5H CON ESCURRIDOR cm. 120x 60x 5h				783,00 25 / 0,28
L/6122DX 01331203	2 VASCHE DX cm.34x39x19,5h CON SGOCCIOLATOIO EN 2 BOWLS RIGHT cm.34x39x19,5h WITH DRAINING BOARD • DE 2 BECKEN RECHT cm.34x39x19,5h MIT ABTROPFFLACHE • FR 2 BACS A DROITE cm.34x39x19,5h AVEC EGOUTTOIR • ES 2 CUBAS A LA DERECHA CM.34X39X19,5H CON ESCURRIDOR cm. 120x 60x 5h				783,00 25 / 0,28
L/6135SX 01331354	2 VASCHE SX cm.34x39x19,5h CON SGOCCIOLATOIO EN 2 BOWLS LEFT cm.34x39x19,5h WITH DRAINING BOARD • DE 2 BECKEN LINKS cm.34x39x19,5h MIT ABTROPFFLACHE • FR 2 BACS A GAUCHE cm.34x39x19,5h AVEC EGOUTTOIR • ES 2 CUBAS A LA IZQ. CM.34X39X19,5H CON ESCURRIDOR cm. 135x 60x 5h				840,00 28 / 0,32

LAVELLI

MOD. COD.	DESCRIZIONE/DESCRIPTION/BEZEICHNUNG/DESCRIPTION/DESCRIPCIÓN DIMENSIONI/DIMENSIONS/ABMESSUNGEN/DIMENSIONS/DIMENSIONES	POTENZA/POWER/LEISTUNG/PUISSANCE/POTENCIA VOLTAGGIO/VOLTAGE/SPANNUNG/VOLTAGE/VOLTAJE	$\frac{kW}{kcal/h}$ $\frac{V}{Hz}$	PREZZO/PRICE € KG / M ³
L/6135DX 01331353	2 VASCHE DX cm.34x39x19,5h CON SGOCCIOLATOIO EN 2 BOWLS RIGHT cm.34x39x19,5h WITH DRAINING BOARD • DE 2 BECKEN RECHT cm.34x39x19,5h MIT ABTROPFFLACHE • FR 2 BACS A DROITE cm.34x39x19,5h AVEC EGOUTTOIR • ES 2 CUBAS A LA DERECHA CM.34X39X19,5H CON ESCURRIDOR cm. 135x 60x 5h			840,00 28 / 0,32
L/6150SX 01331504	2 VASCHE SX cm.34x39x19,5h CON SGOCCIOLATOIO EN 2 BOWLS LEFT cm.34x39x19,5h WITH DRAINING BOARD • DE 2 BECKEN LINKS cm.34x39x19,5h MIT ABTROPFFLACHE • FR 2 BACS A GAUCHE cm.34x39x19,5h AVEC EGOUTTOIR • ES 2 CUBAS A LA IZQ. CM.34X39X19,5H CON ESCURRIDOR cm. 150x 60x 5h			904,00 30.5 / 0,35
L/6150DX 01331503	2 VASCHE DX cm.34x39x19,5h CON SGOCCIOLATOIO EN 2 BOWLS RIGHT cm.34x39x19,5h WITH DRAINING BOARD • DE 2 BECKEN RECHT cm.34x39x19,5h MIT ABTROPFFLACHE • FR 2 BACS A DROITE cm.34x39x19,5h AVEC EGOUTTOIR • ES 2 CUBAS A LA DERECHA CM.34X39X19,5H CON ESCURRIDOR cm. 150x 60x 5h			904,00 30.5 / 0,35
LA/680 01340800	1 VASCA cm.50x40x20h EN 1 BOWL cm.50x40x20h • DE 1 BECKEN cm.50x40x20h • FR 1 BAC cm.50x40x20h • ES 1 CUBA CM.50X40X20H cm.80/80x 60x 5h			762,00 19 / 0,26
PP/630SX 01210301	PENSILE CON PORTA E RIPIANO INTERMEDIO EN WALL UNIT WITH DOOR , AND MIDDLE SHELF • DE WANDHANGESCHRANK MIT TUR , UND ZWISCHENBORD • FR ARMOIRE SUSPENDUE AVEC PORTE ET ETAGERE INTERMEDIAIRE • ES ARMARIO DE PARED CON PUERTA Y ESTANTE INTERMEDIO cm. 30x 40x 69h			564,00 16 / 0,17
PP/640SX 01210401	cm. 40x 40x 69h			582,00 19 / 0,21
PP/645SX 01210451	cm. 45x 40x 69h			598,00 20.5 / 0,23
PP/650SX 01210501	cm. 50x 40x 69h			615,00 22 / 0,25
PP/630DX 01210300	cm. 30x 40x 69h			564,00 16 / 0,17
PP/640DX 01210400	cm. 40x 40x 69h			582,00 19 / 0,21
PP/645DX 01210450	cm. 45x 40x 69h			598,00 20.5 / 0,23
PP/650DX 01210500	cm. 50x 40x 69h			615,00 22 / 0,25

PENSILI

MOD. _____ DESCRIZIONE/DESCRIPTION/BEZEICHNUNG/DESCRIPTION/DESCRIPCIÓN POTENZA/POWER/LEISTUNG/PUISSANCE/POTENCIA $\frac{kW}{kcal/h}$ $\frac{V}{Hz}$ PREZZO/PRICE €
 COD. _____ DIMENSIONI/DIMENSIONS/ABMESSUNGEN/DIMENSIONS/DIMENSIONES VOLTAGGIO/VOLTAGE/SPANNUNG/VOLTAGE/VOLTAJE PREIS/PRIX/PRECIO KG / M³

PP/660 PENSILE CON PORTE, GUARNIZIONE E RIPIANO INTERMEDIO **773,00**
 01210600 **EN** WALL UNIT WITH DOORS , GASKET AND MIDDLE SHELF • **DE** WANDHANGESCHRANK MIT TUREN , TURDICHTUNGEN UND ZWISCHENBORD • **FR** ARMOIRE SUSPENDUE AVEC PORTES, JOINT DE PORTE ET ETAGERE INTERMEDIAIRE • **ES ARMARIO DE PARED CON PUERTAS, GUARNICION Y ESTANTE INTERMEDIO** **26 / 0,30**
cm. 60x 40x 69h

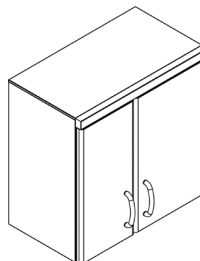

PP/670 **cm. 70x 40x 69h** **804,00**
 01210700 **29 / 0,34**

PP/680 **cm. 80x 40x 69h** **836,00**
 01210800 **33 / 0,38**

PP/690 **cm. 90x 40x 69h** **884,00**
 01210900 **36 / 0,43**

PP/6100 **cm. 100x 40x 69h** **917,00**
 01211000 **39 / 0,47**

PP/6105 PENSILE CON 3 PORTE, GUARNIZIONI E RIPIANO INTERMEDIO **1.101,00**
 01211050 **EN** WALL UNIT WITH 3 DOORS , GASKET AND MIDDLE SHELF • **DE** WANDHANGESCHRANK MIT 3 TUREN , TURDICHTUNGEN UND ZWISCHENBORD • **FR** ARMOIRE SUSPENDUE AVEC 3 PORTES, JOINT DE PORTE ET ETAGERE INTERMEDIAIRE • **ES ARMARIO DE PARED CON 3 PUERTAS, GUARNICION Y ESTANTE INTERMEDIO** **40.5 / 0,49**
cm. 105x 40x 69h

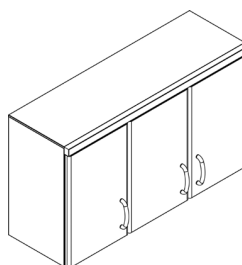

PP/6110 **cm. 110x 40x 69h** **1.120,00**
 01211100 **42 / 0,51**

PP/6120 **cm. 120x 40x 69h** **1.153,00**
 01211200 **45 / 0,56**

PP/6125 **cm. 125x 40x 69h** **1.173,00**
 01211250 **46.5 / 0,58**

PP/6135 **cm. 135x 40x 69h** **1.236,00**
 01211350 **49.5 / 0,62**

PP/6150 **cm. 150x 40x 69h** **1.303,00**
 01211500 **53 / 0,69**

PPS/660 PENSILE SCOLAPIATTI CON PORTE, GUARNIZIONE E PORTAPIATTI **969,00**
 01230600 **EN** WALL UNIT PLATE RACK WITH DOORS, GASKETS AND PLATE RACK • **DE** WANDHANGESCHRANK FÜR TELLER MIT FLUGELTUREN UND TURDICHTUNGEN • **FR** ARMOIRE EGOUTTOIR SUSPENDUE AVEC PORTES JOINTS DE PORTE, GRILLE INTERMEDIAIRE PORTE-ASSIETTES • **ES ARMARIO DE PARED ESCURRIDOR CON PUERTA Y GUARNICION** **26 / 0,30**
cm. 60x 40x 69h

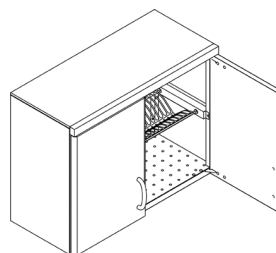

PPS/690 **cm. 90x 40x 69h** **1.061,00**
 01230900 **34 / 0,43**

PENSILI

MOD. _____
COD. _____

DESCRIZIONE/DESCRIPTION/BEZEICHNUNG/DESCRIPTION/DESCRIPCIÓN
DIMENSIONI/DIMENSIONS/ABMESSUNGEN/DIMENSIONS/DIMENSIONES

POTENZA/POWER/LEISTUNG/PUISSANCE/POTENCIA
VOLTAGGIO/VOLTAGE/SPANNUNG/VOLTAGE/VOLTAGE

$\frac{kW}{kcal/h}$ $\frac{V}{Hz}$

PREZZO/PRICE €
PREIS/PRIX/PRECIO €
KG / M³

PPA/680
01260801

PENSILE AD ANGOLO CON PORTA E RIPIANO INTERMEDIO
EN CORNER WALL UNIT WITH DOOR AND MIDDLE SHELF • **DE** ECK-WANDHANGESCHRANK MIT FLUGELTURE UND ZWISCHENBORD • **FR** ARMOIRE D'ANGLE SUSPENDUE AVEC 2 PORTES ET ETAGERE INTERMEDIAIRE • **ES ARMARIO ANGULAR DE PARED CON PUERTA Y ESTANTE INTERMEDIO**
cm.80/80x 40x 69h

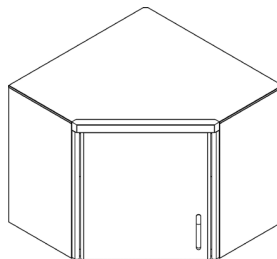

1.290,00
38 / 0,70

PPV/630SX
01220301

PENSILE CON PORTA VETRO E RIPIANO INTERMEDIO
EN WALL UNIT WITH GLASS DOOR AND MIDDLE SHELF • **DE** WANDHANGESCHRANK MIT GLASTUR UND ZWISCHENBORD • **FR** ARMOIRE SUSPENDUE AVEC PORTE VITREE ET ETAGERE INTERMEDIAIRE • **ES ARMARIO DE PARED CON PUERTA VIDRIERA Y ESTANTE INTERMEDIO**
cm. 30x 40x 69h

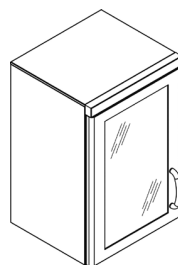

624,00
16.5 / 0,17

PPV/645SX **cm. 45x 40x 69h**
01220451

PPV/630DX **cm. 30x 40x 69h**
01220300

PPV/645DX **cm. 45x 40x 69h**
01220450

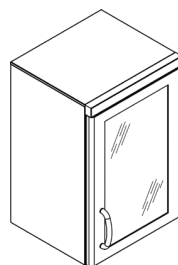

687,00
21 / 0,23

624,00
16.5 / 0,17

687,00
21 / 0,23

PPV/660
01220600

PENSILE CON PORTE VETRO, GUARNIZIONE E RIPIANO INTERMEDIO
EN WALL UNIT WITH GLASS DOORS, GASKET AND MIDDLE SHELF • **DE** WANDHANGESCHRANK MIT 2 GLASTURE, TURDICHTUNG UND ZWISCHENBORD • **FR** ARMOIRE SUSPENDUE AVEC 2 PORTES VITREE , JOINT DE PORTE ET ETAGERE INTERMEDIAIRE • **ES ARMARIO DE PARED CON PUERTAS VIDRIERA, GUARNICION Y ESTANTE INTERMEDIO**
cm. 60x 40x 69h

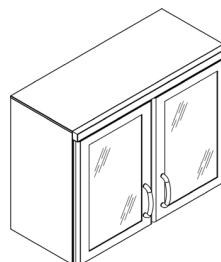

878,00
27 / 0,30

PPV/690 **cm. 90x 40x 69h**
01220900

PPV/6105
01221050

PENSILE CON 3 PORTE VETRO, GUARNIZIONI E RIPIANO INTERMEDIO
EN WALL UNIT WITH 3 GLASS DOORS, GASKETS AND MIDDLE SHELF • **DE** WANDHANGESCHRANK MIT 3 GLASTURE, TURDICHTUNG UND ZWISCHENBORD • **FR** ARMOIRE SUSPENDUE AVEC 3 PORTES VITREE , JOINT DE PORTE ET ETAGERE INTERMEDIAIRE • **ES ARMARIO DE PARED CON 3 PUERTAS VIDRIERA, GUARNICION Y ESTANTE INTERMEDIO**
cm. 105x 40x 69h

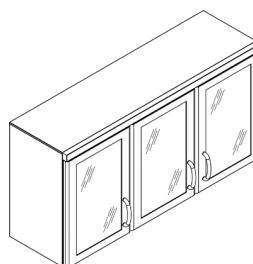

1.289,00
42 / 0,49

PPV/6135 **cm. 135x 40x 69h**
01221350

1.485,00
51 / 0,62

ARMADI

MOD. COD.	DESCRIZIONE/DESCRIPTION/BEZEICHNUNG/DESCRIPTION/DESCRIPCIÓN DIMENSIONI/DIMENSIONS/ABMESSUNGEN/DIMENSIONS/DIMENSIONES	POTENZA/POWER/LEISTUNG/PUISSANCE/POTENCIA VOLTAGGIO/VOLTAGE/SPANNUNG/VOLTAGE/VOLTAJE	$\frac{kW}{kcal/h}$ / $\frac{kW}{V}$ $\frac{Hz}{Hz}$	PREZZO/PRICE PREIS/PRIX/PRECIO € KG / M ³
A/660 01160600	ARMADIO CON PORTE, GUARNIZIONI E 4 RIPIANI INTERMEDI EN TWIN UNIT WITH DOORS, GASKET AND 4 MIDDLE SHELVES • DE HOCHSCHRANK MIT TUREN, TURDICHTUNGEN UND 4 ZWISCHENBORDE • FR ARMOIRE A PORTES, JOINT DE PORTE ET 4 ETAGERES INTERMEDIAIRES • ES ARMARIO CON PUERTAS, GUARNICIONES Y 4 ESTANTES INTERMEDIOS cm. 60x 60x 220h			2.055,00 70 / 1,07
A/690 01160900	cm. 90x 60x 220h			2.466,00 99 / 1,52
AV/660 01170600	ARMADIO CON PORTE VETRO, GUARNIZIONI E 4 RIPIANI INTERMEDI EN TWIN UNIT WITH GLASS DOORS, GASKETS AND 4 MIDDLE SHELVES • DE HOCHSCHRANK MIT 4 GLASTUREN, TURDICHTUNGEN UND 4 ZWISCHENBORDE • FR ARMOIRE AVEC PORTES VITREES, JOINTES DE PORTE ET 4 ETAGERES INTERMEDIAIRES • ES ARMARIO CON PUERTAS VIDRIERA, GUARNICIONES Y 4 ESTANTES INTERMEDIOS cm. 60x 60x 220h			2.222,00 73 / 1,07
AV/690 01170900	cm. 90x 60x 220h			2.638,00 102 / 1,52
KSK/660 01280600	CAPPA STILE CON PARETE E MENSOLA, ASPIRAZIONE AUTOFILTRANTE E CARBONI ATTIVI, 2 VELOCITA' E LUCE EN SELFILTER ETRACTOR HOOD WITH WALL AND BRACKET, ACTIVATED CHARCOAL, 2 SPEED MOTOR AND LIGHT. • DE SELBSTFILTRIERENDE ABZUGSHAUBE MIT KOHLEAKTIVFILTERN, 2-STUFEN GEBLASE, BELEUCHTUNG, WANDVERKLEIDUNG UND KONSOLE. • FR HOTTE D'ASPIRATION DE STYLE AUTOFILTRANTE, AU CHARBON ACTIF, MOTEUR 2 VITESSES, LUMIERE, PAROIR ET ATAGERE • ES CAMPANA EXTRACTORA CON PARED Y REPISA, CON ASPIRACION AUTOFILTRANTE Y CARBONES ACTIVOS, 2 VELOCIDADES Y LUZ. cm. 60x 60x 70h		$\frac{0,22 \text{ KW}}{230V\sim}$ 50 Hz	1.169,00 23 / 0,41
KSK/690 01280900	cm. 90x 60x 70h		$\frac{0,22 \text{ KW}}{230V\sim}$ 50 Hz	1.359,00 32 / 0,60
KSK/6100 01281000	cm. 100x 60x 70h		$\frac{0,22 \text{ KW}}{230V\sim}$ 50 Hz	1.575,00 33 / 0,67

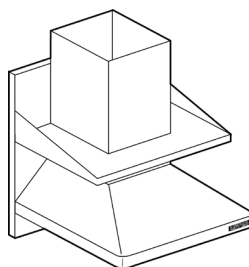
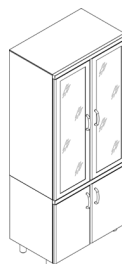

ACCESSORI

MOD. COD.	DESCRIZIONE/DESCRIPTION/BEZEICHNUNG/DESCRIPTION/DESCRIPCIÓN DIMENSIONI/DIMENSIONS/ABMESSUNGEN/DIMENSIONS/DIMENSIONES	POTENZA/POWER/LEISTUNG/PUISSANCE/POTENCIA VOLTAGGIO/VOLTAGE/SPANNUNG/VOLTAGE/VOLTAJE	⚡ kcal/h	⚡ V~ Hz	PREZZO/PRICE € PREIS/PRIX/PRECIO € KG / M ³
SP/630 01400300	SCHIENA SOTTO PENSILI EN SPLASH BACK FOR WALL UNIT • DE RUCKWAND FÜR HOCHSCHRANK • FR FINITION DOS POUR ARMOIRES SUSPENDUE • ES ESPALDA DEBAJO DE ARMADIO DE PARED cm. 30x 0,2x 62,5h				68,00 1.3 / 0,00
SP/640 01400400	cm. 40x 0,2x 62,5h				89,00 1.8 / 0,01
SP/645 01400450	cm. 45x 0,2x 62,5h				101,00 2 / 0,01
SP/650 01400500	cm. 50x 0,2x 62,5h				112,00 2.2 / 0,01
SP/670 01400700	cm. 70x 0,2x 62,5h				141,00 3.1 / 0,01
SP-SK/680 01400800	cm. 80x 0,2x 80h				161,00 4.5 / 0,01
SP/6105 01401050	cm. 105x 0,2x 62,5h				211,00 4.6 / 0,01
SP/6110 01401100	cm. 110x 0,2x 62,5h				220,00 4.8 / 0,02
SP-SK/6120 01401200	cm. 120x 0,2x 80h				241,00 6.7 / 0,02
SP/6125 01401250	cm. 125x 0,2x 62,5h				250,00 5.5 / 0,02
SP/6135 01401350	cm. 135x 0,2x 62,5h				271,00 5.9 / 0,02
SP-SK/6150 01401500	cm. 150x 0,2x 80h				301,00 8.4 / 0,03
SP-SK/660 01400600	SCHIENA SOTTO PENSILI E CAPPE KSK EN SPLASH BACK FOR WALL UNIT AND HOOD KSK • DE RUCKWAND FÜR HOCHSCHRANK UND HAUBE KSK • FR FINITION DOS POUR ARMOIRES SUSPENDUE ET HOTTE KSK • ES ESPALDA DEBAJO DE ARMADIO DE PARED Y CAMPANA KSK cm. 60x 0,2x 80h				120,00 3.4 / 0,01
SP-SK/690 01400900	cm. 90x 0,2x 80h				181,00 5 / 0,02
SP-SK/6100 01401000	cm. 100x 0,2x 80h				201,00 5.6 / 0,02

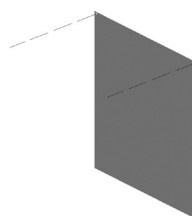
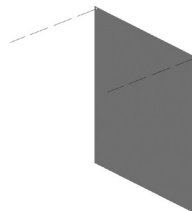

ACCESSORI

MOD. _____ DESCRIZIONE/DESCRIPTION/BEZEICHNUNG/DESCRIPTION/DESCRIPCIÓN POTENZA/POWER/LEISTUNG/PUISSANCE/POTENCIA $\frac{\text{kcal}}{\text{h}}$ $\frac{\text{kW}}{\text{h}}$ PREZZO/PRICE €
 COD. _____ DIMENSIONI/DIMENSIONS/ABMESSUNGEN/DIMENSIONS/DIMENSIONES VOLTAGGIO/VOLTAGE/SPANNUNG/VOLTAGE/VOLTAJE $\frac{\text{V}}{\text{Hz}}$ PREIS/PRIX/PRECIO €
 KG / M³

ZB ZOCOLATURA BASE **121,00**
 01410000 **EN FRONT PLINTH • DE GRUNDSOCKEL • FR** /
PLINTHE FRONTAL • ES ZOCOLOS BASE
€/mt x cm. 15h

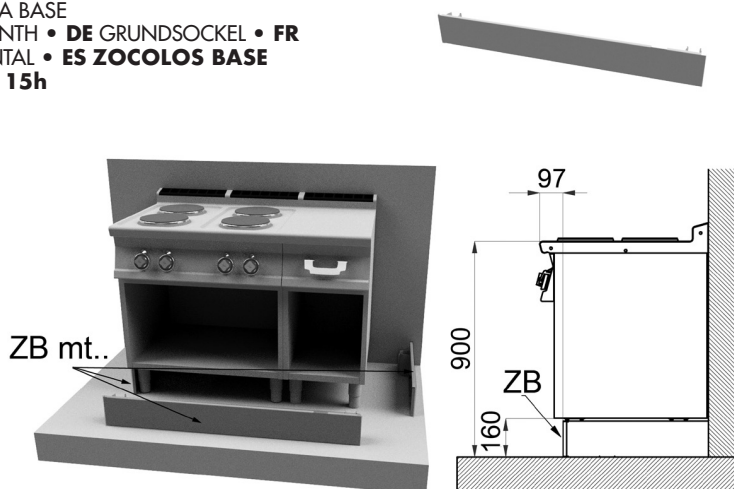

ZA ZOCOLATURA ANGOLO **74,00**
 01410002 **EN CORNER PLINTH • DE EKE-SOCKEL • FR PLINTHE** 0.3 / 0,01
ANGLE • ES ZOCOLOS ANGULAR
cm. 15h

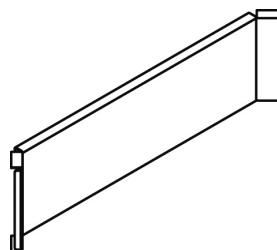

PC PP/630 PROTEZIONE CAVO FARETTO **18,00**
 01430300 **EN CABLE PROTECTION OF SMALL LAMP** / 0,00
• DE SCHUTZKABEL VOM SCHEINWERFER
• FR PROTECTION CABLE POUR LAMP • ES
PROTECCION CABLE PUNTO DE LUZ
cm. 30x 1,2x 2,9h

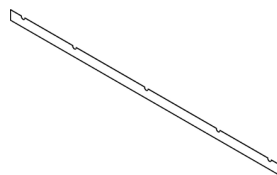

PC PP/640 cm. 40x 1,2x 2,9h **24,00**
 01430400 / 0,00

PC PP/645 cm. 45x 1,2x 2,9h **26,00**
 01430450 / 0,00

PC PP/650 cm. 50x 1,2x 2,9h **28,00**
 01430500 / 0,00

PC PP/660 cm. 60x 1,2x 2,9h **35,00**
 01430600 / 0,00

PC PP/670 cm. 70x 1,2x 2,9h **38,00**
 01430700 / 0,00

PC PP/680 cm. 80x 1,2x 2,9h **45,00**
 01430800 / 0,00

PC PP/690 cm. 90x 1,2x 2,9h **48,00**
 01430900 / 0,00

PC PP/6100 cm. 100x 1,2x 2,9h **52,00**
 01431000 / 0,00

PC PP/6105 cm. 105x 1,2x 2,9h **58,00**
 01431050 / 0,00

ACCESSORI

MOD. COD.	DESCRIZIONE/DESCRIPTION/BEZEICHNUNG/DESCRIPTION/DESCRIPCIÓN DIMENSIONI/DIMENSIONS/ABMESSUNGEN/DIMENSIONS/DIMENSIONES	POTENZA/POWER/LEISTUNG/PUISSANCE/POTENCIA VOLTAGGIO/VOLTAGE/SPANNUNG/VOLTAGE/VOLTAGE	$\frac{kW}{kcal/h}$ $\frac{kW}{V \cdot Hz}$	PREZZO/PRICE € PREIS/PRIX/PRECIO € KG / M ³
PC PP/6110 01431100	cm. 110x 1,2x 2,9h			61,00 / 0,00
PC PP/6120 01431200	cm. 120x 1,2x 2,9h			72,00 / 0,00
PC PP/6125 01431250	cm. 125x 1,2x 2,9h			76,00 / 0,00
PC PP/6135 01431350	cm. 135x 1,2x 2,9h			84,00 / 0,00
PC PP/6150 01431500	cm. 150x 1,2x 2,9h			91,00 / 0,00
KIT FARETTO 01420000	KIT FARETTO LED 1,3W L2000 (FARETTO,GHIERA,STAFFA) EN KIT SMALL LAMP LED 1,3W L2000 • DE KIT SCHEINWERFER LED 1,3W L2000 • FR KIT LAMPE LED 1,3W L2000 • ES PUNTO DE LUZ LED 1,3W L2000		$\frac{0,001 \text{ KW}}{12V \sim}$ 50/60 Hz	135,00 / 0,00
TRASFORMATORE 01420001	TRASFORMATORE 230V-12V MAX 6 INGRESSI LED EN TRANSFORMER 230V-12V MAX 6 LED • DE VERWANDLER 230V-12V MAX 6 LED • FR TRANSFORMATEUR 230V-12V MAX 6 LED • ES TRANSFORMADOR DE CORRIENTE 230V-12V MAX 6 LED			74,00 / 0,00
PROLUNGA BT 01420002	PROLUNGA 12V L1500 EN EXTENSION 12V-L1500 • DE FORTSATZT 12V L1500 • FR RALLONGE 12V L1500 • ES EXTENSIÓN 12V L1500			41,00 / 1,00
EROS4 _EROS004	GRUPPO RUBINETTO DOCCIA A LEVA EN TAP FOR SINK WITH SHOWER • DE MISCHBATTERIE • FR GROUPE ROBINET AVEC DOUCHE • ES GRUPO GRIFO CON DUCHA cm. 27x 45h			290,00 2 / 0,01
GL 51262000	GRUPPO RUBINETTO A LEVA, A NORME IGENICHE EN LEVER TAP FOR SINK IN ACCORDANCE WITH SANITARY REGULATIONS • DE EINHEBEL- MISCHBATTERIE • FR GROUPE ROBINET A LEVIER, AUX NORMES HYGIENIQUES • ES GRUPO GRIFO CON PALANCA SEGUN NORMAS HIGIENICAS cm. 21x 24h			163,00 1 / 0,00

ACCESSORI

MOD. COD.	DESCRIZIONE/DESCRIPTION/BEZEICHNUNG/DESCRIPTION/DESCRIPCIÓN DIMENSIONI/DIMENSIONS/ABMESSUNGEN/DIMENSIONS/DIMENSIONES	POTENZA/POWER/LEISTUNG/PUISSANCE/POTENCIA VOLTAGGIO/VOLTAGE/SPANNUNG/VOLTAGE/VOLTAJE	$\frac{\text{kcal}}{\text{h}}$ / $\frac{\text{kw}}{\text{h}}$ $\frac{\text{V}}{\text{Hz}}$	PREZZO/PRICE € KG / M ³
SER 01440000	KIT SERRATURA CON CHIAVE PER PORTA EN KIT LOCK WITH KEYS FOR DOOR • DE KIT SCHLOSS KT SCHLUSSEL FUR TUR • FR SERRURE AVEC CLES POUR PORTE • ES CERRADURA CON LLAVE PARA PUERTA			52,00 /

