

60 MAGICLOTUS



60 MAGICLOTUS

CUCINE ELETTRICHE
EN ELECTRIC COOKERS DE ELEKTRO HERDE FR FOURNEAU ÉLECTRIQUE ES COCINA ELECTRICAS
CFM4-66ET/V
 06660632

CUCINA ELETTRICA TRIFASE CON 4 PIASTRE FORNO ELETTRICO MULTIFUNZIONE CAMERA CM. 46X37X35H, TEMP: 50÷250°C, CON 1 GRIGLIA CM.41X32,5 - PORTA VETRO

- EN** Range threephase - N. 4 plates Multifunction electric oven Chamber cm. 46x37x35h, temp: 50÷250°C, with 1 grid cm.41x32,5 - Glass door
- DE** Elektroherd dreiphasig - N. 4 Kochplatten Multifunktions-Elektroofen - cm. 46x37x35h, temp: 50÷250°C, mit 1 Rost cm.41x32,5 - Glastür
- FR** Cuisinière triphase - N. 4 plaques Four électrique à fonctions multiples - cm. 46x37x35h, temp: 50÷250°C, avec 1 grille cm.41x32,5 - Porte vitrée

ES COCINA TRIFÁSICA - N. 4 PLANCHAS HORNO ELÉCTRICO MULTIFUNCIONAL - CÁMARA CM. 46X37X35H, TEMP: 50÷250°C, CON 1 PARILLA CM.41X32,5 - PUERTA VIDRIO

- cm. 60 x 60 x 90h
- cm. 63 x 67 x 111h / kg 70 / m³ 0,469

 ⚡ 9,05 kW
 400V~3N
 230V~3
 230V~
 50/60 Hz

€ 3.543,00

CFM4-66ET
 06660633

CUCINA ELETTRICA TRIFASE CON 4 PIASTRE FORNO ELETTRICO MULTIFUNZIONE CAMERA CM. 46X37X35H, TEMP: 50÷250°C, CON 1 GRIGLIA CM.41X32,5 - PORTA CIECA INOX

- EN** Range threephase - N. 4 plates Multifunction electric oven Chamber cm. 46x37x35h, temp: 50÷250°C, with 1 grid cm.41x32,5 - Stainless steel door
- DE** Elektroherd dreiphasig - N. 4 Kochplatten Multifunktions-Elektroofen - cm. 46x37x35h, temp: 50÷250°C, mit 1 Rost cm.41x32,5 - Edelstahltür
- FR** Cuisinière triphase - N. 4 plaques Four électrique à fonctions multiples - cm. 46x37x35h, temp: 50÷250°C, avec 1 grille cm.41x32,5 - Porte acier inoxydable

ES COCINA TRIFÁSICA - N. 4 PLANCHAS HORNO ELÉCTRICO MULTIFUNCIONAL - CÁMARA CM. 46X37X35H, TEMP: 50÷250°C, CON 1 PARILLA CM.41X32,5 - PUERTA CIEGA INOX

- cm. 60 x 60 x 90h
- cm. 63 x 67 x 111h / kg 70 / m³ 0,469

 ⚡ 9,05 kW
 400V~3N
 230V~3
 230V~
 50/60 Hz

€ 3.543,00

CFMC4-66ET/V
 06670632



CUCINA CON PIANO IN VETROCERAMICA VETRO CM. 58X44 FORNO MULTIFUNZIONE - CAMERA CM. 46X37X35H, TEMP: 50÷250°C, CON 1 GRIGLIA CM.41X32,5 - PORTA VETRO

- EN** Range threephase - Ceramic, Glass: cm. 58x44 Multifunction oven - Chamber cm. 46x37x35h, temp: 50÷250°C, with 1 grid cm.41x32,5 - Glass door
- DE** Elektroherd dreiphasig - Ceran-Kochfläche cm. 58x44 Multifunktions-Ofen - cm. 46x37x35h, temp: 50÷250°C, mit 1 Rost cm.41x32,5 - Glastür
- FR** Cuisinière triphase - Vitrocéramique Plaque cm. 58x44 Four à fonctions multiples - cm. 46x37x35h, temp: 50÷250°C, avec 1 grille cm.41x32,5 - Porte vitrée

ES COCINA TRIFÁSICA - PLACA VITROCERÁMICA, CRISTAL CM. 58X44 HORNO MULTIFUNCIONAL - CÁMARA CM. 46X37X35H, TEMP: 50÷250°C, CON 1 PARILLA CM.41X32,5 - PUERTA VIDRIO

- cm. 60 x 60 x 90h
- cm. 63 x 67 x 111h / kg 70 / m³ 0,469

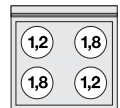
 ⚡ 9,05 kW
 400V~3N
 230V~3
 230V~
 50/60 Hz

€ 5.459,00

CFMC4-66ET
 06670633



CUCINA CON PIANO IN VETROCERAMICA VETRO CM. 58X44 FORNO MULTIFUNZIONE - CAMERA CM. 46X37X35H, TEMP: 50÷250°C, CON 1 GRIGLIA CM.41X32,5 - PORTA CIECA INOX

- EN** Range threephase - Ceramic, Glass: cm. 58x44 Multifunction oven - Chamber cm. 46x37x35h, temp: 50÷250°C, with 1 grid cm.41x32,5 - Stainless steel door
- DE** Elektroherd dreiphasig - Ceran-Kochfläche cm. 58x44 Multifunktions-Ofen - cm. 46x37x35h, temp: 50÷250°C, mit 1 Rost cm.41x32,5 - Edelstahltür
- FR** Cuisinière triphase - Vitrocéramique Plaque cm. 58x44 Four à fonctions multiples - cm. 46x37x35h, temp: 50÷250°C, avec 1 grille cm.41x32,5 - Porte acier inoxydable

ES COCINA TRIFÁSICA - PLACA VITROCERÁMICA, CRISTAL CM. 58X44 HORNO MULTIFUNCIONAL - CÁMARA CM. 46X37X35H, TEMP: 50÷250°C, CON 1 PARILLA CM.41X32,5 - PUERTA CIEGA INOX

- cm. 60 x 60 x 90h
- cm. 63 x 67 x 111h / kg 70 / m³ 0,469

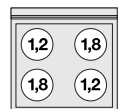
 ⚡ 9,05 kW
 400V~3N
 230V~3
 230V~
 50/60 Hz

€ 5.459,00

CF4-68ET/V

06660830



CUCINA ELETTRICA TRIFASE CON N. 4 PIASTRE - FORNO ELETTRICO STATICO CON GRILL CM. 64X42X35H, TEMP: 50÷250°C, CON 1 GRIGLIA CM.53X32,5 GN1/1 - PORTA VETRO

EN Range threephase - N. 4 plates - Static oven with grill cm. 64x42x35h, temp: 50÷250°C, with 1 grid cm.53x32,5 GN1/1 - Glass door

DE Elektroherd dreiphasig - N. 4 Kochplatten Statischer Ofen mit Grill cm. 64x42x35h, temp: 50÷250°C, mit 1 Rost cm.53x32,5 GN1/1 - Glastür

FR Cuisinière triphase - N. 4 plaques - Four statique avec grill cm. 64x42x35h, temp: 50÷250°C, avec 1 grille cm.53x32,5 GN1/1 - Porte vitrée

ES **COCINA TRIFÁSICA - N. 4 PLANCHAS - HORNO ESTÁTICO CON ASADOR CM. 64X42X35H, TEMP: 50÷250°C, CON 1 PARILLA CM.53X32,5 GN1/1 - PUERTA VIDRIO**

cm. 80 x 60 x 90h

 cm. 83 x 67 x 111h / kg 91 / m³ 0,617

8,62 kW
400V~3N
230V~3
230V~
50/60 Hz

€ 3.196,00

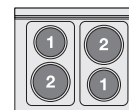
**CF4-68ET**

06660831



CUCINA ELETTRICA TRIFASE CON N. 4 PIASTRE - FORNO ELETTRICO STATICO CON GRILL CM. 64X42X35H, TEMP: 50÷250°C, CON 1 GRIGLIA CM.53X32,5 GN1/1 - PORTA CIECA INOX

EN Range threephase - N. 4 plates - Static oven with grill cm. 64x42x35h, temp: 50÷250°C, with 1 grid cm.53x32,5 GN1/1 - Stainless steel door

DE Elektroherd dreiphasig - N. 4 Kochplatten Statischer Ofen mit Grill cm. 64x42x35h, temp: 50÷250°C, mit 1 Rost cm.53x32,5 GN1/1 - Edelstahltür

FR Cuisinière triphase - N. 4 plaques - Four statique avec grill cm. 64x42x35h, temp: 50÷250°C, avec 1 grille cm.53x32,5 GN1/1 - Porte acier inoxydable

ES **COCINA TRIFÁSICA - N. 4 PLANCHAS - HORNO ESTÁTICO CON ASADOR CM. 64X42X35H, TEMP: 50÷250°C, CON 1 PARILLA CM.53X32,5 GN1/1 - PUERTA CIEGA INOX**

cm. 80 x 60 x 90h

 cm. 83 x 67 x 111h / kg 91 / m³ 0,617

8,62 kW
400V~3N
230V~3
230V~
50/60 Hz

€ 3.196,00

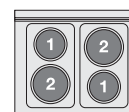
**CFM4-68ET/V**

06660832



CUCINA ELETTRICA TRIFASE CON 4 PIASTRE FORNO ELETTRICO MULTIFUNZIONE CAMERA CM. 64X37X35H, TEMP: 50÷250°C, CON 1 GRIGLIA CM.53X32,5 GN1/1 - PORTA VETRO

EN Range threephase - N. 4 plates Multifunction electric oven Chamber cm. 64x37x35h, temp: 50÷250°C, with 1 grid cm.53x32,5 GN1/1 - Glass door

DE Elektroherd dreiphasig - N. 4 Kochplatten Multifunktions-Elektroofen cm. 64x37x35h, temp: 50÷250°C, mit 1 Rost cm.53x32,5 GN1/1 - Glastür

FR Cuisinière triphase - N. 4 plaques Four électrique à fonctions multiples cm. 64x37x35h, temp: 50÷250°C, avec 1 grille cm.53x32,5 GN1/1 - Porte vitrée

ES **COCINA TRIFÁSICA - N. 4 PLANCHAS HORNO ELÉCTRICO MULTIFUNCIONAL - CÁMARA CM. 64X37X35H, TEMP: 50÷250°C, CON 1 PARILLA CM.53X32,5 GN1/1 - PUERTA VIDRIO**

cm. 80 x 60 x 90h

 cm. 83 x 67 x 111h / kg 92 / m³ 0,617

9,05 kW
400V~3N
230V~3
230V~
50/60 Hz

€ 4.225,00

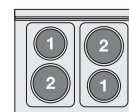
**CFM4-68ET**

06660833



CUCINA ELETTRICA TRIFASE CON 4 PIASTRE FORNO ELETTRICO MULTIFUNZIONE CAMERA CM. 64X37X35H, TEMP: 50÷250°C, CON 1 GRIGLIA CM.53X32,5 GN1/1 - PORTA CIECA INOX

EN Range threephase - N. 4 plates Multifunction electric oven Chamber cm. 64x37x35h, temp: 50÷250°C, with 1 grid cm.53x32,5 GN1/1 - Stainless steel door

DE Elektroherd dreiphasig - N. 4 Kochplatten Multifunktions-Elektroofen cm. 64x37x35h, temp: 50÷250°C, mit 1 Rost cm.53x32,5 GN1/1 - Edelstahltür

FR Cuisinière triphase - N. 4 plaques Four électrique à fonctions multiples cm. 64x37x35h, temp: 50÷250°C, avec 1 grille cm.53x32,5 GN1/1 - Porte acier inoxydable

ES **COCINA TRIFÁSICA - N. 4 PLANCHAS HORNO ELÉCTRICO MULTIFUNCIONAL - CÁMARA CM. 64X37X35H, TEMP: 50÷250°C, CON 1 PARILLA CM.53X32,5 GN1/1 - PUERTA CIEGA INOX**

cm. 80 x 60 x 90h

 cm. 83 x 67 x 111h / kg 92 / m³ 0,617

9,05 kW
400V~3N
230V~3
230V~
50/60 Hz

€ 4.225,00

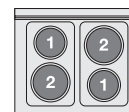
**CF6-610ET/V**

06661030



CUCINA ELETTRICA TRIFASE CON N. 6 PIASTRE - FORNO ELETTRICO STATICO CON GRILL CM. 64X42X35H, TEMP: 50÷250°C, CON 1 GRIGLIA CM.53X32,5 GN1/1 - PORTA VETRO

EN Range threephase - N. 6 plates - Static oven with grill cm. 64x42x35h, temp: 50÷250°C, with 1 grid cm.53x32,5 GN1/1 - Glass door

DE Elektroherd dreiphasig - N. 6 Kochplatten Statischer Ofen mit Grill cm. 64x42x35h, temp: 50÷250°C, mit 1 Rost cm.53x32,5 GN1/1 - Glastür

FR Cuisinière triphase - N. 6 plaques - Four statique avec grill cm. 64x42x35h, temp: 50÷250°C, avec 1 grille cm.53x32,5 GN1/1 - Porte vitrée

ES **COCINA TRIFÁSICA - N. 6 PLANCHAS - HORNO ESTÁTICO CON ASADOR CM. 64X42X35H, TEMP: 50÷250°C, CON 1 PARILLA CM.53X32,5 GN1/1 - PUERTA VIDRIO**

cm. 100 x 60 x 90h

 cm. 103 x 67 x 111h / kg 95 / m³ 0,766

11,62 kW
400V~3N
230V~3
50/60 Hz

€ 3.696,00

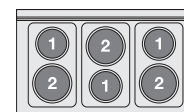

CF6-610ET

06661031



CUCINA ELETTRICA TRIFASE CON N. 6 PIASTRE - FORNO ELETTRICO STATICO CON GRILL CM. 64X42X35H, TEMP: 50÷250°C, CON 1 GRIGLIA CM.53X32,5 GN1/1 - PORTA CIEGA INOX

EN Range threephase - N. 6 plates - Static oven with grill cm. 64x42x35h, temp: 50÷250°C, with 1 grid cm.53x32,5 GN1/1 - Stainless steel door

DE Elektroherd dreiphasig - N. 6 Kochplatten Statischer Ofen mit Grill cm. 64x42x35h, temp: 50÷250°C, mit 1 Rost cm.53x32,5 GN1/1 - Edelstahltür

FR Cuisinière triphase - N. 6 plaques - Four statique avec grill cm. 64x42x35h, temp: 50÷250°C, avec 1 grille cm.53x32,5 GN1/1 - Porte acier inoxydable

ES **COCINA TRIFÁSICA - N. 6 PLANCHAS - HORNO ESTÁTICO CON ASADOR CM. 64X42X35H, TEMP: 50÷250°C, CON 1 PARILLA CM.53X32,5 GN1/1 - PUERTA CIEGA INOX**

cm. 100 x 60 x 90h
 cm. 103 x 67 x 111h / kg 95 / m³ 0,766

€ 3.696,00
 ⚡ 11,62 kW
 400V~3N
 230V~3
 50/60 Hz

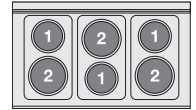
CFM6-610ET/V

06661032



CUCINA ELETTRICA TRIFASE CON 6 PIASTRE FORNO ELETTRICO MULTIFUNZIONE CAMERA CM. 64X37X35H, TEMP: 50÷250°C, CON 1 GRIGLIA CM.53X32,5 GN1/1 - PORTA VETRO

EN Range threephase - N. 6 plates Multifunction electric oven Chamber cm. 64x37x35h, temp: 50÷250°C, with 1 grid cm.53x32,5 GN1/1 - Glass door

DE Elektroherd dreiphasig - N. 6 Kochplatten Multifunktions-Elektroofen cm. 64x37x35h, temp: 50÷250°C, mit 1 Rost cm.53x32,5 GN1/1 - Glastür

FR Cuisinière triphase - N. 6 plaques Four électrique à fonctions multiples cm. 64x37x35h, temp: 50÷250°C, avec 1 grille cm.53x32,5 GN1/1 - Porte vitrée

ES **COCINA TRIFÁSICA - N. 6 PLANCHAS HORNO ELÉCTRICO MULTIFUNCIONAL - CÁMARA CM. 64X37X35H, TEMP: 50÷250°C, CON 1 PARILLA CM.53X32,5 GN1/1 - PUERTA VIDRIO**

cm. 100 x 60 x 90h
 cm. 103 x 67 x 111h / kg 96 / m³ 0,766

€ 4.918,00
 ⚡ 12,05 kW
 400V~3N
 230V~3
 50/60 Hz

CFM6-610ET

06661033



CUCINA ELETTRICA TRIFASE CON 6 PIASTRE FORNO ELETTRICO MULTIFUNZIONE CAMERA CM. 64X37X35H, TEMP: 50÷250°C, CON 1 GRIGLIA CM.53X32,5 GN1/1 - PORTA CIEGA INOX

EN Range threephase - N. 6 plates Multifunction electric oven Chamber cm. 64x37x35h, temp: 50÷250°C, with 1 grid cm.53x32,5 GN1/1 - Stainless steel door

DE Elektroherd dreiphasig - N. 6 Kochplatten Multifunktions-Elektroofen cm. 64x37x35h, temp: 50÷250°C, mit 1 Rost cm.53x32,5 GN1/1 - Edelstahltür

FR Cuisinière triphase - N. 6 plaques Four électrique à fonctions multiples cm. 64x37x35h, temp: 50÷250°C, avec 1 grille cm.53x32,5 GN1/1 - Porte acier inoxydable

ES **COCINA TRIFÁSICA - N. 6 PLANCHAS HORNO ELÉCTRICO MULTIFUNCIONAL - CÁMARA CM. 64X37X35H, TEMP: 50÷250°C, CON 1 PARILLA CM.53X32,5 GN1/1 - PUERTA CIEGA INOX**

cm. 100 x 60 x 90h
 cm. 103 x 67 x 111h / kg 96 / m³ 0,766

€ 4.918,00
 ⚡ 12,05 kW
 400V~3N
 230V~3
 50/60 Hz

CUCINE A GAS

EN GAS COOKERS **DE** GAS HERDE **FR** FOURNEAU À GAZ **ES** **COCINA A GAS**

CF4-68G/V

06680850



CUCINA A GAS 4 FUOCHI FORNO A GAS STATICO CON GRILL CM. 64X39X35H, TEMP: 125÷275°C, CON 1 GRIGLIA CM.53X32,5 GN1/1 - PORTA VETRO

EN Gas range - N. 4 burners - Gas static oven with grill cm. 64x39x35h, temp: 125÷275°C, with 1 grid cm.53x32,5 GN1/1 - glass door

DE Gasherd - N. 4 Kochstellen - Gas Statischer Backofen mit grill cm. 64x39x35h, temp: 125÷275°C, mit 1 Rost cm.53x32,5 GN1/1 - Glastür

FR Cuisinière gaz - N. 4 feux vifs - Four gaz statique avec grill cm. 64x39x35h, temp: 125÷275°C, avec 1 grille cm.53x32,5 GN1/1 - Porte vitrée

ES **COCINA GAS - N. 4 QUEMADORES - HORNO GAS ESTÁTICO CON ASADOR CM. 64X39X35H, TEMP: 125÷275°C, CON 1 PARILLA CM.53X32,5 GN1/1 - PUERTA VIDRIO**

cm. 80 x 60 x 90h
 cm. 83 x 67 x 111h / kg 97 / m³ 0,617

€ 4.032,00
 ⚡ 22 kW
 18.920 kcal/h

⚡ 0,015 kW
 230V~
 50/60 Hz

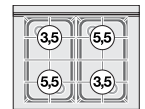

CF4-68G

06680851



CUCINA A GAS 4 FUOCHI FORNO A GAS STATICO CON GRILL CM. 64X39X35H, TEMP: 125÷275°C, CON 1 GRIGLIA CM.53X32,5 GN1/1 - PORTA CIECA INOX

EN Gas range - N. 4 burners - Gas static oven with grill cm. 64x39x35h, temp: 125÷275°C, with 1 grid cm.53x32,5 GN1/1 - Stainless steel door

DE Gasherd - N. 4 Kochstellen - Gas Statischer Backofen mit grill cm. 64x39x35h, temp: 125÷275°C, mit 1 Rost cm.53x32,5 GN1/1 - Edelstahltür/Porte acier inoxydable

FR Cuisinière gaz - N. 4 feux vifs - Four gaz statique avec grill cm. 64x39x35h, temp: 125÷275°C, avec 1 grille cm.53x32,5 GN1/1 - Porte acier inoxydable

ES **COCINA GAS - N. 4 QUEMADORES - HORNO GAS ESTÁTICO CON ASADOR CM. 64X39X35H, TEMP: 125÷275°C, CON 1 PARILLA CM.53X32,5 GN1/1 - PUERTA CIEGA INOX**

cm. 80 x 60 x 90h

cm. 83 x 67 x 111h / kg 97 / m³ 0,617

22 kW
18.920 kcal/h

€ 4.032,00

0,015 kW
230V~
50/60 Hz

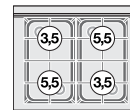
**CF2-68G**

06780851



CUCINA A GAS 2 FUOCHI FORNO A GAS STATICO CON GRILL CM. 67X38X34H, TEMP: 125÷275°C, CON 1 GRIGLIA CM.65X36

EN Gas range - N. 2 burners - Gas static oven with grill cm. 67x38x34h, temp: 125÷275°C, with 1 grid cm.65x36

DE Gasherd - N. 2 Kochstellen - Gas statischer Backofen mit Grill cm. 67x38x34h, temp: 125÷275°C, mit 1 Rost cm.65x36

FR Forneau gaz - N. 2 feux vifs - Four a gaz statique avec grill cm. 67x38x34h, temp: 125÷275°C, avec 1 grille cm.65x36

ES **COCINA GAS - N. 2 QUEMADORES HORNO A GAS ESTÁTICO CON ASADOR CM. 67X38X34H, TEMP: 125÷275°C, CON 1 PARILLA CM.65X36**

cm. 80 x 60 x 90h

cm. 83 x 67 x 111h / kg 95 / m³ 0,617

21 KW
18.060 kcal/h

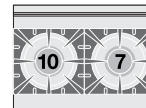
€ 4.426,00**CF6-610G/V**

06681050



CUCINA A GAS 6 FUOCHI FORNO A GAS STATICO CON GRILL CM. 64X39X35H, TEMP: 125÷275°C, CON 1 GRIGLIA CM.53X32,5 GN1/1 - PORTA VETRO

EN Gas range - N. 6 burners - Gas static oven with grill cm. 64x39x35h, temp: 125÷275°C, with 1 grid cm.53x32,5 GN1/1 - glass door

DE Gasherd - N. 6 Kochstellen - Gas statischer Backofen mit grill cm. 64x39x35h, temp: 125÷275°C, mit 1 Rost cm.53x32,5 GN1/1 - Glastür

FR Cuisinière gaz - N. 6 feux vifs - Four gaz statique avec grill cm. 64x39x35h, temp: 125÷275°C, avec 1 grille cm.53x32,5 GN1/1 - Porte vitrée

ES **COCINA GAS - N. 6 QUEMADORES - HORNO GAS ESTÁTICO CON ASADOR CM. 64X39X35H, TEMP: 125÷275°C, CON 1 PARILLA CM.53X32,5 GN1/1 - PUERTA VIDRIO**

cm. 100 x 60 x 90h

cm. 103 x 67 x 111h / kg 106 / m³ 0,766

31 kW
26.660 kcal/h

€ 4.321,00

0,015 kW
230V~
50/60 Hz

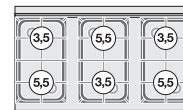
**CF6-610G**

06681051



CUCINA A GAS 6 FUOCHI FORNO A GAS STATICO CON GRILL CM. 64X39X35H, TEMP: 125÷275°C, CON 1 GRIGLIA CM.53X32,5 GN1/1 - PORTA CIECA INOX

EN Gas range - N. 6 burners - Gas static oven with grill cm. 64x39x35h, temp: 125÷275°C, with 1 grid cm.53x32,5 GN1/1 - Stainless steel door

DE Gasherd - N. 6 Kochstellen - Gas statischer Backofen mit grill cm. 64x39x35h, temp: 125÷275°C, mit 1 Rost cm.53x32,5 GN1/1 - Edelstahltür/Porte acier inoxydable

FR Cuisinière gaz - N. 6 feux vifs - Four gaz statique avec grill cm. 64x39x35h, temp: 125÷275°C, avec 1 grille cm.53x32,5 GN1/1 - Porte acier inoxydable

ES **COCINA GAS - N. 6 QUEMADORES - HORNO GAS ESTÁTICO CON ASADOR CM. 64X39X35H, TEMP: 125÷275°C, CON 1 PARILLA CM.53X32,5 GN1/1 - PUERTA CIEGA INOX**

cm. 100 x 60 x 90h

cm. 103 x 67 x 111h / kg 106 / m³ 0,766

31 kW
26.660 kcal/h

€ 4.321,00

0,015 kW
230V~
50/60 Hz

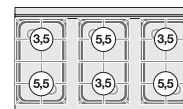
**CF3-612GV**

06781251



CUCINA A GAS 3 FUOCHI FORNO A GAS STATICO CON GRILL CM. 67X38X34H, TEMP: 125÷275°C, CON 1 GRIGLIA CM.65X36, VANO NEUTRO CON PORTA.

EN Gas range - N. 3 burners - Gas static oven with grill cm. 67x38x34h, temp: 125÷275°C, with 1 grid cm.65x36 - Neutral cabinet with door

DE Gasherd - N. 3 Kochstellen - Gas statischer Backofen mit Grill cm. 67x38x34h, temp: 125÷275°C, mit 1 Rost cm.65x36 - Neutrales Schrankelement mit Tür

FR Forneau gaz - N. 3 feux vifs - Four a gaz statique avec grill cm. 67x38x34h, temp: 125÷275°C, avec 1 grille cm.65x36 - Element neutre avec porte

ES **COCINA GAS - N. 3 QUEMADORES HORNO A GAS ESTÁTICO CON ASADOR CM. 67X38X34H, TEMP: 125÷275°C, CON 1 PARILLA CM.65X36 - ARMARIO NEUTRO CON PUERTA EQUIPADO**

cm. 120 x 60 x 90h

cm. 123 x 67 x 111h / kg 102 / m³ 0,915

31 kW
26.660 kcal/h

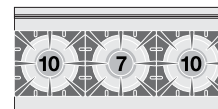
€ 5.424,00

CUCINE A GAS CON FORNO ELETTRICO
EN GAS COOKERS WITH ELECTRIC OVEN DE GAS HERDE MIT ELEKTRO-ÖFEN FR FOURNEAU À GAZ AVEC FOUR ÉLECTRIQUE ES COCINA A GAS CON HORNO ELECTRICO
CFM4-66GEM/V
 06690662

CUCINA MISTA 4 FUOCHI CON FORNO ELETTRICO MULTIFUNZIONE - CAMERA CM. 46X37X35H, TEMP: 50÷250°C, CON 1 GRIGLIA CM.41X32,5 - PORTA VETRO

EN Combined range - N. 4 burners Multifunction oven - Chamber cm. 46x37x35h, temp: 50÷250°C, with 1 grid cm.41x32,5 - Glass door

DE Gemischtherd - N. 4 Kochstellen Multifunktions-Ofen - cm. 46x37x35h, temp: 50÷250°C, mit 1 Rost cm.41x32,5 - Glastür

FR Cuisinière mixte - N. 4 feux vifs Four à fonctions multiples - cm. 46x37x35h, temp: 50÷250°C, avec 1 grille cm.41x32,5 - Porte vitrée

ES **COCINA MIXTA - N. 4 QUEMADORES HORNO MULTIFUNCIONAL - CÁMARA CM. 46X37X35H, TEMP: 50÷250°C, CON 1 PARILLA CM.41X32,5 - PUERTA VIDRIO**

cm. 60 x 60 x 90h

 cm. 63 x 67 x 111h / kg 70 / m³ 0,469

 18 kW
 15.480 kcal/h

€ 4.018,00

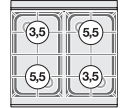
 3,05 kW
 230V~
 50/60 Hz

CFM4-66GEM
 06690663

CUCINA MISTA 4 FUOCHI CON FORNO ELETTRICO MULTIFUNZIONE - CAMERA CM. 46X37X35H, TEMP: 50÷250°C, CON 1 GRIGLIA CM.41X32,5 - PORTA CIEGA INOX

EN Combined range - N. 4 burners Multifunction oven - Chamber cm. 46x37x35h, temp: 50÷250°C, with 1 grid cm.41x32,5 - Stainless steel door

DE Gemischtherd - N. 4 Kochstellen Multifunktions-Ofen - cm. 46x37x35h, temp: 50÷250°C, mit 1 Rost cm.41x32,5 - Edelstahltür

FR Cuisinière mixte - N. 4 feux vifs Four à fonctions multiples - cm. 46x37x35h, temp: 50÷250°C, avec 1 grille cm.41x32,5 - Porte acier inoxydatable

ES **COCINA MIXTA - N. 4 QUEMADORES HORNO MULTIFUNCIONAL - CÁMARA CM. 46X37X35H, TEMP: 50÷250°C, CON 1 PARILLA CM.41X32,5 - PUERTA CIEGA INOX**

cm. 60 x 60 x 90h

 cm. 63 x 67 x 111h / kg 70 / m³ 0,469

 18 kW
 15.480 kcal/h

€ 4.018,00

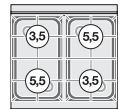
 3,05 kW
 230V~
 50/60 Hz

CF4-68GEM/V
 06690860

CUCINA MISTA 4 FUOCHI CON FORNO ELETTRICO STATICO CON GRILL CM. 64X42X35H, TEMP: 50÷250°C, CON 1 GRIGLIA CM.53X32,5 GN1/1 - PORTA VETRO

EN Combined range static oven - N. 4 burners Static oven with grill cm. 64x42x35h, temp: 50÷250°C, with 1 grid cm.53x32,5 GN1/1 - Glass door

DE Gemischtherd statischer Ofen - N. 4 Kochstellen Statischer Ofen mit Grill cm. 64x42x35h, temp: 50÷250°C, mit 1 Rost cm.53x32,5 GN1/1 - Glastür

FR Cuisinière mixte gaz four statique - N. 4 feux vifs Four statique avec grill cm. 64x42x35h, temp: 50÷250°C, avec 1 grille cm.53x32,5 GN1/1 - Porte vitrée

ES **COCINA MIXTA HORNO ESTÁTICO - N. 4 QUEMADORES HORNO ESTÁTICO CON ASADOR CM. 64X42X35H, TEMP: 50÷250°C, CON 1 PARILLA CM.53X32,5 GN1/1 - PUERTA VIDRIO**

cm. 80 x 60 x 90h

 cm. 83 x 67 x 111h / kg 97 / m³ 0,617

 18 kW
 15.480 kcal/h

€ 3.602,00

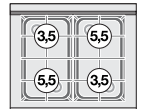
 2,62 kW
 230V~
 50/60 Hz

CF4-68GEM
 06690861

CUCINA MISTA 4 FUOCHI CON FORNO ELETTRICO STATICO CON GRILL CM. 64X42X35H, TEMP: 50÷250°C, CON 1 GRIGLIA CM.53X32,5 GN1/1 - PORTA CIEGA INOX

EN Combined range static oven - N. 4 burners Static oven with grill cm. 64x42x35h, temp: 50÷250°C, with 1 grid cm.53x32,5 GN1/1 - Stainless steel door

DE Gemischtherd statischer Ofen - N. 4 Kochstellen Statischer Ofen mit Grill cm. 64x42x35h, temp: 50÷250°C, mit 1 Rost cm.53x32,5 GN1/1 - Edelstahltür

FR Cuisinière mixte gaz four estatico - N. 4 feux vifs Four statique avec grill cm. 64x42x35h, temp: 50÷250°C, avec 1 grille cm.53x32,5 GN1/1 - Porte acier inoxydatable

ES **COCINA MIXTA HORNO ESTÁTICO - N. 4 QUEMADORES HORNO ESTÁTICO CON ASADOR CM. 64X42X35H, TEMP: 50÷250°C, CON 1 PARILLA CM.53X32,5 GN1/1 - PUERTA CIEGA INOX**

cm. 80 x 60 x 90h

 cm. 83 x 67 x 111h / kg 97 / m³ 0,617

 18 kW
 15.480 kcal/h

€ 3.602,00

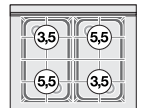
 2,62 kW
 230V~
 50/60 Hz

CFM4-68GEM/V

06690862



CUCINA MISTA 4 FUOCHI CON FORNO ELETTRICO MULTIFUNZIONE - CAMERA CM. 64X37X35H, TEMP: 50÷250°C, CON 1 GRIGLIA CM.53X32,5 GN1/1 - PORTA VETRO

EN Combined range - N. 4 burners Multifunction oven - Chamber cm. 64x37x35h, temp: 50÷250°C, with 1 grid cm.53x32,5 GN1/1 - Glass door

DE Gemischtherd - N. 4 Kochstellen Multifunktions-Ofen cm. 64x37x35h, temp: 50÷250°C, with 1 grid cm.53x32,5 GN1/1 - Glastür

FR Cuisinière mixte - N. 4 feux vifs Four à fonctions multiples cm. 64x37x35h, temp: 50÷250°C, avec 1 grille cm.53x32,5 GN1/1 - Porte vitrée

ES **COCINA MIXTA - N. 4 QUEMADORES HORNO MULTIFUNCIONAL - CÁMARA CM. 64X37X35H, TEMP: 50÷250°C, CON 1 PARILLA CM.53X32,5 GN1/1 - PUERTA VIDRIO**

cm. 80 x 60 x 90h

cm. 83 x 67 x 111h / kg 98 / m³ 0,617

18 kW
15.480 kcal/h

€ 5.112,00

3,05 kW
230V~
50/60 Hz

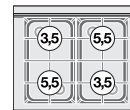
**CFM4-68GEM**

06690863



CUCINA MISTA 4 FUOCHI CON FORNO ELETTRICO MULTIFUNZIONE - CAMERA CM. 64X37X35H, TEMP: 50÷250°C, CON 1 GRIGLIA CM.53X32,5 GN1/1 - PORTA CIECA INOX

EN Combined range - N. 4 burners Multifunction oven - Chamber cm. 64x37x35h, temp: 50÷250°C, with 1 grid cm.53x32,5 GN1/1 - Stainless steel door

DE Gemischtherd - N. 4 Kochstellen Multifunktions-Ofen cm. 64x37x35h, temp: 50÷250°C, with 1 grid cm.53x32,5 GN1/1 - Edelstahltür

FR Cuisinière mixte - N. 4 feux vifs Four à fonctions multiples cm. 64x37x35h, temp: 50÷250°C, avec 1 grille cm.53x32,5 GN1/1 - Porte acier inoxydable

ES **COCINA MIXTA - N. 4 QUEMADORES HORNO MULTIFUNCIONAL - CÁMARA CM. 64X37X35H, TEMP: 50÷250°C, CON 1 PARILLA CM.53X32,5 GN1/1 - PUERTA CIEGA INOX**

cm. 80 x 60 x 90h

cm. 83 x 67 x 111h / kg 98 / m³ 0,617

18 kW
15.480 kcal/h

€ 5.112,00

3,05 kW
230V~
50/60 Hz

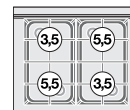
**CF6-610GEM/V**

06691060



CUCINA MISTA 6 FUOCHI CON FORNO ELETTRICO STATICO CON GRILL CM. 64X42X35H, TEMP: 50÷250°C, CON 1 GRIGLIA CM.53X32,5 GN1/1 - PORTA VETRO

EN Combined range static oven - N. 6 burners Static oven with grill cm. 64x42x35h, temp: 50÷250°C, with 1 grid cm.53x32,5 GN1/1 - Glass door

DE Gemischtherd statischer Ofen - N. 6 Kochstellen Statischer Ofen mit Grill cm. 64x42x35h, temp: 50÷250°C, mit 1 Rost cm.53x32,5 GN1/1 - Glastür

FR Cuisinière mixte gaz four statique - N. 6 feux vifs Four statique avec grill cm. 64x42x35h, temp: 50÷250°C, avec 1 grille cm.53x32,5 GN1/1 - Porte vitrée

ES **COCINA MIXTA HORNO ESTÁTICO - N. 6 QUEMADORES HORNO ESTÁTICO CON ASADOR CM. 64X42X35H, TEMP: 50÷250°C, CON 1 PARILLA CM.53X32,5 GN1/1 - PUERTA VIDRIO**

cm. 100 x 60 x 90h

cm. 103 x 67 x 111h / kg 106 / m³ 0,766

27 kW
23.193 kcal/h

€ 4.233,00

2,62 kW
230V~
50/60 Hz

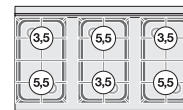
**CF6-610GEM**

06691061



CUCINA MISTA 6 FUOCHI CON FORNO ELETTRICO STATICO CON GRILL CM. 64X42X35H, TEMP: 50÷250°C, CON 1 GRIGLIA CM.53X32,5 GN1/1 - PORTA CIECA INOX

EN Combined range static oven - N. 6 burners Static oven with grill cm. 64x42x35h, temp: 50÷250°C, with 1 grid cm.53x32,5 GN1/1 - Stainless steel door

DE Gemischtherd statischer Ofen - N. 6 Kochstellen Statischer Ofen mit Grill cm. 64x42x35h, temp: 50÷250°C, mit 1 Rost cm.53x32,5 GN1/1 - Edelstahltür

FR Cuisinière mixte gaz four estatico - N. 6 feux vifs Four statique avec grill cm. 64x42x35h, temp: 50÷250°C, avec 1 grille cm.53x32,5 GN1/1 - Porte acier inoxydable

ES **COCINA MIXTA HORNO ESTÁTICO - N. 6 QUEMADORES HORNO ESTÁTICO CON ASADOR CM. 64X42X35H, TEMP: 50÷250°C, CON 1 PARILLA CM.53X32,5 GN1/1 - PUERTA CIEGA INOX**

cm. 100 x 60 x 90h

cm. 103 x 67 x 111h / kg 106 / m³ 0,766

27 kW
23.193 kcal/h

€ 4.233,00

2,62 kW
230V~
50/60 Hz

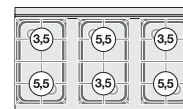
**CFM6-610GEM/V**

06691062



CUCINA MISTA 6 FUOCHI CON FORNO ELETTRICO MULTIFUNZIONE - CAMERA CM. 64X37X35H, TEMP: 50÷250°C, CON 1 GRIGLIA CM.53X32,5 GN1/1 - PORTA VETRO

EN Combined range - N. 6 burners Multifunction oven - Chamber cm. 64x37x35h, temp: 50÷250°C, with 1 grid cm.53x32,5 GN1/1 - Glass door

DE Gemischtherd - N. 6 Kochstellen Multifunktions-Ofen cm. 64x37x35h, temp: 50÷250°C, mit 1 Rost cm.53x32,5 GN1/1 - Glastür

FR Cuisinière mixte - N. 6 feux vifs Four à fonctions multiples cm. 64x37x35h, temp: 50÷250°C, avec 1 grille cm.53x32,5 GN1/1 - Porte vitrée

ES **COCINA MIXTA - N. 6 QUEMADORES HORNO MULTIFUNCIONAL - CÁMARA CM. 64X37X35H, TEMP: 50÷250°C, CON 1 PARILLA CM.53X32,5 GN1/1 - PUERTA VIDRIO**

cm. 100 x 60 x 90h

cm. 103 x 67 x 111h / kg 107 / m³ 0,766

27 kW
23.193 kcal/h

€ 5.775,00

3,05 kW
230V~
50/60 Hz

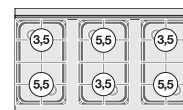

CFM6-610GEM

06691063



CUCINA MISTA 6 FUOCHI CON FORNO ELETTRICO MULTIFUNZIONE - CAMERA CM. 64X37X35H, TEMP: 50÷250°C, CON 1 GRIGLIA CM.53X32,5 GN1/1 - PORTA CIECA INOX

EN Combined range - N. 6 burners Multifunction oven - Chamber cm. 64x37x35h, temp: 50÷250°C, with 1 grid cm.53x32,5 GN1/1 - Stainless steel door

DE Gemischtherd - N. 6 Kochstellen Multifunktions-Ofen cm. 64x37x35h, temp: 50÷250°C, mit 1 Rost cm.53x32,5 GN1/1 - Edelstahltür

FR Cuisinière mixte - N. 6 feux vifs Four à fonctions multiples cm. 64x37x35h, temp: 50÷250°C, avec 1 grille cm.53x32,5 GN1/1 - Porte acier inoxydable

ES **COCINA MIXTA - N. 6 QUEMADORES HORNO MULTIFUNCIONAL - CÁMARA CM. 64X37X35H, TEMP: 50÷250°C, CON 1 PARILLA CM.53X32,5 GN1/1 - PUERTA CIEGA INOX**

cm. 100 x 60 x 90h

cm. 103 x 67 x 111h / kg 107 / m³ 0,766

27 kW
23.193 kcal/h

€ 5.775,00

3,05 kW
230V~
50/60 Hz

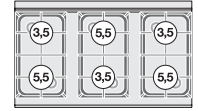
CF2-68GEM

06790861



CUCINA MISTA 2 FUOCHI CON FORNO ELETTRICO STATICO CON GRILL CM. 67X38X34H, TEMP: 50÷250°C, CON 1 GRIGLIA CM.65X36

EN Combined range static oven - N. 2 burners Static oven cm. 67x38x34h, temp: 50÷250°C, with 1 grid cm.65x36

DE Gemischtherd statischer Ofen - N. 2 Kochstellen Statischer Ofen cm. 67x38x34h, temp: 50÷250°C, mit 1 Rost cm.65x36

FR Cuisinière mixte gaz four estatico - N. 2 feux vifs Four statique cm. 67x38x34h, temp: 50÷250°C, avec 1 grille cm.65x36

ES **COCINA MIXTA HORNO ESTÁTICO - N. 2 QUEMADORES HORNO ESTÁTICO CM. 67X38X34H, TEMP: 50÷250°C, CON 1 PARILLA CM.65X36**

cm. 80 x 60 x 90h

cm. 83 x 67 x 111h / kg 95 / m³ 0,617

17 kW
14.620 kcal/h

€ 4.507,00

3,05 kW
230V~
50/60 Hz

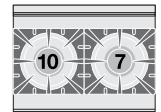
CFM2-68GEM/V

06790862



CUCINA MISTA 2 FUOCHI CON FORNO ELETTRICO MULTIFUNZIONE CM. 64X37X35H, TEMP: 50÷250°C, CON 1 GRIGLIA CM.53X32,5 GN1/1 - PORTA VETRO

EN Combined range - N. 2 burners Multifunction electric oven cm. 64x37x35h, temp: 50÷250°C, with 1 grid cm.53x32,5 GN1/1 - Glass door

DE Gemischtherd - N. 2 Kochstellen Multifunktions-Elektroofen cm. 64x37x35h, temp: 50÷250°C, mit 1 Rost cm.53x32,5 GN1/1 - Glastür

FR Cuisinière mixte - N. 2 feux vifs Four électrique à fonctions multiples cm. 64x37x35h, temp: 50÷250°C, avec 1 grille cm.53x32,5 GN1/1 - Porte acier inoxydable

ES **COCINA MIXTA - N. 2 QUEMADORES HORNO ELÉCTRICO MULTIFUNCIONAL CM. 64X37X35H, TEMP: 50÷250°C, CON 1 PARILLA CM.53X32,5 GN1/1 - PUERTA CIEGA INOX**

cm. 80 x 60 x 90h

cm. 83 x 67 x 111h / kg 96 / m³ 0,617

17 kW
14.620 kcal/h

€ 4.807,00

3,05 kW
230V~
50/60 Hz

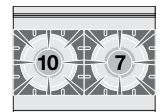
CFM2-68GEM

06790863



CUCINA MISTA 2 FUOCHI CON FORNO ELETTRICO MULTIFUNZIONE CM. 64X37X35H, TEMP: 50÷250°C, CON 1 GRIGLIA CM.53X32,5 GN1/1 - PORTA CIECA INOX

EN Combined range - N. 2 burners Multifunction electric oven cm. 64x37x35h, temp: 50÷250°C, with 1 grid cm.53x32,5 GN1/1 - Stainless steel door

DE Gemischtherd - N. 2 Kochstellen Multifunktions-Elektroofen cm. 64x37x35h, temp: 50÷250°C, mit 1 Rost cm.53x32,5 GN1/1 - Edelstahltür

FR Cuisinière mixte - N. 2 feux vifs Four électrique à fonctions multiples cm. 64x37x35h, temp: 50÷250°C, avec 1 grille cm.53x32,5 GN1/1 - Porte acier inoxydable

ES **COCINA MIXTA - N. 2 QUEMADORES HORNO ELÉCTRICO MULTIFUNCIONAL CM. 64X37X35H, TEMP: 50÷250°C, CON 1 PARILLA CM.53X32,5 GN1/1 - PUERTA CIEGA INOX**

cm. 80 x 60 x 90h

cm. 83 x 67 x 111h / kg 96 / m³ 0,617

17 kW
14.620 kcal/h

€ 4.807,00

3,05 kW
230V~
50/60 Hz

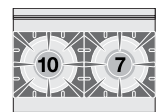
CF3-612GEMV

06791261



CUCINA MISTA 3 FUOCHI CON FORNO ELETTRICO STATICO CON GRILL CM. 67X38X34H, TEMP: 50÷250°C, CON 1 GRIGLIA CM.65X36, VANO NEUTRO CON PORTA

EN Combined range static oven - N. 3 burners Static oven cm. 67x38x34h, temp: 50÷250°C, with 1 grid cm.65x36 - Neutral cabinet with door

DE Gemischtherd statischer Ofen - N. 3 Kochstellen Statischer Ofen cm. 67x38x34h, temp: 50÷250°C, mit 1 Rost cm.65x36 - Neutrales Schrankelement mit Tür

FR Cuisinière mixte gaz four estatico - N. 3 feux vifs Four statique cm. 67x38x34h, temp: 50÷250°C, avec 1 grille cm.65x36 - Element neutre avec porte

ES **COCINA MIXTA HORNO ESTÁTICO - N. 3 QUEMADORES HORNO ESTÁTICO CM. 67X38X34H, TEMP: 50÷250°C, CON 1 PARILLA CM.65X36 - ARMARIO NEUTRO CON PUERTA EQUIPADO**

cm. 120 x 60 x 90h

cm. 123 x 67 x 111h / kg 102 / m³ 0,915

27 kW
23.220 kcal/h

€ 5.522,00

3,05 kW
230V~
50/60 Hz

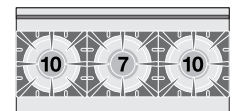

CFM3-612GEMV/V

06791262



CUCINA MISTA 3 FUOCHI CON FORNO ELETTRICO MULTIFUNZIONE CM. 64X37X35H, TEMP: 50÷250°C, CON 1 GRIGLIA CM.53X32,5 GN1/1 - PORTA VETRO - VANO NEUTRO CON PORTA

EN Combined range - N. 3 burners Multifunction electric oven cm. 64x37x35h, temp: 50÷250°C, with 1 grid cm.53x32,5 GN1/1 - Glass door - Neutral cabinet with door
DE Gemischtherd - N. 3 Kochstellen Multifunktions-Elektroofen cm. 64x37x35h, temp: 50÷250°C, mit 1 Rost cm.53x32,5 GN1/1 - Glastür - Neutrales Schrankelement mit Tür

FR Cuisinière mixte - N. 3 feux vifs Four électrique à fonctions multiples cm. 64x37x35h, temp: 50÷250°C, avec 1 grille cm.53x32,5 GN1/1 - Porte acier inoxydable - Element neutre avec porte

ES **COCINA MIXTA - N. 3 QUEMADORES HORNO ELÉCTRICO MULTIFUNCIONAL CM. 64X37X35H, TEMP: 50÷250°C, CON 1 PARILLA CM.53X32,5 GN1/1 - PUERTA CIEGA INOX - ARMARIO NEUTRO CON PUERTA EQUIPADO**

cm. 120 x 60 x 90h

cm. 123 x 67 x 111h / kg 103 / m³ 0,915

27 kW
23.220 kcal/h

€ 5.764,00

3,05 kW
230V~
50/60 Hz

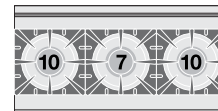
**CFM3-612GEMV**

06791263



CUCINA MISTA 3 FUOCHI CON FORNO ELETTRICO MULTIFUNZIONE CM. 64X37X35H, TEMP: 50÷250°C, CON 1 GRIGLIA CM.53X32,5 GN1/1 - PORTA CIEGA INOX - VANO NEUTRO CON PORTA

EN Combined range - N. 3 burners Multifunction electric oven cm. 64x37x35h, temp: 50÷250°C, with 1 grid cm.53x32,5 GN1/1 - Stainless steel door - Neutral cabinet with door

DE Gemischtherd - N. 3 Kochstellen Multifunktions-Elektroofen cm. 64x37x35h, temp: 50÷250°C, mit 1 Rost cm.53x32,5 GN1/1 - Edelstahltür - Neutrales Schrankelement mit Tür

FR Cuisinière mixte - N. 3 feux vifs Four électrique à fonctions multiples cm. 64x37x35h, temp: 50÷250°C, avec 1 grille cm.53x32,5 GN1/1 - Porte acier inoxydable - Element neutre avec porte

ES **COCINA MIXTA - N. 3 QUEMADORES HORNO ELÉCTRICO MULTIFUNCIONAL CM. 64X37X35H, TEMP: 50÷250°C, CON 1 PARILLA CM.53X32,5 GN1/1 - PUERTA CIEGA INOX - ARMARIO NEUTRO CON PUERTA EQUIPADO**

cm. 120 x 60 x 90h

cm. 123 x 67 x 111h / kg 103 / m³ 0,915

27 kW
23.220 kcal/h

€ 5.764,00

3,05 kW
230V~
50/60 Hz

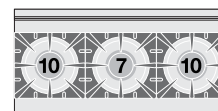
**PIANI COTTURA ELETTRICI - TOP**

EN ELECTRIC BOILING UNIT - TOP **DE** ELEKTRO KOCHPLATTEN- TOP **FR** PLAN DE CUISSON ÉLECTRIQUE - TOP **ES** **SOBRES DE COCCIÓN ELECTRICO - TOP**

PCT-63ET

16030330



PIANO COTTURA TRIFASE N. 2 PIASTRE

EN Boiling unit - N. 2 plates
DE Kochplatte - N. 2 Kochplatten
FR Rechaud - N. 2 plaques
ES **SOBRE DE COCCIÓN - N. 2 PLANCHAS**

cm. 30 x 60 x 28h

cm. 33 x 69 x 65h / kg 16 / m³ 0,148

3 kW
400V~2N
230V~3
230V~
50/60 Hz

€ 954,00**PCT-66ET**

16030630



PIANO COTTURA TRIFASE N. 4 PIASTRE

EN Boiling unit - N. 4 plates
DE Kochplatte - N. 4 Kochplatten
FR Rechaud - N. 4 plaques
ES **SOBRE DE COCCIÓN - N. 4 PLANCHAS**

cm. 60 x 60 x 28h

cm. 63 x 69 x 65h / kg 27 / m³ 0,283

6 kW
400V~3N
230V~3
230V~
50/60 Hz

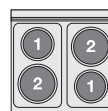
€ 1.506,00

PCCT-63ET

16030332



PIANO COTTURA VETROCERAMICA TRIFASE - N. 2 ZONE - VETRO CM.25X47

- EN** Ceramic glass boiling unit - n. 2 zones - glass cm.25x47
- DE** Ceran-Kochplatte dreiphasig - 2 zonen - Glas 25x47 cm
- FR** Plan de cuisson à vitrocéramique triphasé N. 2 zones - Verre cm.25x47
- ES** **SOBRE DE COCCIÓN TRIFÁSICO VITROCERÁMICA - 2 ZONAS - VIDRIO CM.35X57**

- cm. 30 x 60 x 28h
- cm. 33 x 69 x 65h / kg 19 / m³ 0,148

	3 kW
	400V~2N
	230V~3
	230V~
	50/60 Hz

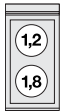
€ 2.125,00

PCCT-66ET

16030632



PIANO COTTURA VETROCERAMICA TRIFASE - N. 4 ZONE - VETRO CM.55X47

- EN** Ceramic glass boiling unit - n. 4 zones - glass cm.55x47
- DE** Ceran-Kochplatte dreiphasig - 4 zonen - Glas 55x47 cm
- FR** Plan de cuisson à vitrocéramique triphasé N. 4 zones - Verre cm.55x47
- ES** **SOBRE DE COCCIÓN TRIFÁSICO VITROCERÁMICA - 2 ZONAS - VIDRIO CM.35X57**

- cm. 60 x 60 x 28h
- cm. 63 x 69 x 65h / kg 26 / m³ 0,283

	6 kW
	400V~3N
	230V~3
	230V~
	50/60 Hz

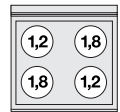
€ 3.559,00

PIANI COTTURA A INDUZIONE - TOP
EN INDUCTION BOILING UNIT - TOP DE INDUKTIONNS-KOCHPLATTEN - TOP FR PLAN DE CUISSON À INDUCTION - TOP ES SOBRES DE COCCIÓN POR INDUCCIÓN - TOP
PCIT-64ET

16030433



PIANI COTTURA A INDUZIONE TRIFASE - VETRO CM 35X47 (NON POSIZIONARE SU FORNI O CASSETTIERE)

- EN** Three-phase induction cooking top - Plates cm 35x47 (do not place on ovens or drawers)
- DE** Induktions-Kochplatte dreiphasig cm 35x47 (nicht Platz auf Öfen oder Schubladen)
- FR** Plan de cuisson à induction triphasé - Verre cm. 35x47 (ne placez pas sur des fours ou des tiroirs)
- ES** **ENCIMERA INDUCCIÓN TRIFÁSICA - VIDRIO CM. 35X47 (NO COLOQUE EN LOS HORNOS O EN LOS CAJONES)**

- cm. 40 x 60 x 28h
- cm. 43 x 69 x 65h / kg 23 / m³ 0,193

	5 kW
	400V~3
	50/60 Hz

€ 5.643,00
PCIWT-64ET

16030434



PIANI COTTURA A INDUZIONE WOK 1 PIASTRA INDUZIONE - VETRO Ø 30 CM (NON POSIZIONARE SU FORNI O CASSETTIERE)

- EN** Three-phase wok induction cooking top 1 glass induction plates Ø 30 cm (do not place on ovens or drawers)
- DE** Induktions-Kochplatte dreiphasig Wok 1 Glasinduktionsplatten Ø 30 cm (nicht Platz auf Öfen oder Schubladen)
- FR** Plan de cuisson à induction triphasé wok 1 plaques à induction - Verre Ø 30 cm (ne placez pas sur des fours ou des tiroirs)
- ES** **ENCIMERA INDUCCIÓN TRIFÁSICA WOK 1 PLACAS INDUCCIÓN - VIDRIO Ø 30 CM (NO COLOQUE EN LOS HORNOS O EN LOS CAJONES)**

- cm. 40 x 60 x 28h
- cm. 43 x 69 x 65h / kg 23 / m³ 0,193

	5 kW
	400V~3
	50/60 Hz

€ 5.566,00

PIANI COTTURA A GAS - TOP

EN GAS BOILING UNIT - TOP DE GAS KOCHPLATTEN - TOP FR PLAN DE CUISSON À GAZ - TOP ES SOBRES DE COCCIÓN DE GAS - TOP

PCT-63G
 16210350

PIANO COTTURA A GAS, 2 FUOCHI

EN Gas heated boiling - 2 burners

DE Gas-Kochplatte - 2 Kochstellen

FR Rechaud gaz - 2 feux vifs

ES SOBRES DE COCCIÓN GAS - 2 QUEMADORES

cm. 30 x 60 x 28h

cm. 33 x 69 x 65h / kg 20 / m³ 0,148
 9 kW
 7.740 kcal/h

€ 1.363,00

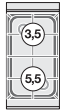
PCT-66G
 16210650

PIANO COTTURA A GAS, 4 FUOCHI

EN Gas heated boiling - 4 burners

DE Gas-Kochplatte - 4 Kochstellen

FR Rechaud gaz - 4 feux vifs

ES SOBRES DE COCCIÓN GAS - 4 QUEMADORES

cm. 60 x 60 x 28h

cm. 63 x 69 x 65h / kg 31 / m³ 0,283
 18 kW
 15.480 kcal/h

€ 2.143,00

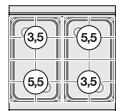
PCT-610G
 16211050

PIANO COTTURA A GAS, 6 FUOCHI

EN Gas heated boiling - 6 burners

DE Gas-Kochplatte - 6 Kochstellen

FR Rechaud gaz - 6 feux vifs

ES SOBRES DE COCCIÓN GAS - 6 QUEMADORES

cm. 100 x 60 x 28h

cm. 103 x 69 x 65h / kg 63 / m³ 0,462
 27 kW
 23.220 kcal/h

€ 3.384,00

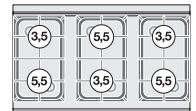
PC1T-64G
 16210451

PIANO COTTURA A GAS, 1 FUOCO

EN Gas heated boiling - 1 burner

DE Gas-Kochplatte - 1 Kochstellen

FR Rechaud gaz - 1 feux vifs

ES SOBRES DE COCCIÓN GAS - 1 QUEMADOR

cm. 40 x 60 x 28h

cm. 43 x 69 x 65h / kg 23 / m³ 0,193
 10 kW
 8.600 kcal/h

€ 1.282,00



PC2T-68G

16210851



PIANO COTTURA A GAS, 2 FUOCHI

- EN** Gas heated boiling - 2 burners
- DE** Gas-Kochplatte - 2 Kochstellen
- FR** Rechaud gaz - 2 feux vifs
- ES** **SOBRES DE COCCIÓN GAS - 2 QUEMADORES**

- cm. 80 x 60 x 28h
- cm. 83 x 69 x 65h / kg 39 / m³ 0,372

 17 kW
14.620 kcal/h

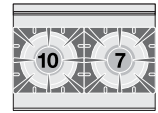
€ 2.003,00

PC3T-612G

16211251



PIANO COTTURA A GAS, 3 FUOCHI

- EN** Gas heated boiling - 3 burners
- DE** Gas-Kochplatte - 3 Kochstellen
- FR** Rechaud gaz - 3 feux vifs
- ES** **SOBRES DE COCCIÓN GAS - 3 QUEMADORES**

- cm. 120 x 60 x 28h
- cm. 123 x 69 x 65h / kg 54 / m³ 0,552

 27 kW
23.220 kcal/h

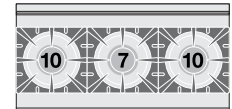
€ 2.932,00

TUTTAPIASTRA A GAS - TOP
EN GAS SOLID TOP - TOP DE GAS KOCHPLATTEN - TOP FR TOUTE PLAQUE A GAZ - TOP ES PLACA DE COCCIÓN DE GAS - TOP
TPT-64G

16290450



TUTTAPIASTRA A GAS PIASTRA CM 37X50

- EN** Solid top - Plate cm 37x50
- DE** Kochplatte - Platte cm 37x50
- FR** Toute plaque - Plaque cm 37x50
- ES** **PLACA RADIANTE - PLACA CM 37X50**

- cm. 40 x 60 x 28h
- cm. 43 x 69 x 65h / kg 54 / m³ 0,193

 5,5 kW
4.730 kcal/h

€ 2.175,00
CUOCIPASTA ELETTRICI - TOP
EN ELECTRIC PASTA COOKERS - TOP DE ELEKTRO NUDELKOCHER - TOP FR CUISEURS DE PÂTES ÉLECTRIQUE - TOP ES CUECEPASTAS ELECTRICAS - TOP
CPT-64ET

16100430



CUOCIPASTA TRIFASE LT. 17 VASCA CM. 31X33,5X22H. RUBINETTO SCARICO (CESTI ESCLUSI)

- EN** Pasta cooker threephase 17 lts. Tank cm. 31x33,5x22h. Drain-tap (BASKETS EXCLUDED)
- DE** Nudelkocher dreiphasig lt.17 Becken cm. 31x33,5x22h. Ablasshahn (KORB AUSGESCHLOSSEN)
- FR** Cuiser à pates triphase lt.17 Cuve cm. 31x33,5x22h. Robinet de vidange (PANIERS EXCLUS)
- ES** **CUECE PASTA TRIFÁSICO LT.17 CUBA CM. 31X33,5X22H. GRIFO DESCARGA (CESTAS EXCLUIDAS)**

- cm. 40 x 60 x 28h
- cm. 43 x 69 x 65h / kg 27 / m³ 0,193

 4,1 kW
400V~3N
50/60 Hz

€ 2.098,00
COMBINAZIONI

- Combinations / • Zusammenstellungen
- Combinaisons / • Combinación múltiple



CPT-66ET
 16100630

CUOCIPASTA TRIFASE LT. 25 VASCA CM. 51X31X22H. RUBINETTO SCARICO (CESTI ESCLUSI)

EN Pasta cooker threephase 25 lts. Tank cm. 51x31x22h. Drain-tap (BASKETS EXCLUDED)

DE Nudelkocher dreiphasig lt.25 Becken cm. 51x31x22h. Ablasshahn (KORB AUSGESCHLOSSEN)

FR Cuiseur à pates triphase lt.25 Cuve cm. 51x31x22h. Robinet de vidange (PANIERS EXCLUS)

ES CUECE PASTA TRIFÁSICO LT.25 CUBA CM. 51X31X22H. GRIFO DESCARGA (CESTAS EXCLUIDAS)

cm. 60 x 60 x 28h

 cm. 63 x 69 x 65h / kg 42 / m³ 0,283

 6,25 kW
 400V~3N
 50/60 Hz

€ 2.331,00
COMBINAZIONI

- Combinations / • Zusammenstellungen
- Combinaisons / • Combinación múltiple

CUOCIPASTA A GAS - TOP

EN GAS PASTA COOKERS - TOP DE GAS NUDELKOCHER - TOP FR CUISEURS DE PÂTES À GAZ - TOP ES CUECEPASTAS A GAS - TOP

CPT-64G
 16270450

CUOCIPASTA A GAS CAPACITA' LT. 13 VASCA CM. 31X33,5X18H. RUBINETTO SCARICO (CESTI ESCLUSI)

EN Gas pasta cookers Tank capacity 13 lts. Tank cm. 31x33,5x18h. Drain-tap (BASKETS EXCLUDED)

DE Gas -Nudelkocher Beckeninhalte lt.13 Becken cm. 31x33,5x18h. Ablasshahn (KORB AUSGESCHLOSSEN)

FR Cuiseur à pates gaz Cuve lt.13 Cuve cm. 31x33,5x18h. Robinet de vidange (PANIERS EXCLUS)

ES CUECE PASTA GAS CUBA 13 LT. CUBA CM. 31X33,5X18H. GRIFO DESCARGA (CESTAS EXCLUIDAS)

cm. 40 x 60 x 28h

 cm. 43 x 69 x 65h / kg 30 / m³ 0,193

 6 kW
 5.160 kcal/h

€ 2.129,00
COMBINAZIONI

- Combinations / • Zusammenstellungen
- Combinaisons / • Combinación múltiple

CPT-66G
 16270650

CUOCIPASTA A GAS CAPACITA' LT. 19 VASCA CM. 51X31X18H. RUBINETTO SCARICO (CESTI ESCLUSI)

EN Gas pasta cookers Tank capacity 19 lts. Tank cm. 51x31x18h. Drain-tap (BASKETS EXCLUDED)

DE Gas -Nudelkocher Beckeninhalte lt. 19 Becken cm. 51x31x18h. Ablasshahn (KORB AUSGESCHLOSSEN)

FR Cuiseur à pates gaz Cuve lt.19 Cuve cm. 51x31x18h. Robinet de vidange (PANIERS EXCLUS)

ES CUECE PASTA GAS CUBA 19 LT. CUBA CM. 51X31X18H. GRIFO DESCARGA (CESTAS EXCLUIDAS)

cm. 60 x 60 x 28h

 cm. 63 x 69 x 65h / kg 45 / m³ 0,283

 9 kW
 7.740 kcal/h

€ 2.508,00
COMBINAZIONI

- Combinations / • Zusammenstellungen
- Combinaisons / • Combinación múltiple



CUOCIPASTA ELETTRICI
EN ELECTRIC PASTA COOKERS DE ELEKTRO NUDELKOCHER FR CUISEURS DE PÂTES ÉLECTRIQUE ES CUECEPASTAS ELECTRICAS
CP-66ET
06100630

CUOCIPASTA TRIFASE LT. 40 VASCA CM. 51X30,7X32,7H. RUBINETTO CARICO ACQUA, SFIORATORE + SCARICO A PAVIMENTO (CESTI ESCLUSI)

- EN** Pasta cooker threephase 40 lts. - Tank cm. 51x30,7x32,7h. Water loading tap + overflow device and floor draining (BASKETS EXCLUDED)
- DE** Nudelkocher dreiphasig lt. 40 - Becken cm. 51x30,7x32,7h. Wasserlauf-Hahn + Überlauf-Vorrichtung und Ablauf am Boden (KORB AUSGESCHLOSSEN)
- FR** Cuiseur a pates triphase lt. 40 - Cuve cm. 51x30,7x32,7h. Robinet d'arrivée d'eau trop plein + système de vidange au sol (PANIERS EXCLUS)
- ES** CUECE PASTA TRIFÁSICO LT. 40 - CUBA CM. 51X30,7X32,7H. GRIFO CARGA AGUA + VERTEDERO + DESCARGA A PAVIMENTO (CESTAS EXCLUIDAS)

- cm. 60 x 60 x 90h
- cm. 63 x 67 x 111h / kg 81 / m³ 0,469

⚡ 13,5 kW	€ 3.944,00
400V~3N	
50/60 Hz	

COMBINAZIONI

- Combinations / • Zusammenstellungen
- Combinaisons / • Combinación múltiple

CUOCIPASTA A GAS
EN GAS PASTA COOKERS DE GAS NUDELKOCHER FR CUISEURS DE PÂTES À GAZ ES CUECEPASTAS A GAS
CP-66G
06270650

CUOCIPASTA GAS LT. 40 VASCA CM. 51X30,7X32,7H. RUBINETTO CARICO ACQUA, SFIORATORE + SCARICO A PAVIMENTO (CESTI ESCLUSI)

- EN** Gas pasta cooker on cabinet Tank capacity 40 lts. cm. 51x30,7x32,7h. Water loading tap + overflow device and floor draining (BASKETS EXCLUDED)
- DE** Gas-Nudelkocher Standgerät - Inhalt lt. 40 cm. 51x30,7x32,7h. Wasserlauf-Hahn + Überlauf-Vorrichtung und Ablauf am Boden (KORB AUSGESCHLOSSEN)
- FR** Cuiseur a pates sur coffre gaz - Cuve lt. 40 cm. 51x30,7x32,7h. Robinet d'arrivée d'eau trop plein + système de vidange au sol (PANIERS EXCLUS)
- ES** CUECE PASTA GAS - CUBA 40 LT. CM. 51X30,7X32,7H. GRIFO CARGA AGUA + VERTEDERO + DESCARGA A PAVIMENTO (CESTAS EXCLUIDAS)

- cm. 60 x 60 x 90h
- cm. 63 x 67 x 111h / kg 84 / m³ 0,469

⚡ 13,95 kW	€ 4.392,00
11.997 kcal/h	

⚡ 0,02 KW
230V~
50/60 Hz

COMBINAZIONI

- Combinations / • Zusammenstellungen
- Combinaisons / • Combinación múltiple

BAGNOMARIA ELETTRICI - TOP
EN ELECTRIC BAIN MARIE - TOP DE ELEKTRO WASSERBÄDER - TOP FR BAIN MARIE ÉLECTRIQUE - TOP ES BAÑO MARÍA ELECTRICO - TOP
BMT-63EM
16050310

BAGNOMARIA ELETTRICO MONOFASE VASCA PER GN 1/2 + GN 1/4 H=15

- EN** Bain marie singlephase Bowl for GN 1/2 + GN 1/4 h=15
- DE** Wasserbäder einphasig Becken GN 1/2 + GN 1/4 h=15
- FR** Bain marie monophasé Cuve GN 1/2 + GN 1/4 h=15
- ES** BAÑO DE MARÍA MONOFÁSICO CUBA PARA GN 1/2 + GN 1/4 H=15

- cm. 30 x 60 x 28h
- cm. 33 x 69 x 65h / kg 17 / m³ 0,148

⚡ 1,55 kW	€ 1.140,00
230V~	
50/60 Hz	

BMT-64EM

16050410



BAGNOMARIA ELETTRICO MONOFASE VASCA PER GN 1/2 + GN 1/3 H=15

EN Bain marie singlephase Bowl for GN 1/2 + GN 1/3 h=15**DE** Wasserbäder einphasig Becken GN 1/2 + GN 1/3 h=15**FR** Bain marie monophasé Cuve GN 1/2 + GN 1/3 h=15**ES** BAÑO DE MARÍA MONOFÁSICO CUBA PARA GN 1/2 + GN 1/3 H=15

cm. 40 x 60 x 28h

cm. 43 x 69 x 65h / kg 21 / m³ 0,193
 1,65 kW
 230V~
 50/60 Hz
€ 1.329,00**BMT-66EM**

16050610



BAGNOMARIA ELETTRICO MONOFASE VASCA PER GN 1/1 + 2 GN 1/4 H=15

EN Bain marie singlephase Bowl for GN 1/1 + 2 GN 1/4 h=15**DE** Wasserbäder einphasig Becken GN 1/1 + 2 GN 1/4 h=15**FR** Bain marie monophasé Cuve GN 1/1 + 2 GN 1/4 h=15**ES** BAÑO DE MARÍA MONOFÁSICO CUBA PARA GN 1/1 + 2 GN 1/4 H=15

cm. 60 x 60 x 28h

cm. 63 x 69 x 65h / kg 23 / m³ 0,283
 3,1 kW
 230V~
 50/60 Hz
€ 1.472,00**BAGNOMARIA A GAS - TOP****EN** GAS BAIN MARIE - TOP **DE** GAS WASSERBÄDER - TOP **FR** BAIN MARIE A GAZ - TOP **ES** BAÑO MARÍA DE GAS - TOP**BMT-64G**

16220450



BAGNOMARIA A GAS VASCA PER GN 1/2 + GN 1/3 H=15

EN Gas bain-marie Bowl for GN 1/2 + GN 1/3 h=15**DE** Gas Wasserbad Becken GN 1/2 + GN 1/3 h=15**FR** Bain-marie gaz Cuve pour GN 1/2 + GN 1/3 h=15**ES** BAÑO DE MARÍA GAS CUBA PARA GN 1/2 + GN 1/3 H=15

cm. 40 x 60 x 28h

cm. 43 x 69 x 65h / kg 26 / m³ 0,193
 2,5 kW
 2.150 kcal/h
€ 1.676,00**BMT-66G**

16220650



BAGNOMARIA A GAS VASCA PER GN 1/1 + 2 GN 1/4 H=15

EN Gas bain-marie Bowl for GN 1/1 + 2 GN 1/4 h=15**DE** Gas Wasserbad Becken GN 1/1 + 2 GN 1/4 h=15**FR** Bain-marie gaz Cuve pour GN 1/1 + 2 GN 1/4 h=15**ES** BAÑO DE MARÍA GAS CUBA PARA GN 1/1 + 2 GN 1/4 H=15

cm. 60 x 60 x 28h

cm. 63 x 69 x 65h / kg 28 / m³ 0,283
 4,5 kW
 3.870 kcal/h
€ 2.029,00

CONTENITORE CALDO INFRAROSSO - TOP

EN ELECTRIC CHIP DUMP WITH INFRARED HEATER - TOP
 DE FRITTENWANNE MIT INFRAROT - TOP
 FR SILO A FRITES AVEC INFRAROUGE - TOP
 ES **CONTENEDOR CALIENTE POR INFRARROJO - TOP**

BST-64EM
 16040410



CONTENITORE CALDO MONOFASE VASCA GN 2/3 H15 CON FALSO FONDO FORATO
EN Fry dump singlephase Bowl GN 2/3 h15 with perforated bottom
DE Frittenwanne einphasig Becke GN 2/3 h15 mit gelochtem Bodenrost
FR Silo à frites monophasé Cuve GN 2/3 h15 avec double-fond perforé
ES **RECIPIENTE CALIENTE MONOFÁSICO CUBA GN 2/3 H15 CON FALSO FONDO AGUJERADO**

cm. 40 x 60 x 28h
 cm. 43 x 69 x 65h / kg 22 / m³ 0,193

1,47 kW **€ 1.434,00**
 230V~
 50/60 Hz

FRY-TOP ELETTRICI - TOP

EN ELECTRIC GRIDDLE - TOP
 DE ELEKTROGRIDDLEPLATTEN - TOP
 FR FRY-TOP ÉLECTRIQUE - TOP
 ES **FRY-TOP ELECTRICO - TOP**

FTLT-64ET
 16060431



FRY-TOP ELETTRICO LISCIO, PIASTRA CM.39,5X45
EN Electric Fry-top smooth griddle, plate cm.39,5x45
DE Griddleplatte elektrische glatt, platte cm.39,5x45
FR Plaque électriques lisse, plaque cm.39,5x45
ES **FRY-TOP ELÉCTRICO LISO, PLANCHA CM.39,5X45**

cm. 40 x 60 x 28h
 cm. 43 x 69 x 65h / kg 49 / m³ 0,193

4,5 kW **€ 1.488,00**
 400V~3N
 230V~3
 50/60 Hz

FTLT-64ETS
 16060434

FRY-TOP ELETTRICO LISCIO CROMATO SUPERCHROME (MOCA APPROVED), PIASTRA CM.39,5X45
EN Electric Fry-top smooth chromed griddle SUPERCHROME (Moca Approved), plate cm.39,5x45
DE Griddleplatte elektrische glatt hartverchromt SUPERCHROME (Moca Approved), platte cm.39,5x45
FR Plaque électriques lisse chromée SUPERCHROME (Moca Approved), plaque cm.39,5x45
ES **FRY-TOP ELÉCTRICO LISO CROMADO SUPERCHROME (MOCA APPROVED), PLANCHA CM.39,5X45**

cm. 40 x 60 x 28h
 cm. 43 x 69 x 65h / kg 49 / m³ 0,193

4,5 kW **€ 2.042,00**
 400V~3N
 230V~3
 50/60 Hz

FTLT-64ETSS
 16060430

FRY-TOP ELETTRICO LISCIO CROMO LUCIDO, PIASTRA CM.39,5X45
EN Electric Fry-top smooth POLISHED CHROME, plate cm.39,5x45
DE Griddleplatte elektrische glatt POLIERTEM CHROM, platte cm.39,5x45
FR Plaque électriques lisse CHROME POLI, plaque cm.39,5x45
ES **FRY-TOP ELÉCTRICO LISO CROMO PULIDO, PLANCHA CM.39,5X45**

cm. 40 x 60 x 28h
 cm. 43 x 69 x 65h / kg 49 / m³ 0,193

4,5 kW **€ 2.042,00**
 400V~3N
 230V~3
 50/60 Hz

FTRT-64ET

16060433



FRY-TOP ELETTRICO RIGATO, PIASTRA CM.39,5X45

EN Electric Fry-top grooved griddle, plate cm.39,5x45**DE** Griddleplatte elektrische gerillt, platte cm.39,5x45**FR** Plaque électriques nervurée, plaque cm.39,5x45**ES** **FRY-TOP ELÉCTRICO ESTRIADO, PLANCHA CM.39,5X45**

cm. 40 x 60 x 28h

 cm. 43 x 69 x 65h / kg 49 / m³ 0,193

⚡ 4,5 kW
400V~3N
230V~3
50/60 Hz

€ 1.709,00

**FTRT-64ETS**

16060436

FRY-TOP ELETTRICO RIGATO CROMATO SUPERCHROME (MOCA APPROVED), PIASTRA CM.39,5X45

EN Electric Fry-top grooved chromed griddle SUPERCHROME (Moca Approved), plate cm.39,5x45**DE** Griddleplatte elektrische gerillt hartverchromt SUPERCHROME (Moca Approved), platte cm.39,5x45**FR** Plaque électriques nervurée chromée SUPERCHROME (Moca Approved), plaque cm.39,5x45**ES** **FRY-TOP ELÉCTRICO ESTRIADO CROMADO SUPERCHROME (MOCA APPROVED), PLANCHA CM.39,5X45**

cm. 40 x 60 x 28h

 cm. 43 x 69 x 65h / kg 49 / m³ 0,193

⚡ 4,5 kW
400V~3N
230V~3
50/60 Hz

€ 2.239,00

**FTLT-66ET**

16060631



FRY-TOP ELETTRICO LISCIO, PIASTRA CM.59,5X45 - 2 ZONE DI COTTURA

EN Electric Fry-top smooth griddle, plate cm.59,5x45 - 2 cooking areas**DE** Griddleplatte elektrische glatt, platte cm.59,5x45 - 2 Heizzonen**FR** Plaque électriques lisse, plaque cm.59,5x45 - 2 zones de cuisson**ES** **FRY-TOP ELÉCTRICO LISO, PLANCHA CM.59,5X45 - 2 ZONAS DE COCCIÓN**

cm. 60 x 60 x 28h

 cm. 63 x 69 x 65h / kg 66 / m³ 0,283

⚡ 6,75 kW
400V~3N
230V~3
50/60 Hz

€ 1.953,00

**FTLT-66ETS**

16060634

FRY-TOP ELETTRICO LISCIO CROMATO SUPERCHROME (MOCA APPROVED), PIASTRA CM.59,5X45 - 2 ZONE DI COTTURA

EN Electric Fry-top smooth chromed griddle SUPERCHROME (Moca Approved), plate cm.59,5x45 - 2 cooking areas**DE** Griddleplatte elektrische glatt hartverchromt SUPERCHROME (Moca Approved), platte cm.59,5x45 - 2 Heizzonen**FR** Plaque électriques lisse chromée SUPERCHROME (Moca Approved), plaque cm.59,5x45 - 2 zones de cuisson**ES** **FRY-TOP ELÉCTRICO LISO CROMADO SUPERCHROME (MOCA APPROVED), PLANCHA CM.59,5X45 - 2 ZONAS DE COCCIÓN**

cm. 60 x 60 x 28h

 cm. 63 x 69 x 65h / kg 66 / m³ 0,283

⚡ 6,75 kW
400V~3N
230V~3
50/60 Hz

€ 2.643,00

**FTLT-66ETSS**

16060630

FRY-TOP ELETTRICO LISCIO CROMO LUCIDO, PIASTRA CM.59,5X45 - 2 ZONE DI COTTURA

EN Electric Fry-top smooth POLISHED CHROME, plate cm.59,5x45 - 2 cooking areas**DE** Griddleplatte elektrische glatt POLIERTEM CHROM, platte cm.59,5x45 - 2 Heizzonen**FR** Plaque électriques lisse CHROME POLI, plaque cm.59,5x45 - 2 zones de cuisson**ES** **FRY-TOP ELÉCTRICO LISO CROMO PULIDO, PLANCHA CM.59,5X45 - 2 ZONAS DE COCCIÓN**

cm. 60 x 60 x 28h

 cm. 63 x 69 x 65h / kg 66 / m³ 0,283

⚡ 6,75 kW
400V~3N
230V~3
50/60 Hz

€ 2.643,00



FTLRT-66ET

16060632



FRY-TOP ELETTRICO 1/2 RIGATO + 1/2 LISCIO, PIASTRA CM.59,5X45 - 2 ZONE DI COTTURA

- EN** Electric Fry-top 1/2 grooved + 1/2 smooth, plate cm.59,5x45 - 2 cooking areas
- DE** Griddleplatte elektrische 1/2 gerillt + 1/2 glatt, platte cm.59,5x45 - 2 Heizzonen
- FR** Plaque électriques 1/2 nervurée + 1/2 lisse, plaque cm.59,5x45 - 2 zones de cuisson
- ES** **FRY-TOP ELÉCTRICO 1/2 ESTRIADO + 1/2 LISO, PLANCHA CM.59,5X45 - 2 ZONAS DE COCCIÓN**

cm. 60 x 60 x 28h

 cm. 63 x 69 x 65h / kg 66 / m³ 0,283

⚡ 6,75 kW	€ 2.127,00
400V~3N	
230V~3	
50/60 Hz	

€ 2.127,00

FTLRT-66ETS

16060635

FRY-TOP ELETTRICO 1/2 RIGATO + 1/2 LISCIO CROMATO SUPERCHROME (MOCA APPROVED), PIASTRA CM.59,5X45 - 2 ZONE DI COTTURA

- EN** Electric Fry-top 1/2 grooved + 1/2 smooth chromed griddle SUPERCHROME (Moca Approved), plate cm.59,5x45 - 2 cooking areas
- DE** Griddleplatte elektrische 1/2 gerillt + 1/2 glatt hartverchromt SUPERCHROME (Moca Approved), platte cm.59,5x45 - 2 Heizzonen
- FR** Plaque électriques 1/2 nervurée + 1/2 lisse chromée SUPERCHROME (Moca Approved), plaque cm.59,5x45 - 2 zones de cuisson
- ES** **FRY-TOP ELÉCTRICO 1/2 ESTRIADO + 1/2 LISO CROMADO SUPERCHROME (MOCA APPROVED), PLANCHA CM.59,5X45 - 2 ZONAS DE COCCIÓN**

cm. 60 x 60 x 28h

 cm. 63 x 69 x 65h / kg 66 / m³ 0,283

⚡ 6,75 kW	€ 2.825,00
400V~3N	
230V~3	
50/60 Hz	

€ 2.825,00

FTRT-66ET

16060633



FRY-TOP ELETTRICO RIGATO, PIASTRA CM.59,5X45 - 2 ZONE DI COTTURA

- EN** Electric Fry-top grooved griddle, plate cm.59,5x45 - 2 cooking areas
- DE** Griddleplatte elektrische gerillt, platte cm.59,5x45 - 2 Heizzonen
- FR** Plaque électriques nervurée, plaque cm.59,5x45 - 2 zones de cuisson
- ES** **FRY-TOP ELÉCTRICO ESTRIADO, PLANCHA CM.59,5X45 - 2 ZONAS DE COCCIÓN**

cm. 60 x 60 x 28h

 cm. 63 x 69 x 65h / kg 66 / m³ 0,283

⚡ 6,75 kW	€ 2.325,00
400V~3N	
230V~3	
50/60 Hz	

€ 2.325,00

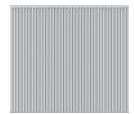
FTRT-66ETS

16060636

FRY-TOP ELETTRICO RIGATO CROMATO SUPERCHROME (MOCA APPROVED), PIASTRA CM.59,5X45 - 2 ZONE DI COTTURA

- EN** Electric Fry-top grooved chromed griddle SUPERCHROME (Moca Approved), plate cm.59,5x45 - 2 cooking areas
- DE** Griddleplatte elektrische gerillt hartverchromt SUPERCHROME (Moca Approved), platte cm.59,5x45 - 2 Heizzonen
- FR** Plaque électriques nervurée chromée SUPERCHROME (Moca Approved), plaque cm.59,5x45 - 2 zones de cuisson
- ES** **FRY-TOP ELÉCTRICO ESTRIADO CROMADO SUPERCHROME (MOCA APPROVED), PLANCHA CM.59,5X45 - 2 ZONAS DE COCCIÓN**

cm. 60 x 60 x 28h

 cm. 63 x 69 x 65h / kg 66 / m³ 0,283

⚡ 6,75 kW	€ 3.015,00
400V~3N	
230V~3	
50/60 Hz	

€ 3.015,00

FTLT-68ET

16060831



FRY-TOP ELETTRICO LISCIO, PIASTRA CM.79,5X45 - 2 ZONE DI COTTURA

- EN** Electric Fry-top smooth griddle, plate cm.79,5x45 - 2 cooking areas
- DE** Griddleplatte elektrische glatt, platte cm.79,5x45 - 2 Heizzonen
- FR** Plaque électriques lisse, plaque cm.79,5x45 - 2 zones de cuisson
- ES** **FRY-TOP ELÉCTRICO LISO, PLANCHA CM.79,5X45 - 2 ZONAS DE COCCIÓN**

cm. 80 x 60 x 28h

 cm. 83 x 69 x 65h / kg 81 / m³ 0,372

⚡ 9 kW	€ 2.822,00
400V~3N	
230V~3	
50/60 Hz	

€ 2.822,00



FTLT-68ETS

16060834

FRY-TOP ELETTRICO LISCIO CROMATO SUPERCHROME (MOCA APPROVED), PIASTRA CM.79,5X45 - 2 ZONE DI COTTURA

EN Electric Fry-top smooth chromed griddle SUPERCHROME (Moca Approved), plate cm.79,5x45 - 2 cooking areas

DE Griddleplatte elektrische glatt hartverchromt SUPERCHROME (Moca Approved), platte cm.79,5x45 - 2 Heizzonen

FR Plaque électriques lisse chromée SUPERCHROME (Moca Approved), plaque cm.79,5x45 - 2 zones de cuisson

ES **FRY-TOP ELÉCTRICO LISO CROMADO SUPERCHROME (MOCA APPROVED), PLANCHA CM.79,5X45 - 2 ZONAS DE COCCIÓN**

cm. 80 x 60 x 28h

cm. 83 x 69 x 65h / kg 81 / m³ 0,372

9 kW **€ 3.460,00**

400V~3N

230V~3

50/60 Hz

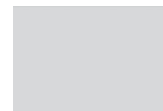
**FTLT-68ETSS**

16060830

FRY-TOP ELETTRICO LISCIO CROMO LUCIDO, PIASTRA CM.79,5X45 - 2 ZONE DI COTTURA

EN Electric Fry-top smooth POLISHED CHROME, plate cm.79,5x45 - 2 cooking areas

DE Griddleplatte elektrische glatt POLIERTEM CHROM, platte cm.79,5x45 - 2 Heizzonen

FR Plaque électriques lisse CHROME POLI, plaque cm.79,5x45 - 2 zones de cuisson

ES **FRY-TOP ELÉCTRICO LISO CROMO PULIDO, PLANCHA CM.79,5X45 - 2 ZONAS DE COCCIÓN**

cm. 80 x 60 x 28h

cm. 83 x 69 x 65h / kg 81 / m³ 0,372

9 kW **€ 3.460,00**

400V~3N

230V~3

50/60 Hz

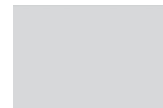
**FTLRT-68ET**

16060832

FRY-TOP ELETTRICO 1/2 RIGATO + 1/2 LISCIO, PIASTRA CM.79,5X45 - 2 ZONE DI COTTURA

EN Electric Fry-top 1/2 grooved + 1/2 smooth, plate cm.79,5x45 - 2 cooking areas

DE Griddleplatte elektrische 1/2 gerillt + 1/2 glatt, platte cm.79,5x45 - 2 Heizzonen

FR Plaque électriques 1/2 nervurée + 1/2 lisse, plaque cm.79,5x45 - 2 zones de cuisson

ES **FRY-TOP ELÉCTRICO 1/2 ESTRIADO + 1/2 LISO, PLANCHA CM.79,5X45 - 2 ZONAS DE COCCIÓN**

cm. 80 x 60 x 28h

cm. 83 x 69 x 65h / kg 81 / m³ 0,372

9 kW **€ 3.002,00**

400V~3N

230V~3

50/60 Hz

**FTLRT-68ETS**

16060835

FRY-TOP ELETTRICO 1/2 RIGATO + 1/2 LISCIO CROMATO SUPERCHROME (MOCA APPROVED), PIASTRA CM.79,5X45 - 2 ZONE DI COTTURA

EN Electric Fry-top 1/2 grooved + 1/2 smooth chromed griddle SUPERCHROME (Moca Approved), plate cm.79,5x45 - 2 cooking areas

DE Griddleplatte elektrische 1/2 gerillt + 1/2 glatt hartverchromt SUPERCHROME (Moca Approved), platte cm.79,5x45 - 2 Heizzonen

FR Plaque électriques 1/2 nervurée + 1/2 lisse chromée SUPERCHROME (Moca Approved), plaque cm.79,5x45 - 2 zones de cuisson

ES **FRY-TOP ELÉCTRICO 1/2 ESTRIADO + 1/2 LISO CROMADO SUPERCHROME (MOCA APPROVED), PLANCHA CM.79,5X45 - 2 ZONAS DE COCCIÓN**

cm. 80 x 60 x 28h

cm. 83 x 69 x 65h / kg 81 / m³ 0,372

9 kW **€ 3.641,00**

400V~3N

230V~3

50/60 Hz

**FTRT-68ET**

16060833

FRY-TOP ELETTRICO RIGATO, PIASTRA CM.79,5X45 - 2 ZONE DI COTTURA

EN Electric Fry-top grooved griddle, plate cm.79,5x45 - 2 cooking areas

DE Griddleplatte elektrische gerillt, platte cm.79,5x45 - 2 Heizzonen

FR Plaque électriques nervurée, plaque cm.79,5x45 - 2 zones de cuisson

ES **FRY-TOP ELÉCTRICO ESTRIADO, PLANCHA CM.79,5X45 - 2 ZONAS DE COCCIÓN**

cm. 80 x 60 x 28h

cm. 83 x 69 x 65h / kg 81 / m³ 0,372

9 kW **€ 3.180,00**

400V~3N

230V~3

50/60 Hz

**FTRT-68ETS**

16060836

FRY-TOP ELETTRICO RIGATO CROMATO SUPERCHROME (MOCA APPROVED), PIASTRA CM.79,5X45 - 2 ZONE DI COTTURA

EN Electric Fry-top grooved chromed griddle SUPERCHROME (Moca Approved), plate cm.79,5x45 - 2 cooking areas

DE Griddleplatte elektrische gerillt hartverchromt SUPERCHROME (Moca Approved), platte cm.79,5x45 - 2 Heizzonen

FR Plaque électriques nervurée chromée SUPERCHROME (Moca Approved), plaque cm.79,5x45 - 2 zones de cuisson

ES **FRY-TOP ELÉCTRICO ESTRIADO CROMADO SUPERCHROME (MOCA APPROVED), PLANCHA CM.79,5X45 - 2 ZONAS DE COCCIÓN**

cm. 80 x 60 x 28h

cm. 83 x 69 x 65h / kg 81 / m³ 0,372

9 kW **€ 3.823,00**

400V~3N

230V~3

50/60 Hz



FTLT-610ET

16061031



FRY-TOP ELETTRICO LISCIO, PIASTRA CM.99,5X45 - 2 ZONE DI COTTURA

EN Electric Fry-top smooth griddle, plate cm.99,5x45 - 2 cooking areas

DE Griddleplatte elektrische glatt, platte cm.99,5x45 - 2 Heizzonen

FR Plaque électriques lisse, plaque cm.99,5x45 - 2 zones de cuisson

ES **FRY-TOP ELÉCTRICO LISO, PLANCHA CM.99,5X45 - 2 ZONAS DE COCCIÓN**

cm. 100 x 60 x 28h

 cm. 103 x 69 x 65h / kg 88 / m³ 0,462

 11,25 kW
 400V~3N
 50/60 Hz

€ 3.212,00

FTLT-610ETS

16061034

FRY-TOP ELETTRICO LISCIO CROMATO SUPERCHROME (MOCA APPROVED), PIASTRA CM.99,5X45 - 2 ZONE DI COTTURA

EN Electric Fry-top smooth chromed griddle SUPERCHROME (Moca Approved), plate cm.99,5x45 - 2 cooking areas

DE Griddleplatte elektrische glatt hartverchromt SUPERCHROME (Moca Approved), platte cm.99,5x45 - 2 Heizzonen

FR Plaque électriques lisse chromée SUPERCHROME (Moca Approved), plaque cm.99,5x45 - 2 zones de cuisson

ES **FRY-TOP ELÉCTRICO LISO CROMADO SUPERCHROME (MOCA APPROVED), PLANCHA CM.99,5X45 - 2 ZONAS DE COCCIÓN**

cm. 100 x 60 x 28h

 cm. 103 x 69 x 65h / kg 88 / m³ 0,462

 11,25 kW
 400V~3N
 50/60 Hz

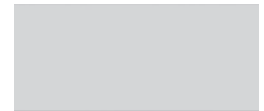
€ 3.824,00

FTLT-610ETSS

16061030

FRY-TOP ELETTRICO LISCIO CROMO LUCIDO, PIASTRA CM.99,5X45 - 2 ZONE DI COTTURA

EN Electric Fry-top smooth POLISHED CHROME, plate cm.99,5x45 - 2 cooking areas

DE Griddleplatte elektrische glatt POLIERTEM CHROM, platte cm.99,5x45 - 2 Heizzonen

FR Plaque électriques lisse CHROME POLI, plaque cm.99,5x45 - 2 zones de cuisson

ES **FRY-TOP ELÉCTRICO LISO CROMO PULIDO, PLANCHA CM.99,5X45 - 2 ZONAS DE COCCIÓN**

cm. 100 x 60 x 28h

 cm. 103 x 69 x 65h / kg 88 / m³ 0,462

 11,25 kW
 400V~3N
 50/60 Hz

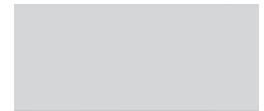
€ 3.824,00

FTLRT-610ET

16061032



FRY-TOP ELETTRICO 2/5 RIGATO + 3/5 LISCIO, PIASTRA CM.99,5X45 - 2 ZONE DI COTTURA

EN Electric Fry-top 2/5 grooved + 3/5 smooth, plate cm.99,5x45 - 2 cooking areas

DE Griddleplatte elektrische 2/5 gerillt + 3/5 glatt, platte cm.99,5x45 - 2 Heizzonen

FR Plaque électriques 2/5 nervurée + 3/5 lisse, plaque cm.99,5x45 - 2 zones de cuisson

ES **FRY-TOP ELÉCTRICO 2/5 ESTRIADO + 3/5 LISO, PLANCHA CM.99,5X45 - 2 ZONAS DE COCCIÓN**

cm. 100 x 60 x 28h

 cm. 103 x 69 x 65h / kg 88 / m³ 0,462

 11,25 kW
 400V~3N
 50/60 Hz

€ 3.406,00

FTLRT-610ETS

16061035

FRY-TOP ELETTRICO 2/5 RIGATO + 3/5 LISCIO CROMATO SUPERCHROME (MOCA APPROVED), PIASTRA CM.99,5X45 - 2 ZONE DI COTTURA

EN Electric Fry-top 2/5 grooved + 3/5 smooth chromed griddle SUPERCHROME (Moca Approved), plate cm.99,5x45 - 2 cooking areas

DE Griddleplatte elektrische 2/5 gerillt + 3/5 glatt hartverchromt SUPERCHROME (Moca Approved), platte cm.99,5x45 - 2 Heizzonen

FR Plaque électriques 2/5 nervurée + 3/5 lisse chromée SUPERCHROME (Moca Approved), plaque cm.99,5x45 - 2 zones de cuisson

ES **FRY-TOP ELÉCTRICO 2/5 ESTRIADO + 3/5 LISO CROMADO SUPERCHROME (MOCA APPROVED), PLANCHA CM.99,5X45 - 2 ZONAS DE COCCIÓN**

cm. 100 x 60 x 28h

 cm. 103 x 69 x 65h / kg 88 / m³ 0,462

 11,25 kW
 400V~3N
 50/60 Hz

€ 4.005,00

PIASTRA PER SANDWICH SOPRA FRYTOP

EN SANDWICHES PLATE ABOVE GRIDLDE DE SANDWICHES PLATTE ÜBER GRIDDLE FR PLAQUE POUR SANDWICHES AU-DESSUS FRY-TOP
 ES **PLANCIA PARA SÁNDWICHES SOBRE FRY-TOP**

RSFT-63EM

16630317



PIASTRA PER SANDWICH SOPRA FRYTOP ELETTRICI - PIASTRA CM. 29X40 (ATTENZIONE: PROFONDITA' MACCHINA +CM.10)

EN Sandwiches plate above electric gridlde - plate cm. 29x40 (ATTENTION: DEPTH MACHINE +cm.10)

DE Sandwiches Platte über Elektrische Griddle - platte cm. 29x40 (VORSICHT: TIEFE MACHINE +cm.10)

FR Plaque pour sandwichs au-dessus électrique fry-top - plaque cm. 29x40 (ATTENTION: PROFONDEUR MACHINE +cm.10)

ES **PLANCIA PARA SÁNDWICHES SOBRE FRY-TOP ELÉCTRICO - PLANCIA CM. 29X40 (ATENCIÓN: PROFUNDIDAD MÁQUINA +CM.10)**

cm. 32 x 61 x 41h

cm. 43 x 77 x 63h / kg 20 / m³ 0,209

2,9 KW
230V~
50/60 Hz

€ 1.536,00

FRY-TOP A GAS - TOP

EN GAS GRIDDLE - TOP DE GASGRIDDLEPLATTEN - TOP FR FRY-TOP À GAZ - TOP ES **FRY-TOP A GAS - TOP**

FTLT-64G

16230451



FRY-TOP GAS LISCIO, PIASTRA CM.39,5X45

EN Gas Fry-top smooth griddle, plate cm.39,5x45

DE Gas-griddleplatte glatt, platte cm.39,5x45

FR Plaque gaz lisse, plaque cm.39,5x45

ES **FRY-TOP GAS LISO, PLANCHA CM.39,5X45**

cm. 40 x 60 x 28h

cm. 43 x 69 x 65h / kg 47 / m³ 0,193

6 kW
5.160 kcal/h

€ 1.570,00

FTLT-64GS

16230454

FRY-TOP GAS LISCIO CROMATO SUPERCHROME (MOCA APPROVED), PIASTRA CM.39,5X45

EN Gas Fry-top smooth chromed griddle SUPERCHROME (Moca Approved), plate cm.39,5x45

DE Gas-griddleplatte glatt hartverchromt SUPERCHROME (Moca Approved), platte cm.39,5x45

FR Plaque gaz lisse chromée SUPERCHROME (Moca Approved), plaque cm.39,5x45

ES **FRY-TOP GAS LISO CROMADO SUPERCHROME (MOCA APPROVED), PLANCHA CM.39,5X45**

cm. 40 x 60 x 28h

cm. 43 x 69 x 65h / kg 47 / m³ 0,193

6 kW
5.160 kcal/h

€ 2.085,00

FTLT-64GSS

16230450

FRY-TOP GAS LISCIO CROMO LUCIDO, PIASTRA CM.39,5X45

EN Gas Fry-top smooth POLISHED CHROME, plate cm.39,5x45

DE Gas-griddleplatte glatt POLIERTEM CHROM, platte cm.39,5x45

FR Plaque gaz lisse CHROME POLI, plaque cm.39,5x45

ES **FRY-TOP GAS LISO CROMO PULIDO, PLANCHA CM.39,5X45**

cm. 40 x 60 x 28h

cm. 43 x 69 x 65h / kg 47 / m³ 0,193

6 kW
5.160 kcal/h

€ 2.085,00

FTRT-64G

16230453



FRY-TOP GAS RIGATO, PIASTRA CM.39,5X45

EN Gas Fry-top grooved griddle, plate cm.39,5x45

DE Gas-griddleplatte gerillt, platte cm.39,5x45

FR Plaque gaz nervurée, plaque cm.39,5x45

ES **FRY-TOP GAS ESTRIADO, PLANCHA CM.39,5X45**

cm. 40 x 60 x 28h

cm. 43 x 69 x 65h / kg 47 / m³ 0,193

6 kW
5.160 kcal/h

€ 1.717,00

FTRT-64GS

16230456

FRY-TOP GAS RIGATO CROMATO SUPERCHROME (MOCA APPROVED), PIASTRA CM.39,5X45

EN Gas Fry-top grooved chromed griddle SUPERCHROME (Moca Approved), plate cm.39,5x45

DE Gas-griddleplatte gerillt hartverchromt SUPERCHROME (Moca Approved), platte cm.39,5x45

FR Plaque gaz nervurée chromée SUPERCHROME (Moca Approved), plaque cm.39,5x45

ES **FRY-TOP GAS ESTRIADO CROMADO SUPERCHROME (MOCA APPROVED), PLANCHA CM.39,5X45**

cm. 40 x 60 x 28h

cm. 43 x 69 x 65h / kg 47 / m³ 0,193

6 kW
5.160 kcal/h

€ 2.299,00

FTLT-66G

16230651



FRY-TOP GAS LISCIO, PIASTRA CM.59,5X45 - 2 ZONE DI COTTURA

EN Gas Fry-top smooth griddle, plate cm.59,5x45 - 2 cooking areas

DE Gas-griddleplatte glatt, platte cm.59,5x45 - 2 Heizzonen

FR Plaque gaz lisse, plaque cm.59,5x45 - 2 zones de cuisson

ES **FRY-TOP GAS LISO, PLANCHA CM.59,5X45 - 2 ZONAS DE COCCIÓN**

cm. 60 x 60 x 28h

 cm. 63 x 69 x 65h / kg 65 / m³ 0,283

 9 kW
7.740 kcal/h

€ 2.238,00

FTLT-66GS

16230654

FRY-TOP GAS LISCIO CROMATO SUPERCHROME (MOCA APPROVED), PIASTRA CM.59,5X45 - 2 ZONE DI COTTURA

EN Gas Fry-top smooth chromed griddle SUPERCHROME (Moca Approved), plate cm.59,5x45 - 2 cooking areas

DE Gas-griddleplatte glatt hartverchromt SUPERCHROME (Moca Approved), platte cm.59,5x45 - 2 Heizzonen

FR Plaque gaz lisse chromée SUPERCHROME (Moca Approved), plaque cm.59,5x45 - 2 zones de cuisson

ES **FRY-TOP GAS LISO CROMADO SUPERCHROME (MOCA APPROVED), PLANCHA CM.59,5X45 - 2 ZONAS DE COCCIÓN**

cm. 60 x 60 x 28h

 cm. 63 x 69 x 65h / kg 65 / m³ 0,283

 9 kW
7.740 kcal/h

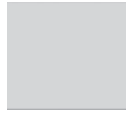
€ 2.694,00

FTLT-66GSS

16230650

FRY-TOP GAS LISCIO CROMO LUCIDO, PIASTRA CM.59,5X45 - 2 ZONE DI COTTURA

EN Gas Fry-top smooth POLISHED CHROME, plate cm.59,5x45 - 2 cooking areas

DE Gas-griddleplatte glatt POLIERTEM CHROM, platte cm.59,5x45 - 2 Heizzonen

FR Plaque gaz lisse CHROME POLI, plaque cm.59,5x45 - 2 zones de cuisson

ES **FRY-TOP GAS LISO CROMO PULIDO, PLANCHA CM.59,5X45 - 2 ZONAS DE COCCIÓN**

cm. 60 x 60 x 28h

 cm. 63 x 69 x 65h / kg 65 / m³ 0,283

 9 kW
7.740 kcal/h

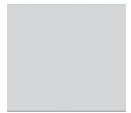
€ 2.694,00

FTLRT-66G

16230652



FRY-TOP GAS 1/2 RIGATO + 1/2 LISCIO, PIASTRA CM.59,5X45 - 2 ZONE DI COTTURA

EN Gas Fry-top 1/2 grooved + 1/2 smooth, plate cm.59,5x45 - 2 cooking areas

DE Gas-griddleplatte 1/2 gerillt + 1/2 glatt, platte cm.59,5x45 - 2 Heizzonen

FR Plaque gaz 1/2 nervurée + 1/2 lisse, plaque cm.59,5x45 - 2 zones de cuisson

ES **FRY-TOP GAS 1/2 ESTRIADO + 1/2 LISO, PLANCHA CM.59,5X45 - 2 ZONAS DE COCCIÓN**

cm. 60 x 60 x 28h

 cm. 63 x 69 x 65h / kg 65 / m³ 0,283

 9 kW
7.740 kcal/h

€ 2.404,00

FTLRT-66GS

16230655

FRY-TOP GAS 1/2 RIGATO + 1/2 LISCIO CROMATO SUPERCHROME (MOCA APPROVED), PIASTRA CM.59,5X45 - 2 ZONE DI COTTURA

EN Gas Fry-top 1/2 grooved + 1/2 smooth chromed griddle SUPERCHROME (Moca Approved), plate cm.59,5x45 - 2 cooking areas

DE Gas-griddleplatte 1/2 gerillt + 1/2 glatt hartverchromt SUPERCHROME (Moca Approved), platte cm.59,5x45 - 2 Heizzonen

FR Plaque gaz 1/2 nervurée + 1/2 lisse chromée SUPERCHROME (Moca Approved), plaque cm.59,5x45 - 2 zones de cuisson

ES **FRY-TOP GAS 1/2 ESTRIADO + 1/2 LISO CROMADO SUPERCHROME (MOCA APPROVED), PLANCHA CM.59,5X45 - 2 ZONAS DE COCCIÓN**

cm. 60 x 60 x 28h

 cm. 63 x 69 x 65h / kg 65 / m³ 0,283

 9 kW
7.740 kcal/h

€ 2.757,00

FTRT-66G

16230653



FRY-TOP GAS RIGATO, PIASTRA CM.59,5X45 - 2 ZONE DI COTTURA

EN Gas Fry-top grooved griddle, plate cm.59,5x45 - 2 cooking areas**DE** Gas-griddleplatte gerillt, platte cm.59,5x45 - 2 Heizzonen**FR** Plaque gaz nervurée, plaque cm.59,5x45 - 2 zones de cuisson**ES** **FRY-TOP GAS ESTRIADO, PLANCHA CM.59,5X45 - 2 ZONAS DE COCCIÓN**

cm. 60 x 60 x 28h

 cm. 63 x 69 x 65h / kg 65 / m³ 0,283

 9 kW
7.740 kcal/h
€ 2.523,00**FTRT-66GS**

16230656

FRY-TOP GAS RIGATO CROMATO SUPERCHROME (MOCA APPROVED), PIASTRA CM.59,5X45 - 2 ZONE DI COTTURA

EN Gas Fry-top grooved chromed griddle SUPERCHROME (Moca Approved), plate cm.59,5x45 - 2 cooking areas**DE** Gas-griddleplatte gerillt hartverchromt SUPERCHROME (Moca Approved), platte cm.59,5x45 - 2 Heizzonen**FR** Plaque gaz nervurée chromée SUPERCHROME (Moca Approved), plaque cm.59,5x45 - 2 zones de cuisson**ES** **FRY-TOP GAS ESTRIADO CROMADO SUPERCHROME (MOCA APPROVED), PLANCHA CM.59,5X45 - 2 ZONAS DE COCCIÓN**

cm. 60 x 60 x 28h

 cm. 63 x 69 x 65h / kg 65 / m³ 0,283

 9 kW
7.740 kcal/h
€ 2.835,00**FTLT-68G**

16230851



FRY-TOP GAS LISCIO, PIASTRA CM.79,5X45 - 2 ZONE DI COTTURA

EN Gas Fry-top smooth griddle, plate cm.79,5x45 - 2 cooking areas**DE** Gas-griddleplatte glatt, platte cm.79,5x45 - 2 Heizzonen**FR** Plaque gaz lisse, plaque cm.79,5x45 - 2 zones de cuisson**ES** **FRY-TOP GAS LISO, PLANCHA CM.79,5X45 - 2 ZONAS DE COCCIÓN**

cm. 80 x 60 x 28h

 cm. 83 x 69 x 65h / kg 83 / m³ 0,372

 12 kW
10.320 kcal/h
€ 3.035,00**FTLT-68GS**

16230854

FRY-TOP GAS LISCIO CROMATO SUPERCHROME (MOCA APPROVED), PIASTRA CM.79,5X45 - 2 ZONE DI COTTURA

EN Gas Fry-top smooth chromed griddle SUPERCHROME (Moca Approved), plate cm.79,5x45 - 2 cooking areas**DE** Gas-griddleplatte glatt hartverchromt SUPERCHROME (Moca Approved), platte cm.79,5x45 - 2 Heizzonen**FR** Plaque gaz lisse chromée SUPERCHROME (Moca Approved), plaque cm.79,5x45 - 2 zones de cuisson**ES** **FRY-TOP GAS LISO CROMADO SUPERCHROME (MOCA APPROVED), PLANCHA CM.79,5X45 - 2 ZONAS DE COCCIÓN**

cm. 80 x 60 x 28h

 cm. 83 x 69 x 65h / kg 83 / m³ 0,372

 12 kW
10.320 kcal/h
€ 3.607,00**FTLT-68GSS**

16230850

FRY-TOP GAS LISCIO CROMO LUCIDO, PIASTRA CM.79,5X45 - 2 ZONE DI COTTURA

EN Gas Fry-top smooth POLISHED CHROME, plate cm.79,5x45 - 2 cooking areas**DE** Gas-griddleplatte glatt POLIERTEM CHROM, platte cm.79,5x45 - 2 Heizzonen**FR** Plaque gaz lisse CHROME POLI, plaque cm.79,5x45 - 2 zones de cuisson**ES** **FRY-TOP GAS LISO CROMO PULIDO, PLANCHA CM.79,5X45 - 2 ZONAS DE COCCIÓN**

cm. 80 x 60 x 28h

 cm. 83 x 69 x 65h / kg 83 / m³ 0,372

 12 kW
10.320 kcal/h
€ 3.607,00

FTLRT-68G

16230852



FRY-TOP GAS 1/2 RIGATO + 1/2 LISCIO, PIASTRA CM.79,5X45 - 2 ZONE DI COTTURA

EN Gas Fry-top 1/2 grooved + 1/2 smooth, plate cm.79,5x45 - 2 cooking areas

DE Gas-griddleplatte 1/2 gerillt + 1/2 glatt, platte cm.79,5x45 - 2 Heizzonen

FR Plaque gaz 1/2 nervurée + 1/2 lisse, plaque cm.79,5x45 - 2 zones de cuisson

ES **FRY-TOP GAS 1/2 ESTRIADO + 1/2 LISO, PLANCHA CM.79,5X45 - 2 ZONAS DE COCCIÓN**

cm. 80 x 60 x 28h

 cm. 83 x 69 x 65h / kg 83 / m³ 0,372

 12 kW
10.320 kcal/h

€ 3.145,00

FTLRT-68GS

16230855

FRY-TOP GAS 1/2 RIGATO + 1/2 LISCIO CROMATO SUPERCHROME (MOCA APPROVED), PIASTRA CM.79,5X45 - 2 ZONE DI COTTURA

EN Gas Fry-top 1/2 grooved + 1/2 smooth chromed griddle SUPERCHROME (Moca Approved), plate cm.79,5x45 - 2 cooking areas

DE Gas-griddleplatte 1/2 gerillt + 1/2 glatt hartverchromt SUPERCHROME (Moca Approved), platte cm.79,5x45 - 2 Heizzonen

FR Plaque gaz 1/2 nervurée + 1/2 lisse chromée SUPERCHROME (Moca Approved), plaque cm.79,5x45 - 2 zones de cuisson

ES **FRY-TOP GAS 1/2 ESTRIADO + 1/2 LISO CROMADO SUPERCHROME (MOCA APPROVED), PLANCHA CM.79,5X45 - 2 ZONAS DE COCCIÓN**

cm. 80 x 60 x 28h

 cm. 83 x 69 x 65h / kg 83 / m³ 0,372

 12 kW
10.320 kcal/h

€ 3.695,00

FTRT-68G

16230853



FRY-TOP GAS RIGATO, PIASTRA CM.79,5X45 - 2 ZONE DI COTTURA

EN Gas Fry-top grooved griddle, plate cm.79,5x45 - 2 cooking areas

DE Gas-griddleplatte gerillt, platte cm.79,5x45 - 2 Heizzonen

FR Plaque gaz nervurée, plaque cm.79,5x45 - 2 zones de cuisson

ES **FRY-TOP GAS ESTRIADO, PLANCHA CM.79,5X45 - 2 ZONAS DE COCCIÓN**

cm. 80 x 60 x 28h

 cm. 83 x 69 x 65h / kg 83 / m³ 0,372

 12 kW
10.320 kcal/h

€ 3.345,00

FTRT-68GS

16230856

FRY-TOP GAS RIGATO CROMATO SUPERCHROME (MOCA APPROVED), PIASTRA CM.79,5X45 - 2 ZONE DI COTTURA

EN Gas Fry-top grooved chromed griddle SUPERCHROME (Moca Approved), plate cm.79,5x45 - 2 cooking areas

DE Gas-griddleplatte gerillt hartverchromt SUPERCHROME (Moca Approved), platte cm.79,5x45 - 2 Heizzonen

FR Plaque gaz nervurée chromée SUPERCHROME (Moca Approved), plaque cm.79,5x45 - 2 zones de cuisson

ES **FRY-TOP GAS ESTRIADO CROMADO SUPERCHROME (MOCA APPROVED), PLANCHA CM.79,5X45 - 2 ZONAS DE COCCIÓN**

cm. 80 x 60 x 28h

 cm. 83 x 69 x 65h / kg 83 / m³ 0,372

 12 kW
10.320 kcal/h

€ 3.892,00

FTLT-610G

16231051



FRY-TOP GAS LISCIO, PIASTRA CM.99,5X45 - 2 ZONE DI COTTURA

EN Gas Fry-top smooth griddle, plate cm.99,5x45 - 2 cooking areas

DE Gas-griddleplatte glatt, platte cm.99,5x45 - 2 Heizzonen

FR Plaque gaz lisse, plaque cm.99,5x45 - 2 zones de cuisson

ES **FRY-TOP GAS LISO, PLANCHA CM.99,5X45 - 2 ZONAS DE COCCIÓN**

cm. 100 x 60 x 28h

 cm. 103 x 69 x 65h / kg 89 / m³ 0,462

 15 kW
12.900 kcal/h

€ 3.473,00

FTLT-610GS

16231054

FRY-TOP GAS LISCIO CROMATO SUPERCHROME (MOCA APPROVED), PIASTRA CM.99,5X45 - 2 ZONE DI COTTURA

EN Gas Fry-top smooth chromed griddle SUPERCHROME (Moca Approved), plate cm.99,5x45 - 2 cooking areas

DE Gas-griddleplatte glatt hartverchromt SUPERCHROME (Moca Approved), platte cm.99,5x45 - 2 Heizzonen

FR Plaque gaz lisse chromée SUPERCHROME (Moca Approved), plaque cm.99,5x45 - 2 zones de cuisson

ES **FRY-TOP GAS LISO CROMADO SUPERCHROME (MOCA APPROVED), PLANCHA CM.99,5X45 - 2 ZONAS DE COCCIÓN**

cm. 100 x 60 x 28h

cm. 103 x 69 x 65h / kg 89 / m³ 0,462

15 kW **€ 4.049,00**
12.900 kcal/h

**FTLT-610GSS**

16231050

FRY-TOP GAS LISCIO CROMO LUCIDO, PIASTRA CM.99,5X45 - 2 ZONE DI COTTURA

EN Gas Fry-top smooth POLISHED CHROME, plate cm.99,5x45 - 2 cooking areas

DE Gas-griddleplatte glatt POLIERTEM CHROM, platte cm.99,5x45 - 2 Heizzonen

FR Plaque gaz lisse CHROME POLI, plaque cm.99,5x45 - 2 zones de cuisson

ES **FRY-TOP GAS LISO CROMO PULIDO, PLANCHA CM.99,5X45 - 2 ZONAS DE COCCIÓN**

cm. 100 x 60 x 28h

cm. 103 x 69 x 65h / kg 89 / m³ 0,462

15 kW **€ 4.049,00**
12.900 kcal/h

**FTLRT-610G**

16231052

FRY-TOP GAS 2/5 RIGATO + 3/5 LISCIO, PIASTRA CM.99,5X45 - 2 ZONE DI COTTURA

EN Gas Fry-top 2/5 grooved + 3/5 smooth, plate cm.99,5x45 - 2 cooking areas

DE Gas-griddleplatte 2/5 gerillt + 3/5 glatt, platte cm.99,5x45 - 2 Heizzonen

FR Plaque gaz 2/5 nervurée + 3/5 lisse, plaque cm.99,5x45 - 2 zones de cuisson

ES **FRY-TOP GAS 2/5 ESTRIADO + 3/5 LISO, PLANCHA CM.99,5X45 - 2 ZONAS DE COCCIÓN**

cm. 100 x 60 x 28h

cm. 103 x 69 x 65h / kg 89 / m³ 0,462

15 kW **€ 3.661,00**
12.900 kcal/h

**FTLRT-610GS**

16231055

FRY-TOP GAS 2/5 RIGATO + 3/5 LISCIO CROMATO SUPERCHROME (MOCA APPROVED), PIASTRA CM.99,5X45 - 2 ZONE DI COTTURA

EN Gas Fry-top 2/5 grooved + 3/5 smooth chromed griddle SUPERCHROME (Moca Approved), plate cm.99,5x45 - 2 cooking areas

DE Gas-griddleplatte 2/5 gerillt + 3/5 glatt hartverchromt SUPERCHROME (Moca Approved), platte cm.99,5x45 - 2 Heizzonen

FR Plaque gaz 2/5 nervurée + 3/5 lisse chromée SUPERCHROME (Moca Approved), plaque cm.99,5x45 - 2 zones de cuisson

ES **FRY-TOP GAS 2/5 ESTRIADO + 3/5 LISO CROMADO SUPERCHROME (MOCA APPROVED), PLANCHA CM.99,5X45 - 2 ZONAS DE COCCIÓN**

cm. 100 x 60 x 28h

cm. 103 x 69 x 65h / kg 89 / m³ 0,462

15 kW **€ 4.225,00**
12.900 kcal/h

**GRIGLIE ELETTRICHE - TOP**

EN ELECTRIC GRILL - TOP **DE** ELEKTRO-WURSTBRATER - TOP **FR** CHARCOAL ÉLECTRIQUE - TOP **ES** BARBACOAS ELECTRICAS - TOP

CWKT-64ET

16080431

GRIGLIA CONTACT - COTTURA DIRETTA SU RESISTENZA IN ACCIAIO INOX CM. 27X35 RIBALTABILE

EN CONTACT Grill threephase - Stainless steel grill cm. 27x35

DE Wurstbrater dreiphasig KONTAKT - Einstellbarer Rost aus Nirosta cm. 27x35

FR Grillade triphase CONTACT - Grille inox cm 27x35

ES **PARRILLA TRIFÁSICO CONTACT - PARRILLA DE ACERO INOX REGULABLE CM 27X35**

cm. 40 x 60 x 28h

cm. 43 x 69 x 65h / kg 35 / m³ 0,193

3,36 kW **€ 2.894,00**
400V~3N
50/60 Hz



CWKT-68ET

16080831



GRIGLIA CONTACT - COTTURA DIRETTA SU RESISTENZA IN ACCIAIO INOX CM. 55X35 RIBALTABILE

EN CONTACT Grill threephase - Stainless steel grill cm. 55x35

DE Wurstbrater dreiphasig KONTAKT - Einstellbarer Rost aus Nirosta cm. 55x35

FR Grillade triphase CONTACT - Grille inox cm 55x35

ES PARRILLA TRIFÁSICO CONTACT - PARRILLA DE ACERO INOX REGULABLE CM 55X35

cm. 80 x 60 x 28h

 cm. 83 x 69 x 65h / kg 50 / m³ 0,372

 ⚡ 6,72 kW
 400V~3N
 50/60 Hz

€ 3.889,00
CWT-64ET

16080430



GRIGLIA ELETTRICA TRIFASE GRIGLIA IN ACCIAIO INOX CM. 38X42,5 REGOLABILE

EN Grill threephase - Stainless steel grill cm. 38x42,5

DE Wurstbrater dreiphasig Einstellbarer Rost aus Nirosta cm. 38x42,5

FR Grillade Triphase - Grille inox cm. 38x42,5

ES PARRILLA TRIFÁSICO PARRILLA DE ACERO INOX REGULABLE CM. 38X42,5

cm. 40 x 60 x 28h

 cm. 43 x 69 x 65h / kg 36 / m³ 0,193

 ⚡ 4,8 kW
 400V~3N
 230V~3
 50/60 Hz

€ 2.055,00
CWT-66ET

16080630



GRIGLIA ELETTRICA TRIFASE GRIGLIA IN ACCIAIO INOX CM. 58X42,5 REGOLABILE

EN Grill threephase - Stainless steel grill cm. 58x42,5

DE Wurstbrater dreiphasig Einstellbarer Rost aus Nirosta cm. 58x42,5

FR Grillade Triphase - Grille inox cm. 58x42,5

ES PARRILLA TRIFÁSICO PARRILLA DE ACERO INOX REGULABLE CM. 58X42,5

cm. 60 x 60 x 28h

 cm. 63 x 69 x 65h / kg 48 / m³ 0,283

 ⚡ 6,3 kW
 400V~3N
 230V~3
 50/60 Hz

€ 2.337,00
CWT-68ET

16080830



GRIGLIA ELETTRICA TRIFASE N. 2 GRIGLIE IN ACCIAIO INOX CM. 38X42,5 REGOLABILI 2 ZONE DI COTTURA

EN Grill threephase - N. 2 Stainless steel grill cm. 38x42,5 2 cooking areas

DE Wurstbrater dreiphasig - N. 2 einstellbarer Rost aus Nirosta cm. 38x42,5 - 2 Heizzonen

FR Grillade Triphase - N. 2 grilles réglables en acier inox cm. 38x42,5 - 2 zones de cuisson

ES PARRILLA TRIFÁSICO - N. 2 PARRILLAS DE ACERO INOX REGULABLE CM. 38X42,5 - 2 ZONAS DE COCCIÓN

cm. 80 x 60 x 28h

 cm. 83 x 69 x 65h / kg 52 / m³ 0,372

 ⚡ 9,6 kW
 400V~3N
 230V~3
 50/60 Hz

€ 3.211,00

GRIGLIE PIETRA LAVICA A GAS - TOP

EN GAS CHARCOAL GRILL - TOP DE GASLAVASTEIN GRILLS - TOP FR CHARCOAL EN PIERRE DE LAVE À GAZ - TOP ES BARBACOAS DE PIEDRA LÁVICA A GAS - TOP

CWT-64G

16250450



GRIGLIA A GAS-PIETRALAVICA GRIGLIA IN ACCIAIO INOX CM. 38X42,5 REGOLABILE

EN Lavastone grill gas - Stainless steel grill cm. 38x42,5

DE Gas-Lavasteingrill - Einstellbarer Rost aus Nirosta cm. 38x42,5

FR Grille à gaz en pierre de lave - Grille inox cm. 38x42,5

ES PARRILLA A GAS PIEDRA LÁVICA PARRILLA DE ACERO INOX REGULABLE CM. 38X42,5

cm. 40 x 60 x 28h

cm. 43 x 69 x 65h / kg 41 / m³ 0,193

5,8 kW
4.988 kcal/h

€ 2.147,00

CWT-66G

16250650



GRIGLIA A GAS-PIETRALAVICA GRIGLIA IN ACCIAIO INOX CM. 58X42,5 REGOLABILE

EN Lavastone grill gas - Stainless steel grill cm. 58x42,5

DE Gas-Lavasteingrill - Einstellbarer Rost aus Nirosta cm. 58x42,5

FR Grille à gaz en pierre de lave - Grille inox cm. 58x42,5

ES PARRILLA A GAS PIEDRA LÁVICA PARRILLA DE ACERO INOX REGULABLE CM. 58X42,5

cm. 60 x 60 x 28h

cm. 63 x 69 x 65h / kg 58 / m³ 0,283

8,9 kW
7.654 kcal/h

€ 2.574,00

CWT-68G

16250850



GRIGLIA A GAS-PIETRALAVICA N. 2 GRIGLIE IN ACCIAIO INOX CM. 38X42,5 REGOLABILI - 2 ZONE DI COTTURA

EN Lavastone grill gas N. 2 Stainless steel grill cm. 38x42,5 - 2 cooking areas

DE Gas-Lavasteingrill N. 2 einstellbarer Rost aus Nirosta cm. 38x42,5 - Heizzonen

FR Grille à gaz en pierre de lave N. 2 grilles réglables en acier inox cm. 38x42,5 - 2 zones de cuisson

ES PARRILLA A GAS PIEDRA LÁVICA N. 2 PARRILLAS DE ACERO INOX REGULABLE CM. 38X42,5 - 2 ZONAS DE COCCIÓN

cm. 80 x 60 x 28h

cm. 83 x 69 x 65h / kg 62 / m³ 0,372

11,6 kW
9.976 kcal/h

€ 3.458,00

FRIGGITRICI ELETTRICHE - TOP

EN ELECRTC FRYERS - TOP DE ELEKTRO-FRITEUSE - TOP FR FRITEUSE ÉLECTRIQUE - TOP ES FREIDORAS ELECTRICAS - TOP

F10T-63EM

16090310



FRIGGITRICE ELETTRICA MONOFASE - VASCA LT. 10 CM. 22X35X23H CON FILTRO E COPERCHIO - CESTO CM. 20X30X10H PRODUZIONE PATATE 8 KG/H

EN Fryer singlephase - Tank capacity 10 Lst. cm. 22x35x23h - Sieve and lid for pan - Basket cm. 20x30x10h - Production 8 kg/hr

DE Friteuse einphasig - Beckeninhalt lt. 10 cm. 22x35x23h - Einlegesieb und Deckel für Becken - Korb cm. 20x30x10h Pommes frites: 8 kg/pro Stunde

FR Friteuse monophasé - Cuve lt. 10 cm. 22x35x23h - Filtre, couvercle pour cuve - Panier 20x30x10h Production de pommes frites: 8 kg/h

ES FREIDORA MONOFÁSICA - CUBA 10 LT CM. 22X35X23H - FILTRO Y TAPA PARA CUBA - CESTA CM. 20X30X10H PRODUCCIÓN PATATAS 8 KG/H

cm. 30 x 60 x 28h

cm. 33 x 69 x 65h / kg 20 / m³ 0,148

3,65 kW
230V~
50/60 Hz

€ 1.409,00

F10T-63ET

16090330

FRIGGITRICE ELETTRICA TRIFASE - VASCA LT. 10 CM. 22X35X23H CON FILTRO E COPERCHIO - CESTO CM. 20X30X10H PRODUZIONE PATATE 10 KG/H

EN Fryer threephase - Tank capacity 10 Lst. cm. 22x35x23h - Sieve and lid for pan - Basket cm. 20x30x10h - Production 10 kg/hr

DE Friteuse dreiphasig - Beckeninhalt lt. 10 cm. 22x35x23h - Einlegesieb und Deckel für Becken - Korb cm. 20x30x10h - Pommes frites: 10 kg/pro Stunde

FR Friteuse triphase - Cuve lt. 10 cm. 22x35x23h - Filtre, couvercle pour cuve - Panier 20x30x10h Production de pommes frites: 10 kg/h

ES FREIDORA TRIFÁSICA - CUBA 10 LT CM. 22X35X23H - FILTRO Y TAPA PARA CUBA - CESTA CM. 20X30X10H PRODUCCIÓN PATATAS 10 KG/H

cm. 30 x 60 x 28h

cm. 33 x 69 x 65h / kg 21 / m³ 0,148

7,15 kW
400V~3N
50/60 Hz

€ 1.603,00

F2/10T-66ET

16090630



FRIGGITRICE ELETTRICA TRIFASE - VASCHE LT. 10+10 CM. 22X35X23H CON FILTRO E COPERCHIO - N. 2 CESTI CM. 20X30X10H PRODUZIONE PATATE 20 KG/H

- EN** Fryer threephase - Tank capacity 10+10 Lst. cm. 22x35x23h - Sieve and lid for pan - N. 2 baskets cm. 20x30x10h - Production 20 kg/hr
- DE** Friteuse dreiphasig - Beckeninhalt lt. 10+10cm. 22x35x23h - Einlegesieb und Deckel für Becken - N. 2 Korbe cm. 20x30x10h - Pommes frites: 20 kg/pro Stunde
- FR** Friteuse triphase - Cuves lt. 10+10 cm. 22x35x23h - Filtre, couvercle pour cuve - N. 2 paniers 20x30x10h Production de pommes frites: 20 kg/h

ES FREIDORA TRIFÁSICA - CUBA 10+10 LT. CM. 22X35X23H - FILTRO Y TAPA PARA CUBA - N. 2 CESTAS CM. 20X30X10H PRODUCCIÓN PATATAS 20 KG/H

cm. 60 x 60 x 28h

cm. 63 x 69 x 65h / kg 37 / m³ 0,283

14,3 kW
400V~3N
50/60 Hz

€ 2.835,00
F2/10T-66EM

16090610

FRIGGITRICE ELETTRICA MONOFASE - VACHE LT. 10+10 CM. 22X35X23H CON FILTRO E COPERCHIO - N. 2 CESTI CM. 20X30X10H PRODUZIONE PATATE 16 KG/H

- EN** Fryer singlephase - Tank capacity 10+10 Lst. cm. 22x35x23h - Sieve and lid for pan - N. 2 baskets cm. 20x30x10h Production 16 kg/hr
- DE** Friteuse einphasig - Beckeninhalt lt. 10+10cm. 22x35x23h - Einlegesieb und Deckel für Becken - N. 2 Korbe cm. 20x30x10h Pommes frites: 16 kg/pro Stunde
- FR** Friteuse monophasé - Cuves lt. 10+10 cm. 22x35x23h - Filtre, couvercle pour cuve - N. 2 paniers 20x30x10h Production de pommes frites: 16 kg/h

ES FREIDORA MONOFÁSICA - CUBA 10+10 LT. CM. 22X35X23H - FILTRO Y TAPA PARA CUBA - N. 2 CESTAS CM. 20X30X10H PRODUCCIÓN PATATAS 16 KG/H

cm. 60 x 60 x 28h

cm. 63 x 69 x 65h / kg 34 / m³ 0,283

7,3 kW
230V~
50/60 Hz

€ 2.448,00
FRIGGITRICI A GAS - TOP

EN GAS FRYERS - TOP DE GAS-FRITEUSE - TOP FR FRITEUSE À GAZ - TOP ES FREIDORAS A GAS - TOP

F8T-63G

16260350



FRIGGITRICE A GAS - VASCA LT. 8 CM. 22X27,5X22H - CON FILTRO E COPERCHIO - CESTO 20X24X9H - PRODUZIONE PATATE: 8 KG/H

- EN** Gas fryer - Tank capacity 8 lts. cm. 22x27,5x22h - Basket cm. 20x24x9h - Production: 8kg/h
- DE** Gas-einzelfriteuse - Beckeninhalt lt. 8 cm. 22x27,5x22h - Korb cm. 20x24x9h - Pommes frites: 8 kg/pro Stunde
- FR** Friteuse gaz - Cuve lt. 8 cm. 22x27,5x22h - Panier 20x24x9h Production de pommes frites: 8 kg/h

ES FREIDORA GAS - CUBA 8 LT. CM. 22X27,5X22H - CESTA CM. 20X24X9H PRODUCCIÓN PATATAS: 8 KG/H

cm. 30 x 60 x 28h

cm. 33 x 69 x 65h / kg 23 / m³ 0,148

6 kW
5.160 kcal/h

€ 1.881,00
F2/8T-66G

16260650



FRIGGITRICE A GAS - VASCHE LT. 8+8 CM. 22X27,5X22H - CON FILTRO E COPERCHIO - N. 2 CESTI 20X24X9H - PRODUZIONE PATATE: 16 KG/H

- EN** Gas fryer - Tank capacity 8+8 lts. cm. 22x27,5x22h - N. 2 baskets cm. 20x24x9h Production: 16 kg/h
- DE** Gas-einzelfriteuse - Beckeninhalt lt. 8+8 cm. 22x27,5x22h - N. 2 Korbe cm. 20x24x9h Pommes frites: 16 kg/pro Stunde
- FR** Friteuse gaz - Cuve lt. 8+8 cm. 22x27,5x22h - N. 2 paniers 20x24x9h - Production de pommes frites: 16 kg/h

ES FREIDORA GAS - CUBA 8+8 LT. CM. 22X27,5X22H - N. 2 CESTAS CM. 20X24X9H PRODUCCIÓN PATATAS: 16 KG/H

cm. 60 x 60 x 28h

cm. 63 x 69 x 65h / kg 41 / m³ 0,283

12 kW
10.320 kcal/h

€ 3.266,00

FRIGGITRICI ELETTRICHE

EN ELECRTIC FRYERS DE ELEKTRO-FRITEUSE FR FRITEUSE ÉLECTRIQUE ES FREIDORAS ELECTRICAS

F13-64ET
 06090430

FRIGGITRICE TRIFASE LT. 13 VASCA CM. 24X35X32H - 1 CESTO CM. 21X30X12H - FILTRO E COPERCHIO VASCA. BACINELLA RACCOGLIOLIO CON FILTRO. - PRODUZIONE PATATE: 10 KG/H

EN Fryer threephase 13 lts - Bowl cm. 24x35x32h - 1 basket cm. 21x30x12h. Sieve and lid for pan. - Drip tray with sieve. Production: 10 kg/h

DE Friteuse dreiphasig lt. 13 - Becken cm. 24x35x32h - 1 Korb cm. 21x30x12h. Einlegesieb und Deckel für Becken. - Fettauffangschale mit Sieb. Pommes frites: 10 kg/h

FR Friteuse triphase lt. 13 - Cuve cm. 24x35x32h - 1 Panier cm. 21x30x12h. Filtre, couvercle pour cuve. - Bac de récupération de l'huile avec filtre. Production de pommes frites: 10 kg/h

ES FREIDORAS TRIFÁSICO 13 LT. - CUBA CM. 24X35X32H - 1 CESTA CM. 21X30X12H. FILTRO Y TAPA PARA CUBA. BANDEJA RECOGE ACEITE CON FILTRO. PROD. PATATAS: 10 KG/H

cm. 40 x 60 x 90h

cm. 43 x 77 x 111h / kg 52 / m³ 0,368

10,95 kW
400V~3N
50/60 Hz

€ 2.662,00

FRIGGITRICI A GAS

EN GAS FRYERS DE GAS-FRITEUSE FR FRITEUSE À GAZ ES FREIDORAS A GAS

F13-64G
 06260450

FRIGGITRICE GAS LT. 13 VASCA CM. 32,5X31,5X36H - 1 CESTO CM. 30X27,5X12H - FILTRO E COPERCHIO VASCA. BACINELLA RACCOGLIOLIO CON FILTRO. - PRODUZIONE PATATE: 10 KG/H

EN Gas fryer 13 lts - Bowl cm. 32,5x31,5x36h - 1 basket cm. 30x27,5x12h. Sieve and lid for pan. - Drip tray with sieve. Production: 10 kg/h

DE Gas-Friteuse lt. 13 - Becken cm. 32,5x31,5x36h - 1 Korb cm. 30x27,5x12h. Einlegesieb und Deckel für Becken. - Fettauffangschale mit Sieb. Pommes frites: 10 kg/h

FR Friteuse a gaz lt. 13 - Cuve cm. 32,5x31,5x36h - 1 Panier cm. 30x27,5x12h. Filtre, couvercle pour cuve. - Bac de récupération de l'huile avec filtre. Production de pommes frites: 10 kg/h

ES FREIDORAS A GAS 13 LT. - CUBA CM. 32,5X31,5X36H - 1 CESTA CM. 30X27,5X12H. FILTRO Y TAPA PARA CUBA. BANDEJA RECOGE ACEITE CON FILTRO. PROD. PATATAS: 10 KG/H

cm. 40 x 60 x 90h

cm. 43 x 77 x 111h / kg 60 / m³ 0,368

10,5 kW
9.020 kcal/h

€ 3.001,00

BRASIERE FISSE MULTIFUNZIONE ELETTRICHE - TOP

EN FIXED ELECTRIC BRATT PANS - TOP DE ELEKTRO MULTIFUNKTIONSBRATPFANNE FEST - TOP FR SAUTEUSE FIXE ÉLECTRIQUE - TOP ES SARTEN FIJA ELECTRICA - TOP

BRT-66ET
 16070630

BRASIERA TRIFASE - LT. 20 VASCA CM. 50,5X41X10H

EN Bratt-pan threephase - Tank capacity 20 lts. - Pan cm. 50,5x41x10 h

DE Bratpfanne dreiphasig - Lt. 20 - Becken cm. 50,5x41x10 h

FR Sauteuse triphase - Lt. 20 - Bac cm. 50,5x41x10h

ES SARTÉN TRIFÁSICA - 20 LT. - CUBA CM. 50,5X41X10H

cm. 60 x 60 x 28h

cm. 63 x 69 x 65h / kg 45 / m³ 0,283

6 kW
400V~3N
230V~3
50/60 Hz

€ 2.251,00

BRASIERE FISSE MULTIFUNZIONE A GAS - TOP
EN FIXED GAS BRATT PANS - TOP **DE** GAS MULTIFUNKTIONSBRATPFANNE FEST - TOP **FR** SAUTEUSE FIXE A GAZ - TOP **ES** SARTEN FIJA DE GAS - TOP

BRT-66G
16240650

 BRASIERA GAS - LT. 20 VASCA CM. 50,5X41X10H
EN Gas bratt-pan - Capacity 20 litres - Pan cm. 50,5x41x10 h
DE Gas Bratpfanne - lt. 20 - Becken cm. 50,5x41x10 h
FR Sauteuse gaz - lt. 20 - Bac cm. 50,5x41x10h
ES **SARTÉN GAS - 20 L. - CUBA CM. 50,5X41X10H**
 cm. 60 x 60 x 28h
 cm. 63 x 69 x 65h / kg 46 / m³ 0,283

 6,9 kW
5.930 kcal/h
€ 2.742,00
PIANI LAVORO - TOP
EN WORK TOP - TOP **DE** ARBEITSPLATTE - TOP **FR** PLAN DE TRAVAIL - TOP **ES** ENCIMERA DE TRABAJO - TOP

PLT-62
16010200

 PIANO DI LAVORO
EN Worktop
DE Arbeitsplatte
FR Plan de travail
ES **SOBRE DE TRABAJO**
 cm. 20 x 60 x 28h
 cm. 33 x 69 x 65h / kg 13 / m³ 0,148

€ 524,00
PLT-63
16010300

 PIANO DI LAVORO CON CASSETTO INOX CM.21X47X15H INOX
EN Worktop with inox drawer cm.21x47x15h inox
DE Arbeitsplatte mit Schublade inox cm.21x47x15h inox
FR Plan de travail avec tiroir inox cm.21x47x15h inox
ES **SOBRE DE TRABAJO CON CAJÓN INOX CM.21X47X15H INOX**
 cm. 30 x 60 x 28h
 cm. 33 x 69 x 65h / kg 21 / m³ 0,148

€ 670,00
PLT-64
16010400

 PIANO DI LAVORO CON CASSETTO INOX CM.31X47X15H INOX
EN Worktop with inox drawer cm.31x47x15h inox
DE Arbeitsplatte mit Schublade inox cm.31x47x15h inox
FR Plan de travail avec tiroir inox cm.31x47x15h inox
ES **SOBRE DE TRABAJO CON CAJÓN INOX CM.31X47X15H INOX**
 cm. 40 x 60 x 28h
 cm. 43 x 69 x 65h / kg 22 / m³ 0,193

€ 705,00

PLT-66
 16010600

PIANO DI LAVORO CON CASSETTO INOX CM.51X47X15H INOX

EN Worktop with inox drawer cm.51x47x15h inox

DE Arbeitsplatte mit Schublade inox cm.51x47x15h inox

FR Plan de travail avec tiroir inox cm.51x47x15h inox

ES **SOBRE DE TRABAJO CON CAJÓN INOX CM.51X47X15H INOX**

cm. 60 x 60 x 28h

 cm. 63 x 69 x 65h / kg 25 / m³ 0,283

€ 1.007,00
PLT-68
 16010800

PIANO DI LAVORO CON CASSETTO INOX CM.71X47X15H INOX

EN Worktop with inox drawer cm.71x47x15h inox

DE Arbeitsplatte mit Schublade inox cm.71x47x15h inox

FR Plan de travail avec tiroir inox cm.71x47x15h inox

ES **SOBRE DE TRABAJO CON CAJÓN INOX CM.71X47X15H INOX**

cm. 80 x 60 x 28h

 cm. 83 x 69 x 65h / kg 38 / m³ 0,372

€ 1.176,00
PLT-610
 16011000

PIANO DI LAVORO CON 2 CASSETTI INOX, 1XCM.51X47X15H + 1XCM.31X47X15H

EN Worktop with 2 inox drawers, 1xcm.51x47x15h + 1xcm.31x47x15h

DE Arbeitsplatte mit 2 Schublade inox, 1xcm.51x47x15h + 1xcm.31x47x15h

FR Plan de travail avec 2 tiroirs inox, 1xcm.51x47x15h + 1xcm.31x47x15h

ES **SOBRE DE TRABAJO CON 2 CAJONES INOX, 1XCM.51X47X15H + 1XCM.31X47X15H**

cm. 100 x 60 x 28h

 cm. 103 x 69 x 65h / kg 51 / m³ 0,462

€ 1.632,00
PIANO DI LAVORO AD ANGOLO
EN CORNER WORKTOP **DE** ECKSCHRANK **FR** PLAN DE TRAVAIL D'ANGLE **ES** **SOBRE DE TRABAJO ANGULAR**
PLA-68
 06010801

PIANO DI LAVORO AD ANGOLO SU MOBILE

EN Corner base with door

DE Eckschrank mit Tür

FR Placard d'angle avec porte

ES **BASE ANGULAR CON PUERTA**

cm.80÷80 x 60 x 90h

 cm. 83 x 97 x 111h / kg 50 / m³ 0,894

€ 1.947,00

LAVELLI - TOP
EN SINK UNIT - TOP DE SPÜLBECKEN - TOP FR ÉVIER - TOP ES FREGADEROS - TOP
LAT-64
 16020400

LAVELLO 1 VASCA RUBINETTO A LEVA - VASCA CM 29X35X14H
EN Sink unit - Lever type tap - Bowl cm 29x35x14h
DE Spülbecken - Einhebel-Mischbatterie Becken cm 29x35x14h
FR Bac-évier avec robinetterie - Bac cm 29x35x14h
ES **FREGADERO - GRIFO A PALANCA - PILETA CM 29X35X14H**

cm. 40 x 60 x 28h
 cm. 43 x 69 x 65h / kg 20 / m³ 0,193

€ 1.076,00
LAVELLO AD ANGOLO SU MOBILE
EN CORNER SINK UNIT DE ECKSCHRANK MIT SPÜLBECKEN FR ÉVIER SUR PLACARD D'ANGLE ES FREGADEROS SOBRE BASE ANGULAR
LAA-68
 06020801

LAVELLO AD ANGOLO SU MOBILE VASCA CM 50X40X20H
EN Corner base with sink and door Bowl cm 50x40x20h
DE Eckschrank mit Spülbecken und mit Tür Becken cm 50x40x20h
FR Placard d'angle avec porte et evier Cuve cm 50x40x20h
ES **CON FREGADERO Y PUERTA CM. CUBA CM 50X40X20H**

cm. 80÷80 x 60 x 90h
 cm. 83 x 97 x 111h / kg 50 / m³ 0,894

€ 2.293,00
BASE CON FORNO ELETTRICO
EN STAND WITH ELECTRIC OVEN DE UNTERBAU MIT ELEKTRO ÖFEN FR PALCARD AVEC FOUR ÉLECTRIQUE ES MUEBLE CON HORNO ELECTRICO
MFM-68EM/V
 06490812

BASE CON FORNO ELETTRICO MULTIFUNZIONE CM. 46X37X35H, TEMP: 50÷250°C, CON 1 GRIGLIA CM.41X32,5 - PORTA VETRO (NON SOVRAPPORRE ELEMENTI AD INDUZIONE)
EN Stand with Multifunction electric oven cm. 46x37x35h, temp: 50÷250°C, with 1 grid cm.41x32,5 - Glass door (no induction top)
DE unterbau mit Multifunktions-Elektroofen cm. 46x37x35h, temp: 50÷250°C, mit 1 Rost cm.41x32,5 - Glastür (nicht Induktions)
FR placard avec Four électrique à fonctions multiples cm. 46x37x35h, temp: 50÷250°C, avec 1 grille cm.41x32,5 - Porte vitrée (il faut pas de induction)
ES **MUEBLE CON HORNO ELÉCTRICO MULTIFUNCIONAL CM. 46X37X35H, TEMP: 50÷250°C, CON 1 PARILLA CM.41X32,5 - PUERTA VIDRIO (NO INDUCCIÓN)**

cm. 80 x 57,5 x 57h
 cm. 83 x 67 x 77h / kg 51 / m³ 0,428

\nearrow 3,05 kW	€ 3.040,00
230V~	
50/60 Hz	

MFM-68EM
 06490813

BASE CON FORNO ELETTRICO MULTIFUNZIONE CM. 46X37X35H, TEMP: 50÷250°C, CON 1 GRIGLIA CM.41X32,5 - PORTA CIEGA INOX (NON SOVRAPPORRE ELEMENTI AD INDUZIONE)
EN Stand with Multifunction electric oven cm. 46x37x35h, temp: 50÷250°C, with 1 grid cm.41x32,5 - Stainless steel door (no induction top)
DE unterbau mit Multifunktions-Elektroofen cm. 46x37x35h, temp: 50÷250°C, mit 1 Rost cm.41x32,5 - Edelstahltür (nicht Induktions)
FR placard avec Four électrique à fonctions multiples cm. 46x37x35h, temp: 50÷250°C, avec 1 grille cm.41x32,5 - Porte acier inoxydable (il faut pas de induction)
ES **MUEBLE CON HORNO ELÉCTRICO MULTIFUNCIONAL CM. 46X37X35H, TEMP: 50÷250°C, CON 1 PARILLA CM.41X32,5 - PUERTA CIEGA INOX (NO INDUCCIÓN)**

cm. 80 x 57,5 x 57h
 cm. 83 x 67 x 77h / kg 51 / m³ 0,428

\nearrow 3,05 Kw	€ 3.040,00
230V~	
50/60 Hz	

MFM-610EM/V

06491012



BASE CON FORNO ELETTRICO MULTIFUNZIONE CM. 64X37X35H, TEMP: 50÷250°C, CON 1 GRIGLIA CM.53X32,5 GN1/1 - PORTA VETRO (NON SOVRAPPORRE ELEMENTI AD INDUZIONE)

- EN** Stand with Multifunction electric oven cm. 64x37x35h, temp: 50÷250°C, with 1 grid cm.53x32,5 GN1/1 - Glass door (no induction top)
- DE** unterbau mit Multifunktions-Elektroofen cm. 64x37x35h, temp: 50÷250°C, mit 1 Rost cm.53x32,5 GN1/1 - Glastür (nicht Induktions)
- FR** placard avec Four électrique à fonctions multiples cm. 64x37x35h, temp: 50÷250°C, avec 1 grille cm.53x32,5 GN1/1 - Porte vitrée (il faut pas de induction)
- ES** **MUEBLE CON HORNO ELÉCTRICO MULTIFUNCIONAL CM. 64X37X35H, TEMP: 50÷250°C, CON 1 PARILLA CM.53X32,5 GN1/1 - PUERTA VIDRIO (NO INDUCCIÓN)**

 cm. 100 x 57,5 x 57h

 cm. 103 x 67 x 77h / kg 59 / m³ 0,531

 3,05 kW
230V~
50/60 Hz

€ 3.358,00**MFM-610EM**

06491013



BASE CON FORNO ELETTRICO MULTIFUNZIONE CM. 64X37X35H, TEMP: 50÷250°C, CON 1 GRIGLIA CM.53X32,5 GN1/1 - PORTA CIECA INOX (NON SOVRAPPORRE ELEMENTI AD INDUZIONE)

- EN** Stand with Multifunction electric oven cm. 64x37x35h, temp: 50÷250°C, with 1 grid cm.53x32,5 GN1/1 - Stainless steel door (no induction top)
- DE** unterbau mit Multifunktions-Elektroofen cm. 64x37x35h, temp: 50÷250°C, mit 1 Rost cm.53x32,5 GN1/1 - Edelstahltür (nicht Induktions)
- FR** placard avec Four électrique à fonctions multiples cm. 64x37x35h, temp: 50÷250°C, avec 1 grille cm.53x32,5 GN1/1 - Porte acier inoxydable (il faut pas de induction)
- ES** **MUEBLE CON HORNO ELÉCTRICO MULTIFUNCIONAL CM. 64X37X35H, TEMP: 50÷250°C, CON 1 PARILLA CM.53X32,5 GN1/1 - PUERTA CIEGA INOX (NO INDUCCIÓN)**

 cm. 100 x 57,5 x 57h

 cm. 103 x 67 x 77h / kg 59 / m³ 0,531

 3,05 kW
230V~
50/60 Hz

€ 3.358,00

60 MAGICLOTUS ACC60 MAGICLOTUS
ACC

MOBILI BASE
EN STAND DE UNTERBAU FR MEUBLE NEUTRE ES MUEBLE
MPI-64

06410403



BASE CON PORTA PER INDUZIONE

EN Stand with door for induction top

DE Unterbau für Induktions mit Tür

FR Placard pour induction avec porte

ES MUEBLE BASE PARA INDUCCIÓN CON PUERTA

cm. 40 x 51 x 57h

 cm. 43 x 69 x 65h / kg 18,5 / m³ 0,193

€ 678,00
M-62

06410200



BASE NEUTRA

EN Stand

DE Unterbau

FR Placard

ES MUEBLE BASE

cm. 20 x 48,5 x 57h

 cm. 73 x 63 x 37h / kg 11 / m³ 0,170

€ 401,00
M-63

06410300



BASE NEUTRA A GIORNO

EN Open Stand

DE Offener Unterbau

FR Placard ouvert

ES MUEBLE BASE ABIERTO

cm. 30 x 48,5 x 57h

 cm. 33 x 69 x 65h / kg 13 / m³ 0,148

€ 390,00
M-64

06410400

cm. 40 x 48,5 x 57h

 cm. 43 x 69 x 65h / kg 15 / m³ 0,193

€ 436,00
M-66

06410600

cm. 60 x 48,5 x 57h

 cm. 63 x 69 x 65h / kg 19 / m³ 0,283

€ 483,00

M-67

06410700

cm. 70 x 48,5 x 57h

 cm. 83 x 69 x 65h / kg 20 / m³ 0,372

€ 529,00

M-68

06410800

cm. 80 x 48,5 x 57h

 cm. 83 x 69 x 65h / kg 22 / m³ 0,372

€ 565,00

M-69

06410900



BASE NEUTRA A GIORNO 30/60

- EN** Open Stand 30/60
- DE** Offener Unterbau 30/60
- FR** Placard ouvert 30/60
- ES** **MUEBLE BASE ABIERTO 30/60**

- cm. 90 x 48,5 x 57h
- cm. 103 x 67 x 77h / kg 25 / m³ 0,531

€ 705,00**M-610**

06411000



BASE NEUTRA A GIORNO 40/60

- EN** Open Stand 40/60
- DE** Offener Unterbau 40/60
- FR** Placard ouvert 40/60
- ES** **MUEBLE BASE ABIERTO 40/60**

- cm. 100 x 48,5 x 57h
- cm. 103 x 67 x 77h / kg 27 / m³ 0,531

€ 738,00**M-612**

06411200



BASE NEUTRA A GIORNO 40/80

- EN** Open Stand 40/80
- DE** Offener Unterbau 40/80
- FR** Placard ouvert 40/80
- ES** **MUEBLE BASE ABIERTO 40/80**

- cm. 120 x 48,5 x 57h
- cm. 123 x 69 x 65h / kg 32 / m³ 0,552

€ 787,00**ACCESSORI****EN** ACCESSORIES **DE** ZUBEHÖR **FR** ACCESSOIRES **ES** **ACCESORIOS****PM-63/73/93-DX**

08430302



PORTA 300 DESTRA

- EN** Right door 300
- DE** Rechte tür 300
- FR** Porte droite 300
- ES** **PUERTA DERECHA 300**

- cm. 29,5 x 2,5 x 47,5h
- cm. 33 x 7 x 58h / kg 3 / m³ 0,013

€ 219,00**PM-64/74/94-DX**

08430402

PORTA 400 DESTRA

- EN** Right door 400
- DE** Rechte tür 400
- FR** Porte droite 400
- ES** **PUERTA DERECHA 400**

- cm. 39,5 x 2,5 x 47,5h
- cm. 43 x 7 x 58h / kg 3.5 / m³ 0,017

€ 227,00

PM-63/73/93-SX
 08430303

PORTA 300 SINISTRA
EN Left door 300
DE Linke tür 300
FR Porte gauche 300
ES **PUERTA IZQUIERDA 300**
 cm. 29,5 x 2,5 x 47,5h
 cm. 33 x 7 x 58h / kg 3 / m³ 0,013

€ 219,00
PM-64/74/94-SX
 08430403

PORTA 400 SINISTRA
EN Left door 400
DE Linke tür 400
FR Porte gauche 400
ES **PUERTA IZQUIERDA 400**
 cm. 39,5 x 2,5 x 47,5h
 cm. 43 x 7 x 58h / kg 3.5 / m³ 0,017

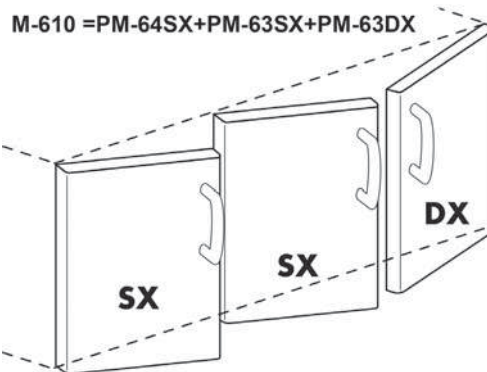
€ 227,00

C-63
 06440320

CASSETTIERA 300/400/600 - N. 2 CASSETTI CON VASCA INOX GUIDE TELESOPICHE
EN Drawer set 300/400/600 - N. 2 drawers with inox pans, telescopic guides
DE Schubladen 300/400/600 - N. 2 Schubladen mit chromnickelstahl Telescopeinführungen
FR Tiroirs pour meuble de 300/400/600 - N. 2 tiroirs avec cuve inox, Guides télescopiques
ES **CAJONERA 300/400/600 - N. 2 CAJONES CON CUBA DE ACERO INOX, GUÍAS TELESCÓPICAS**
 cm. 29,5 x 51 x 47,5h
 cm. 33 x 69 x 65h / kg 8 / m³ 0,148

€ 765,00
C-64
 06440420

cm. 39,5 x 51 x 47,5h
 cm. 43 x 69 x 65h / kg 9 / m³ 0,193

€ 788,00
C-66
 06440620

cm. 59,5 x 51 x 47,5h
 cm. 63 x 69 x 65h / kg 14 / m³ 0,283

€ 922,00

D-60

06470000



DIVISORIO - NECESSARIO PER APPLICARE CASSETTIERA C-64 SU MOBILE 70/80

€ 170,00**EN** Spacer - For installation of a C-64 on a stand 70/80**DE** Trennwand - Um ein C-64 an einem Unterschrank 70/80 einzubauen**FR** Separation - Pour l'installation de C-64 sur placard 70/80**ES** **DIVISORIO - NECESARIO PARA APLICAR CAJONERAS C-64 EN MUEBLE 70/80**

↕ cm. 5 x 48 x 38h

📦 cm. 7 x 50 x 44h / kg 2 / m³ 0,015**R-63**

06450300



RIPIANO 300

€ 92,00**EN** Shelf 300**DE** Zwischenboden 300**FR** Étagère 300**ES** **ESTANTE 300**

↕ cm. 25 x 48 x 3,5h

📦 cm. 27 x 50 x 4h / kg 1,5 / m³ 0,005**R-64**

06450400

RIPIANO 400

€ 104,00**EN** Shelf 400**DE** Zwischenboden 400**FR** Étagère 400**ES** **ESTANTE 400**

↕ cm. 35 x 48 x 3,5h

📦 cm. 37 x 50 x 4h / kg 2,5 / m³ 0,007**R-66**

06450600



RIPIANO 600

€ 117,00**EN** Shelf 600**DE** Zwischenboden 600**FR** Étagère 600**ES** **ESTANTE 600**

↕ cm. 55 x 48 x 3,5h

📦 cm. 57 x 50 x 4h / kg 3 / m³ 0,011**R-68**

06450800

RIPIANO 800

€ 125,00**EN** Shelf 800**DE** Zwischenboden 800**FR** Étagère 800**ES** **ESTANTE 800**

↕ cm. 75 x 48 x 3,5h

📦 cm. 77 x 50 x 4h / kg 4 / m³ 0,015**PT-64**

06460002



PORTATEGLIE VANO - 400 (GN2/3) - VANO 600 (GN1/1)

€ 357,00**EN** Frame for oven plates. 400 GN 2/3 - 600 GN 1/1**DE** Aufangeschienen für Backbleche. 400 GN 2/3 - 600 GN 1/1**FR** Kit porte-plaques. 400 GN 2/3 - 600 GN 1/1**ES** **PORTACAZUELAS. 400 GN 2/3 - 600 GN 1/1**

↕ cm. 2 x 47 x 30h

📦 cm. 5 x 50 x 32h / kg 2.5 / m³ 0,008

CG-60
06560000



COPRIGIUNTO
EN Joint cover
DE Klemmsteg
FR Couvre-joint
ES **CUBRE JUNTA**
 ↳ cm. 0,7 x 52 x 1,2h
 ☞ cm. 3 x 55 x 3h / kg 0.12 / m³ 0,001

€ 39,00

TG-63
06580300

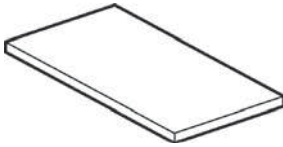

TAGLIERE PLASTICA
EN Plastic chopping-board
DE Schneidebrett
FR Plan de decoupe
ES **PICADOR DE PLÁSTICO**
 ↳ cm. 29 x 52,5 x 2,5h
 ☞ cm. 31 x 55 x 4h / kg 4 / m³ 0,007

€ 143,00

TG-64
06580400

↳ cm. 39 x 52,5 x 2,5h
 ☞ cm. 41 x 55 x 4h / kg 6 / m³ 0,009

€ 156,00

TG-66
06580600

↳ cm. 59 x 52,5 x 2,5h
 ☞ cm. 61 x 55 x 4h / kg 9 / m³ 0,013

€ 260,00

TG-68
06580800

↳ cm. 79 x 52,5 x 2,5h
 ☞ cm. 81 x 55 x 4h / kg 11 / m³ 0,018

€ 306,00

PT2/3-CFM66
06460023

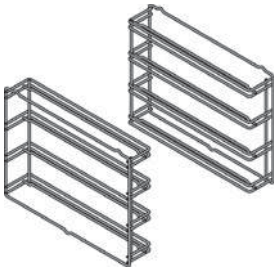

PORTATEGLIE GN 2/3. PER CFM-66
EN Frame for oven plates GN 2/3, for CFM-66
DE Auflangeschienen für Backbleche GN 2/3 für CFM-66
FR Kit porte-plaques GN 2/3 pour CFM-66
ES **PORTACAZUELAS GN2/3 PARA CFM-66**

☞ cm. 45 x 40 x 10h / kg 5 / m³ 0,018

€ 102,00

533009200



GRIGLIA DI RIDUZIONE
EN Reduction
DE Reduzierstern
FR Grille de réduction
ES **REJILLA DE REDUCCIÓN**

↳ cm. 25 x 25
 ☞ cm. 28 x 28 x 2h / kg 0.2 / m³ 0,002

€ 44,00

KIT-WOK
09580040



KIT WOK - FIAMMA VERTICALE - SOLO SU BRUCIATORE DA 10 KW E GRIGLIE IN GHISA
EN KIT WOK - vertical flame - only for 10 kW burner and cast iron grills
DE KIT WOK - vertikaler Flamme - nur 10 kW-Brenner und Roste aus Gusseisen
FR KIT WOK - verticale de la flamme - seulement 10 kW brûleur et grilles en fonte
ES **KIT WOK - LLAMA VERTICAL - SÓLO 10 KW QUEMADOR Y PARRILAS DE HIERRO COLADO**

↳ cm. Ø 26 x 16h
 ☞ cm. 27 x 27 x 20h / kg 5 / m³ 0,015

€ 470,00

PLF/62 06590421	PIASTRA LISCIA 2 FUOCHI EN Smooth griddle plate 2 burners DE Fortkochplatte glatt 2 Kochstellen FR Plaque lisse 2 feux ES PLANCHA LISA 2 QUEMADORES cm. 29 x 50 cm. 32 x 53 x 6h / kg 15 / m ³ 0,010	€ 254,00
PRF/62 06590423	PIASTRA RIGATA 2 FUOCHI EN Grooved griddle plate 2 burners DE Fortkochplatte gerillt 2 Kochstellen FR Plaque nervurée 2 feux ES PLANCHA ESTRIADA 2 QUEMADORES cm. 29 x 50 cm. 32 x 53 x 6h / kg 15 / m ³ 0,010	€ 372,00
RV 08660410	RISCALDANTE VANO EN Heater for cabinet DE Heizer für Schrankelement FR Réchauffeur pour armoire ES ELEMENTO DE CALEFACCIÓN PARA ARMARIO NEUTRO cm. 32 x 48,5 x 8h cm. 48 x 62 x 28h / kg 8 / m ³ 0,083	€ 1.004,00 0,75 kW 230V~ 50/60 Hz
RRV-64 06450401	RIPIANO FORATO IN APPOGGIO PER RISCALDANTE (NO CF) EN Perforated shelf for heater element mod.RV (NO CF) DE regale Gelocht für Heizer mod.RV (NO CF) FR Étagère perforées pour réchauffeur mod.RV (NO CF) ES ESTANTE PERFORADO PARA ELEMENTO DE CALEFACCION MOD.RV (NO CF) cm. 34 x 46 x 10h cm. 37 x 50 x 13h / kg 4 / m ³ 0,024	€ 347,00
RRV-66 06450601	cm. 54 x 46 x 10h cm. 57 x 50 x 13h / kg 5 / m ³ 0,037	€ 522,00
RRV-67 06450701	cm. 64 x 46 x 10h cm. 67 x 50 x 13h / kg 6 / m ³ 0,044	€ 657,00
RRV-68 06450801	cm. 74 x 46 x 10h cm. 77 x 50 x 13h / kg 7 / m ³ 0,050	€ 669,00
RRV-69 06450901	cm. 84 x 46 x 10h cm. 87 x 50 x 13h / kg 8 / m ³ 0,057	€ 841,00
RRV-610 06451001	cm. 94 x 46 x 10h cm. 97 x 50 x 13h / kg 10 / m ³ 0,063	€ 946,00
RRV-612 06451201	cm. 114 x 46 x 10h cm. 117 x 50 x 13h / kg 12 / m ³ 0,076	€ 1.125,00

SIA-7/9

08480000

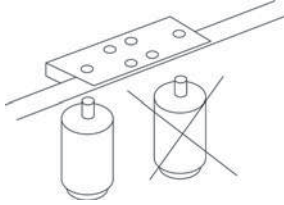

STAFFA INFERIORE UNIONE APPARECCHI

- EN** Lower bracket to join two items
- DE** Unterer Halter zur Verbindung zweier Teile
- FR** Support inférieur permettant d'assembler deux éléments
- ES** **SOPORTE INFERIOR PARA UNIR DOS ELEMENTOS**

 cm. 21 x 11 x 10h / kg 2 / m³ 0,002

€ 66,00
SR-100

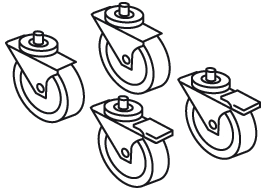
50900001

SET 4 RUOTE Ø 100X30, 2 CON FRENO

- EN** Set of 4 wheels Ø 100x30, 2 with brake
- DE** 4 Rollen Satz Ø 100x30, 2 davon mit Feststellbremse
- FR** Kit 4 roues Ø 100x30, 2 avec frein
- ES** **EQUIPO 4 RUEDAS Ø 100X30, 2 CON FRENOS**

cm. 12,7h

 cm. 30 x 20 x 20h / kg 1 / m³ 0,012

€ 395,00
ZB

01410000

ZOCCOLATURA BASE

- EN** FRONT PLINTH
- DE** GRUNDSOCKEL
- FR** PLINTHE FRONTAL
- ES** **ZOCOLOS BASE**

€/m x cm. 15h

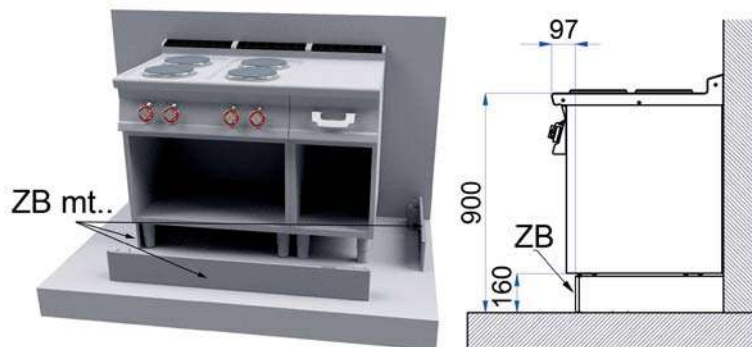
€ 159,00

ZA

01410002

ZOCCOLATURA ANGOLO

- EN** CORNER PLINTH
- DE** EKE-SOCKEL
- FR** PLINTHE ANGLE
- ES** **ZOCOLOS ANGULAR**

cm. 15h

 cm. 45 x 10 x 20h / kg 0.3 / m³ 0,009

€ 96,00
TMA-6SX

06540601

TESTATA 1 LATO SERIE 60 SINISTRA

- EN** Head 1 side S60 left
- DE** Abschluss element 1 seite S60 links
- FR** Element de jonction 1 coté S60 gauche
- ES** **EMBELLECEDOR 1 LADO S60 IZQUIERDA**

cm. 0,2 x 60

 cm. 100 x 3 x 100h / kg 7 / m³ 0,030

€ 274,00

TMA-6DX

06540600



TESTATA 1 LATO SERIE 60 DESTRA

- EN** Head 1 side S60 right
- DE** Abschluss element 1 seite S60 recht
- FR** Element de jonction 1 coté S60 droit
- ES** **EMBELLECEDOR 1 LADO S60 DERECHA**

cm. 0,2 x 60

 cm. 100 x 3 x 100h / kg 7 / m³ 0,030

€ 274,00

TMA-66

06546600



TESTATA 2 LATI SERIE 60

- EN** Head 2 sides S60
- DE** Abschluss element seiten S60
- FR** Element de jonction 2 cotés S60
- ES** **EMBELLECEDOR 2 LADOS S60**

cm. 0,2 x 120

 cm. 200 x 3 x 100h / kg 14 / m³ 0,060

€ 550,00

TMA-67SX

06546701



TESTATA 2 LATI SERIE 60/70 SINISTRA

- EN** Head 2 sides S60/70 left
- DE** Abschluss element seiten S60/70 links
- FR** Element de jonction 2 cotés S60/70 gauche
- ES** **EMBELLECEDOR 2 LADOS S60/70 IZQUIERDA**

cm. 0,2 x 130,5

 cm. 200 x 3 x 100h / kg 15 / m³ 0,060

€ 562,00

TMA-67DX

06546700



TESTATA 2 LATI SERIE 60/70 DESTRA

- EN** Head 2 sides S60/70 right
- DE** Abschluss element seiten S60/70 recht
- FR** Element de jonction 2 cotés S60/70 droit
- ES** **EMBELLECEDOR 2 LADOS S60/70 DERECHA**

cm. 0,2 x 130,5

 cm. 200 x 3 x 100h / kg 15 / m³ 0,060

€ 562,00

TMA-69SX

06546901



TESTATA 2 LATI SERIE 60/90 SINISTRA

- EN** Head 2 sides S60/90 left
- DE** Abschluss element seiten S60/90 links
- FR** Element de jonction 2 cotés S60/90 gauche
- ES** **EMBELLECEDOR 2 LADOS S60/90 IZQUIERDA**

cm. 0,2 x 150

 cm. 200 x 3 x 100h / kg 16 / m³ 0,060

€ 592,00

TMA-69DX

06546900



TESTATA 2 LATI SERIE 60/90 DESTRA

- EN** Head 2 sides S60/90 right
- DE** Abschluss element seiten S60/90 recht
- FR** Element de jonction 2 cotés S60/90 droit
- ES** **EMBELLECEDOR 2 LADOS S60/90 DERECHA**

- cm. 0,2 x 150
- cm. 200 x 3 x 100h / kg 16 / m³ 0,060

€ 592,00
SA-62

06600200



SCHIENA POSTERIORE A VISTA PER APPARECCHI

- EN** Back cover
- DE** Ruckenwand
- FR** Dos de finition
- ES** **PANEL POSTERIOR**

- cm. 20 x 1,5 x 97h
- cm. 22 x 3 x 99h / kg 2 / m³ 0,007

€ 116,00
SA-63

06600300

- cm. 30 x 1,5 x 97h
- cm. 32 x 3 x 99h / kg 3 / m³ 0,010

€ 132,00
SA-64

06600400

- cm. 40 x 1,5 x 97h
- cm. 42 x 3 x 99h / kg 3 / m³ 0,012

€ 150,00
SA-66

06600600

- cm. 60 x 1,5 x 97h
- cm. 62 x 3 x 99h / kg 4 / m³ 0,018

€ 218,00
SA-68

06600800

- cm. 80 x 1,5 x 97h
- cm. 82 x 3 x 99h / kg 5 / m³ 0,024

€ 255,00
SA-610

06601000

- cm. 100 x 1,5 x 97h
- cm. 102 x 3 x 99h / kg 6 / m³ 0,030

€ 318,00
SA-612

06601200

- cm. 120 x 1,5 x 97h
- cm. 122 x 3 x 99h / kg 7 / m³ 0,036

€ 382,00

SA-63FG

06600301

SCHIENA POSTERIORE A VISTA PER FRIGGITRICI GAS

€ 139,00

- EN** Back cover for Gas Fryer
- DE** Rückenwand für Gas-Friteuse
- FR** Dos de finition pour Friteuse a gaz
- ES** **PANEL POSTERIOR PARA FREIDORAS A GAS**

- cm. 30 x 1,5 x 106h
- cm. 32 x 3 x 108h / kg 3 / m³ 0,010

SA-66FG

06600601

cm. 60 x 1,5 x 106h

€ 232,00

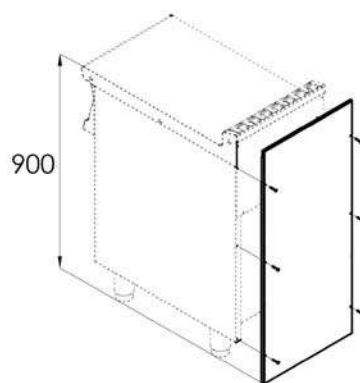
 cm. 62 x 3 x 108h / kg 4 / m³ 0,020**KIT-TOPM-SA**

08600001

KIT TAMPONAMENTI LATERALI PER SCHIENA POSTERIORE MONTATA SU APPARECCHI TOP E MOBILI "M-."

€ 103,00

- EN** Side KIT for back cover mounted on the TOP machine and Stand "M-."
- DE** Seitliches KIT für Rückenwand montiert auf der TOP-Maschine und Unterbau "M-."
- FR** KIT latéral pour Dos de finition monté sur la machine TOP et Placard "M-."
- ES** **KIT LATERAL PARA PANEL POSTERIORE MONTADO EN LA MÁQUINA TOP Y MUEBLE BASE "M-."**

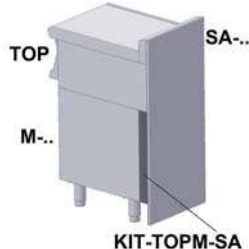
 cm. 50 x 10 x 10h / kg 1 / m³ 0,005**ACCESSORI CUOCIPASTA****EN** PASTA COOKERS ACCESSORIES **DE** ZUBEHÖR NUDELKOCHER **FR** ACCESSOIRES CUISEURS DE PÂTES **ES** **ACCESSORIOS CUECEPASTAS****531017900**

CESTO 1/3 PER CP-66

€ 149,00

- EN** Basket 1/3 for CP-66
- DE** Korb 1/3 für CP-66
- FR** Panier 1/3 pour CP-66
- ES** **CESTA 1/3 PARA CP-66**

- cm. 16 x 29 x 20h
- cm. 26 x 54 x 35h / kg 1,5 / m³ 0,049

**531064300**

CESTO 1/4 PER CP-66

€ 134,00

- EN** Basket 1/4 for CP-66
- DE** Korb 1/4 für CP-66
- FR** Panier 1/4 pour CP-66
- ES** **CESTA 1/4 PARA CP-66**

- cm. 11,5 x 29 x 20h
- cm. 22 x 54 x 35h / kg 1,2 / m³ 0,042



531053900

CESTO 1/1 PER CP-66
EN Basket 1/1 for CP-66
DE Korb 1/1 für CP-66
FR Panier 1/1 pour CP-66
ES **CESTA 1/1 PARA CP-66**
 ↳ cm. 49 x 29 x 20h
 📦 cm. 59 x 39 x 35h / kg 3,5 / m³ 0,081

€ 203,00
531018800

CESTO 1/2 PER CPT-64 - 1/3 PER CPT-66
EN Basket 1/2 for CPT-64 - 1/3 for CPT-66
DE Korb 1/2 für CPT-64 - 1/3 für CPT-66
FR Panier 1/2 pour CPT-64 - 1/3 pour CPT-66
ES **CESTA 1/2 PARA CPT-64 - 1/3 PARA CPT-66**
 ↳ cm. 14,5 x 29 x 15h
 📦 cm. 25 x 54 x 30h / kg 1,3 / m³ 0,041

€ 143,00
531053800

CESTO 1/4 PER CPT-66
EN Basket 1/4 for CPT-66
DE Korb 1/4 für CPT-66
FR Panier 1/4 pour CPT-66
ES **CESTA 1/4 PARA CPT-66**
 ↳ cm. 11,5 x 29 x 15h
 📦 cm. 22 x 54 x 30h / kg 1,2 / m³ 0,036

€ 136,00
531040000

CESTO 1/1 PER CPT-66
EN Basket 1/1 for CPT-66
DE Korb 1/1 für CPT-66
FR Panier 1/1 pour CPT-66
ES **CESTA 1/1 PARA CPT-66**
 ↳ cm. 49 x 29 x 15h
 📦 cm. 59 x 39 x 30h / kg 3,5 / m³ 0,069

€ 245,00
531048900

CESTO 1/6 PER CPT-64
EN Basket 1/6 for CPT-64
DE Korb 1/6 für CPT-64
FR Panier 1/6 pour CPT-64
ES **CESTA 1/6 PARA CPT-64**
 ↳ cm. 14 x 10 x 15h
 📦 cm. 24 x 20 x 30h / kg 1 / m³ 0,014

€ 89,00
531053700

CESTO 1/4 PER CPT-64 - 1/6 PER CPT-66
EN Basket 1/4 for CPT-64 - 1/6 for CPT-66
DE Korb 1/4 für CPT-64 - 1/6 für CPT-66
FR Panier 1/4 pour CPT-64 - 1/6 pour CPT-66
ES **CESTA 1/4 PARA CPT-64 - 1/6 PARA CPT-66**
 ↳ cm. 14 x 16 x 15h
 📦 cm. 24 x 26 x 30h / kg 1 / m³ 0,019

€ 96,00

531053500

CESTO 1/1 PER CPT-64

- EN** Basket 1/1 for CPT-64
- DE** Korb 1/1 für CPT-64
- FR** Panier 1/1 pour CPT-64
- ES** **CESTA 1/1 PARA CPT-64**

cm. 29 x 29 x 15h

 cm. 39 x 39 x 30h / kg 1,5 / m³ 0,046
€ 176,00**531071300**

CESTO CON GANCIO 1/2 PER CPT-64 - 1/3 PER CPT-66

- EN** Basket with hook 1/2 for CPT-64 - 1/3 for CPT-66
- DE** Korb mit Haken 1/2 für CPT-64 - 1/3 für CPT-66
- FR** Panier avec crochet 1/2 pour CPT-64 - 1/3 pour CPT-66
- ES** **CESTA CON GANCHO 1/2 PARA CPT-64 - 1/3 PARA CPT-66**

cm. 13,5 x 25,5 x 15h

 cm. 24 x 51 x 30h / kg 1,3 / m³ 0,037
€ 141,00**531071400**

CESTO CON GANCIO 1/4 PER CPT-66

- EN** Basket with hook 1/4 for CPT-66
- DE** Korb mit Haken 1/4 für CPT-66
- FR** Panier avec crochet 1/4 pour CPT-66
- ES** **CESTA CON GANCHO 1/4 PARA CPT-66**

cm. 11 x 25,5 x 15h

 cm. 21 x 51 x 30h / kg 1,2 / m³ 0,032
€ 134,00**531071200**

CESTO CON GANCIO 1/3 PER CP-66

- EN** Basket with hook 1/3 for CP-66
- DE** Korb mit Haken 1/3 für CP-66
- FR** Panier avec crochet 1/3 pour CP-66
- ES** **CESTA CON GANCHO 1/3 PARA CP-66**

cm. 15 x 26 x 20h

 cm. 25 x 51 x 35h / kg 1,5 / m³ 0,045
€ 162,00**531018700**

CESTO CON GANCIO 1/4 PER CP-66

- EN** Basket with hook 1/4 for CP-66
- DE** Korb mit Haken 1/4 für CP-66
- FR** Panier avec crochet 1/4 pour CP-66
- ES** **CESTA CON GANCHO 1/4 PARA CP-66**

cm. 11 x 26 x 20h

 cm. 21 x 51 x 35h / kg 1,2 / m³ 0,037
€ 135,00

531069400

GRIGLIA SUPPORTO CESTI CON GANCIO PER CP-66

EN support for baskets with hook for CP-66
DE Unterstützung für Körbe mit Haken für CP-66
FR soutien pour les paniers avec crochet pour CP-66
ES **SOPORTE PARA CESTAS CON GANCHO PARA CP-66**

cm. 50 x 29 x 41h
 cm. 55 x 34 x 46h / kg 4 / m³ 0,086

€ 201,00
531071800

GRIGLIA SUPPORTO CESTI CON GANCIO PER CPT-64

EN support for baskets with hook for CPT-64
DE Unterstützung für Körbe mit Haken für CPT-64
FR soutien pour les paniers avec crochet pour CPT-64
ES **SOPORTE PARA CESTAS CON GANCHO PARA CPT-64**

cm. 30 x 33 x 25h
 cm. 35 x 38 x 30h / kg 3 / m³ 0,040

€ 143,00
531071900

GRIGLIA SUPPORTO CESTI CON GANCIO PER CPT-66

EN support for baskets with hook for CPT-66
DE Unterstützung für Körbe mit Haken für CPT-66
FR soutien pour les paniers avec crochet pour CPT-66
ES **SOPORTE PARA CESTAS CON GANCHO PARA CPT-66**

cm. 50 x 30 x 25h
 cm. 55 x 35 x 30h / kg 3,5 / m³ 0,058

€ 185,00
ACCESSORI FRY-TOP
EN GRIDDLE ACCESSORIES **DE** ZUBEHÖR GRIDDLEPLATTEN **FR** ACCESSOIRES FRY-TOP **ES** ACCESORIOS FRY-TOP

544023800

RASCHIETTO PER PIASTRA RIGATA

EN Scraper for grooved plate
DE Schaber für gerillte Kochplatte
FR Racloir pour plaque nervurée
ES **RASQUETA PARA PLACA RANURADA**

cm. 20 x 7 x 3h / kg 0.5 / m³ 0,001

€ 71,00
531040800

RASCHIETTO PER PIASTRA LISCIA AL CROMO LUCIDO

EN Scraper for smooth POLISHED CHROME plate
DE Schaber für glatte POLIERTEM CHROM Platte
FR Racloir pour plaque lisse au CHROME POLI
ES **RASQUETA PARA PLACA LISA DE CROMO PULIDO**

cm. 20 x 7 x 3h / kg 0.5 / m³ 0,001

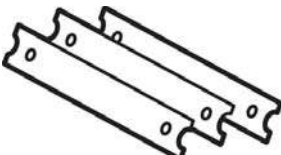
€ 65,00
531040900

KIT 10 LAME PER RASCHIETTO COD.531040800

EN 10 blades kit for scraper cod.531040800
DE Kit 10 klingen für Schaber cod.531040800
FR Kit de 10 lames pour racloir cod.531040800
ES **KIT DE 10 CUCHILLAS PARA RASQUETA COD.531040800**

cm. 10 x 10 x 5h / kg 0.5 / m³ 0,001

€ 46,00

T-FT

09580060



TAPPO PER FRY-TOP

- EN** stopper for Fry-top
- DE** Stopfen griddleplatte
- FR** bouchon pour Plaque
- ES** **TAPÓN FRY-TOP**

- cm. 10 x 2 x 5h
- cm. 20 x 20 x 10h / kg 0.5 / m³ 0,004

€ 275,00

PFT-64

06620400



KIT PROTEZIONE FRONTALE PIANO FRY-TOP

- EN** KIT front protection plan fry-top
- DE** Schutz-kit vorne Plan griddleplatte
- FR** KIT protection avant plan plaque
- ES** **KIT DE PROTECCIÓN FRONTAL PLAN DE FRY-TOP**

- cm. 38 x 8 x 6h
- cm. 41 x 11 x 9h / kg 2 / m³ 0,004

€ 141,00

PFT-66

06620600

- cm. 58 x 8 x 6h
- cm. 61 x 11 x 9h / kg 3 / m³ 0,006

€ 191,00

PFT-68

06620800

- cm. 78 x 8 x 6h
- cm. 81 x 11 x 9h / kg 4 / m³ 0,008

€ 240,00

PFT-610

06621000

- cm. 98 x 8 x 6h
- cm. 101 x 11 x 9h / kg 5 / m³ 0,010

€ 272,00

ACCESSORI GRIGLIE

EN GRILL ACCESSORIES **DE** ZUBEHÖR GRILLS **FR** ACCESSOIRES CHARCOAL **ES** ACCESORIOS BARBACOAS
06570401

GRIGLIA TONDINO PER CW64 (SERIE 60)

- EN** Grid for CW-64 (60 line)
- DE** Gitter für CW-64 (60. Serie)
- FR** Grille ronde pour CW-64 (serie 60)
- ES** **REJILLA PARA CW-64 (SERIE 60)**

- cm. 38 x 42
- cm. 42 x 55 x 10h / kg 9 / m³ 0,023

€ 422,00

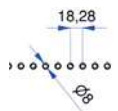
**06570601**

GRIGLIA TONDINO PER CW66 (SERIE 60)

- EN** Grid for CW-66 (60 line)
- DE** Gitter für CW-66 (60. Serie)
- FR** Grille ronde pour CW-66 (serie 60)
- ES** **REJILLA PARA CW-66 (SERIE 60)**

- cm. 58 x 42
- cm. 62 x 55 x 10h / kg 9 / m³ 0,034

€ 602,00

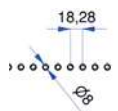
**06570402**

GRIGLIA TEGOLO V PER CW-64 (SERIE 60)

- EN** V TRAY for CW-64 (60 LINE)
- DE** V ROSTE FÜR CW-64 (60 LINIE)
- FR** V GRILLE POUR CW-64 (LIGNE 60)
- ES** **V REJILLA PARA CW-64 (SERIE 60)**

- cm. 36 x 43
- cm. 42 x 55 x 10h / kg 9 / m³ 0,023

€ 288,00

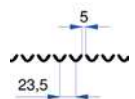
**06570602**

GRIGLIA TEGOLO V PER CW-66 (SERIE 60)

- EN** V TRAY for CW-66 (60 LINE)
- DE** V ROSTE FÜR CW-66 (60 LINIE)
- FR** V GRILLE POUR CW-66 (LIGNE 60)
- ES** **V REJILLA PARA CW-66 (SERIE 60)**

- cm. 56 x 43
- cm. 62 x 55 x 10h / kg 9 / m³ 0,034

€ 416,00

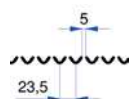

ACCESSORI FRIGGITRICI
EN FRYERS ACCESSORIES **DE** ZUBEHÖR FRITEUSE **FR** ACCESSOIRES FRITEUSE **ES** ACCESORIOS FREIDORAS

531013200

CESTO 1/2 PER F13-64E / F10T-63E

EN Basket 1/2 for F13-64E / F10T-63E

DE Korb 1/2 für F13-64E / F10T-63E

FR Panier 1/2 pour F13-64E / F10T-63E

ES CESTA 1/2 PARA F13-64E / F10T-63E

cm. 10 x 30 x 12h

 cm. 20 x 55 x 27h / kg 0.7 / m³ 0,030

€ 65,00
531053300

CESTO 1/2 PER F13-64G

EN Basket 1/2 for F13-64G

DE Korb 1/2 für F13-64G

FR Panier 1/2 pour F13-64G

ES CESTA 1/2 PARA F13-64G

cm. 15 x 27 x 12h

 cm. 25 x 52 x 27h / kg 0.7 / m³ 0,035

€ 87,00
ACCESSORI BRASIERE
EN BRATTPANS ACCESSORIES **DE** ZUBEHÖR KIPPBRATPFANNEN **FR** ACCESSOIRES SAUTEUSES **ES** ACCESORIOS SARTENS

06550600

COPERCHIO BRT-66

EN Lid BRT-66

DE Deckel BRT-66

FR Couvercle BRT-66

ES TAPA BRT-66

cm. 51 x 42 x 3h

 cm. 53 x 44 x 8h / kg 5 / m³ 0,019

€ 156,00
ACCESSORI BASE CON FORNO
EN STAND WITH OVEN ACCESSORIES **DE** ZUBEHÖR UNTERBAU MIT OFEN **FR** ACCESSOIRES PALCARD AVEC FOUR **ES** ACCESORIOS MUEBLE CON HORNO

CMF-68

06490800



COPERCHIO PER MFM-68E

EN Lid for MFM-68E

DE Berichterstattung für MFM-68E

FR Couvercle pour MFM-68E

ES CUBERTURA PARA MFM-68E

cm. 80 x 54 x 2,8h

 cm. 83 x 57 x 5h / kg 4 / m³ 0,024

€ 230,00
CMF-610

06491000

COPERCHIO PER MFM-610E

EN Lid for MFM-610E

DE Berichterstattung für MFM-610E

FR Couvercle pour MFM-610E

ES CUBERTURA PARA MFM-610E

cm. 100 x 54 x 2,8h

 cm. 103 x 57 x 5h / kg 5 / m³ 0,029

€ 296,00