

70 SUPERLOTUS



70 SUPERLOTUS

CUCINE ELETTRICHE
EN ELECTRIC COOKERS DE ELEKTRO HERDE FR FOURNEAU ÉLECTRIQUE ES COCINA ELECTRICAS
CF4-78ET
08660830

CUCINA 4 PIASTRE - FORNO ELETTRICO STATICO CM. 67X55X34H, TEMP: 50÷300°C, CON 1 GRIGLIA CM.65X53 GN2/1 (INCLUSA 1 TESTATA CHIUSURA PIANO MOD.TPA-7)

- EN** Electric range - N. 4 plates Traditional electric oven cm. 67x55x34h, temp: 50÷300°C, with 1 grid cm.65x53 GN2/1 (included 1 Head end filler strip mod.TPA-7)
- DE** Elektroherd - N. 4 Kochplatten Statischer Elektro-Backofen cm. 67x55x34h, temp: 50÷300°C, mit 1 Rost cm.65x53 GN2/1 (inbegriffen 1 Abschluss-Element mod.TPA-7)
- FR** Fourneau électrique - N. 4 plaques Four électrique statique cm. 67x55x34h, temp: 50÷300°C avec 1 grille cm.65x53 GN2/1 (inclus 1 Elément de jonction top mod.TPA-7)
- ES** **COCINA ELÉCTRICA - N. 4 PLANCHAS HORNO ELÉCTRICO ESTÁTICO CM. 67X55X34H, TEMP: 50÷300°C, CON 1 PARILLA CM.65X53 GN2/1 (INCLUIDA 1 CHAPA DE CIERRE PARA TOP MOD.TPA-7)**

- cm. 80 x 70,5 x 90h
- cm. 83 x 77 x 111h / kg 112 / m³ 0,709

 15,4 kW
400V~3N
50/60 Hz

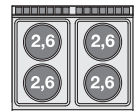
€ 4.095,00

CFV4-78ET
08800830

CUCINA 4 PIASTRE - FORNO ELETTRICO MULTIFUNZIONE CM. 55X37X34H, TEMP: 50÷260°C, CON 1 GRIGLIA CM.53X32,5 GN1/1 - PORTA INOX (INCLUSA 1 TESTATA CHIUSURA PIANO MOD.TPA-7)

- EN** Electric range - N. 4 plates - Multifunction electric oven cm. 55x37x34h, temp: 50÷260°C, with 1 grid cm.53x32,5 GN1/1 - Stainless steel door (included 1 Head end filler strip mod.TPA-7)
- DE** Elektroherd - N. 4 Kochplatten - Multifunktions-Elektroofen cm. 55x37x34h, temp: 50÷260°C, mit 1 Rost cm.53x32,5 GN1/1 - Edelstahltür (inbegriffen 1 Abschluss-Element mod.TPA-7)
- FR** Fourneau électrique - N. 4 plaques Four électrique à fonctions multiples cm. 55x37x34h, temp: 50÷260°C avec 1 grille cm.53x32,5 GN1/1 - Porte acier inoxydable (inclus 1 Elément de jonction top mod.TPA-7)
- ES** **COCINA ELÉCTRICA - N. 4 PLANCHAS - HORNO ELÉCTRICO MULTIFUNCIONAL CM. 55X37X34H, TEMP: 50÷250°C, CON 1 PARILLA CM.53X32,5 GN1/1 - PUERTA INOX (INCLUIDA 1 CHAPA DE CIERRE PARA TOP MOD.TPA-7)**

- cm. 80 x 70,5 x 90h
- cm. 83 x 77 x 111h / kg 112 / m³ 0,709

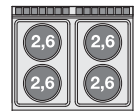
 15,4 kW
400V~3N
50/60 Hz

€ 4.715,00

CFV4-78ET/V
0880083A

CUCINA 4 PIASTRE - FORNO ELETTRICO MULTIFUNZIONE CM. 55X37X34H, TEMP: 50÷260°C, CON 1 GRIGLIA CM.53X32,5 GN1/1 - PORTA VETRO (INCLUSA 1 TESTATA CHIUSURA PIANO MOD.TPA-7)

- EN** Electric range - N. 4 plates - Multifunction electric oven cm. 55x37x34h, temp: 50÷260°C, with 1 grid cm.53x32,5 GN1/1 - Glass door (included 1 Head end filler strip mod.TPA-7)
- DE** Elektroherd - N. 4 Kochplatten - Multifunktions-Elektroofen cm. 55x37x34h, temp: 50÷260°C, mit 1 Rost cm.53x32,5 GN1/1 - Glastür (inbegriffen 1 Abschluss-Element mod.TPA-7)
- FR** Fourneau électrique - N. 4 plaques Four électrique à fonctions multiples cm. 55x37x34h, temp: 50÷260°C avec 1 grille cm.53x32,5 GN1/1 - Porte vitrée (inclus 1 Elément de jonction top mod.TPA-7)
- ES** **COCINA ELÉCTRICA - N. 4 PLANCHAS - HORNO ELÉCTRICO MULTIFUNCIONAL CM. 55X37X34H, TEMP: 50÷250°C, CON 1 PARILLA CM.53X32,5 GN1/1 - PUERTA VIDRIO (INCLUIDA 1 CHAPA DE CIERRE PARA TOP MOD.TPA-7)**

- cm. 80 x 70,5 x 90h
- cm. 83 x 77 x 111h / kg 112 / m³ 0,709

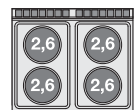
 15,4 kW
400V~3N
50/60 Hz

€ 4.866,00

CFQ4-78ET
08660831

CUCINA 4 PIASTRE QUADRE - FORNO ELETTRICO STATICO CM. 67X55X34H, TEMP: 50÷300°C, CON 1 GRIGLIA CM.65X53 GN2/1 (INCLUSA 1 TESTATA CHIUSURA PIANO MOD. TPA-7)

- EN** Electric range - N. 4 square plates Traditional electric oven cm. 67x55x34h, temp: 50÷300°C, with 1 grid cm.65x53 GN2/1 (included 1 Head end filler strip mod.TPA-7)
- DE** Elektroherd - N. 4 quadratischen Platten - Statischer Elektro-Backofen cm. 67x55x34h, temp: 50÷300°C, mit 1 Rost cm.65x53 GN2/1 (inbegriffen 1 Abschluss-Element mod.TPA-7)
- FR** Fourneau électrique - N. 4 plaques carrés - Four électrique statique cm. 67x55x34h, temp: 50÷300°C avec 1 grille cm.65x53 GN2/1 (inclus 1 Elément de jonction top mod.TPA-7)
- ES** **COCINA ELÉCTRICA - N. 4 PLANCHAS CUADRADAS HORNO ELÉCTRICO ESTÁTICO CM. 67X55X34H, TEMP: 50÷300°C, CON 1 PARILLA CM.65X53 GN2/1 (INCLUIDA 1 CHAPA DE CIERRE PARA TOP MOD.TPA-7)**

- cm. 80 x 70,5 x 90h
- cm. 83 x 77 x 111h / kg 120 / m³ 0,709

 15,4 kW
400V~3N
50/60 Hz

€ 5.293,00

CFVQ4-78ET

08800831



CUCINA 4 PIASTRE QUADRE - FORNO ELETTRICO MULTIFUNZIONE CM. 55X37X34H, TEMP: 50÷260°C, CON 1 GRIGLIA CM.53X32,5 GN1/1 - PORTA INOX (INCLUSA 1 TESTATA CHIUSURA PIANO MOD.TPA-7)

EN Electric range - N. 4 square plates - Multifunction electric oven cm. 55x37x34h, temp: 50÷260°C, with 1 grid cm.53x32,5 GN1/1 - Stainless steel door (included 1 Head end filler strip mod.TPA-7)

DE Elektroherd - N. 4 quadratischen Platten - Multifunktions-Elektroofen cm. 55x37x34h, temp: 50÷260°C, mit 1 Rost cm.53x32,5 GN1/1 - Edelstahltür (inbegriffen 1 Abschluss-Element mod.TPA-7)

FR Fourneau électrique - N. 4 plaques carrés - Four électrique à fonctions multiples cm. 55x37x34h, temp: 50÷260°C avec 1 grille cm.53x32,5 GN1/1 - Porte acier inoxydable (inclus 1 Élément de jonction top mod.TPA-7)

ES **COCINA ELÉCTRICA - N. 4 PLANCHAS CUADRADAS HORNO ELÉCTRICO MULTIFUNCIONAL CM. 55X37X34H, TEMP: 50÷250°C, CON 1 PARILLA CM.53X32,5 GN1/1 - PUERTA INOX (INCLUIDA 1 CHAPA DE CIERRE PARA TOP MOD.TPA-7)**

cm. 80 x 70,5 x 90h

cm. 83 x 77 x 111h / kg 120 / m³ 0,709

15,4 kW
400V~3N
50/60 Hz

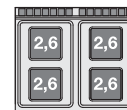
€ 5.875,00**CFVQ4-78ET/V**

0880083B



CUCINA 4 PIASTRE QUADRE - FORNO ELETTRICO MULTIFUNZIONE CM. 55X37X34H, TEMP: 50÷260°C, CON 1 GRIGLIA CM.53X32,5 GN1/1 - PORTA VETRO (INCLUSA 1 TESTATA CHIUSURA PIANO MOD.TPA-7)

EN Electric range - N. 4 square plates - Multifunction electric oven cm. 55x37x34h, temp: 50÷260°C, with 1 grid cm.53x32,5 GN1/1 - Glass door (included 1 Head end filler strip mod.TPA-7)

DE Elektroherd - N. 4 quadratischen Platten - Multifunktions-Elektroofen cm. 55x37x34h, temp: 50÷260°C, mit 1 Rost cm.53x32,5 GN1/1 - Glastür (inbegriffen 1 Abschluss-Element mod.TPA-7)

FR Fourneau électrique - N. 4 plaques carrés - Four électrique à fonctions multiples cm. 55x37x34h, temp: 50÷260°C avec 1 grille cm.53x32,5 GN1/1 - Porte vitrée (inclus 1 Élément de jonction top mod.TPA-7)

ES **COCINA ELÉCTRICA - N. 4 PLANCHAS CUADRADAS HORNO ELÉCTRICO MULTIFUNCIONAL CM. 55X37X34H, TEMP: 50÷250°C, CON 1 PARILLA CM.53X32,5 GN1/1 - PUERTA VIDRIO (INCLUIDA 1 CHAPA DE CIERRE PARA TOP MOD.TPA-7)**

cm. 80 x 70,5 x 90h

cm. 83 x 77 x 111h / kg 120 / m³ 0,709

15,4 kW
400V~3N
50/60 Hz

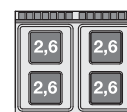
€ 6.026,00**CFC4-78ET**

08660832



CUCINA 4 PIASTRE VETROCERAMICA CM. 75 X 57 - FORNO ELETTRICO STATICO CM. 67X55X34H, TEMP: 50÷300°C, CON 1 GRIGLIA CM.65X53 GN2/1 (INCLUSA 1 TESTATA CHIUSURA PIANO MOD.TPA-7)

EN Electric range N. 4 plates ceramic glass cm. 75 x 57 - traditional electric oven cm. 67x55x34h, temp: 50÷300°C, with 1 grid cm.65x53 GN2/1 (included 1 Head end filler strip mod.TPA-7)

DE Elektroherd N. 4 Ceran-Kochplatten cm. 75 x 57 - Statischer Elektro-Backofen cm. 67x55x34h, temp: 50÷300°C, mit 1 Rost cm.65x53 GN2/1 (inbegriffen 1 Abschluss-Element mod.TPA-7)

FR Fourneau électrique N. 4 plaques vitroceramique cm. 75 x 57 - Four électrique statique cm. 67x55x34h, temp: 50÷300°C avec 1 grille cm.65x53 GN2/1 (inclus 1 Élément de jonction top mod.TPA-7)

ES **COCINA ELÉCTRICA N. 4 PLANCHAS VITROCERÁMICA CM. 75 X 57 - HORNO ELÉCTRICO ESTÁTICO CM. 67X55X34H, TEMP: 50÷300°C, CON 1 PARILLA CM.65X53 GN2/1 (INCLUIDA 1 CHAPA DE CIERRE PARA TOP MOD.TPA-7)**

cm. 80 x 70,5 x 90h

cm. 83 x 77 x 111h / kg 107 / m³ 0,709

15 kW
400V~3N
50/60 Hz

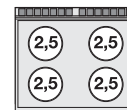
€ 5.832,00**CFVC4-78ET**

08800832



CUCINA 4 PIASTRE VETROCERAMICA CM. 75 X 57 - FORNO ELETTRICO MULTIFUNZIONE CM. 55X37X34H, TEMP: 50÷260°C, CON 1 GRIGLIA CM.53X32,5 GN1/1 - PORTA INOX (INCLUSA 1 TESTATA CHIUSURA PIANO MOD.TPA-7)

EN Electric range N. 4 plates ceramic glass cm. 75 x 57 - Multifunction electric oven cm. 55x37x34h, temp: 50÷260°C, with 1 grid cm.53x32,5 GN1/1 - Stainless steel door (included 1 Head end filler strip mod.TPA-7)

DE Elektroherd N. 4 Ceran-Kochplatten cm. 75 x 57 - Multifunktions-Elektroofen cm. 55x37x34h, temp: 50÷260°C, mit 1 Rost cm.53x32,5 GN1/1 - Edelstahltür (inbegriffen 1 Abschluss-Element mod.TPA-7)

FR Fourneau électrique N. 4 plaques vitroceramique cm. 75 x 57 - Four électrique à fonctions multiples cm. 55x37x34h, temp: 50÷260°C avec 1 grille cm.53x32,5 GN1/1 - Porte acier inoxydable (inclus 1 Élément de jonction top mod.TPA-7)

ES **COCINA ELÉCTRICA N. 4 PLANCHAS VITROCERÁMICA CM. 75 X 57 - HORNO ELÉCTRICO MULTIFUNCIONAL CM. 55X37X34H, TEMP: 50÷250°C, CON 1 PARILLA CM.53X32,5 GN1/1 - PUERTA INOX (INCLUIDA 1 CHAPA DE CIERRE PARA TOP MOD.TPA-7)**

cm. 80 x 70,5 x 90h

cm. 83 x 77 x 111h / kg 107 / m³ 0,709

15 kW
400V~3N
50/60 Hz

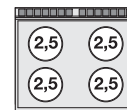
€ 6.367,00

CFVC4-78ET/V
 0880083C

CUCINA 4 PIASTRE VETROCERAMICA CM. 75 X 57 - FORNO ELETTRICO MULTIFUNZIONE CM. 55X37X34H, TEMP: 50÷260°C, CON 1 GRIGLIA CM.53X32,5 GN1/1 - PORTA VETRO (INCLUSA 1 TESTATA CHIUSURA PIANO MOD.TPA-7)

- EN** Electric range N. 4 plates ceramic glass cm. 75 x 57 - Multifunction electric oven cm. 55x37x34h, temp: 50÷260°C, with 1 grid cm.53x32,5 GN1/1 - Glass door (included 1 Head end filler strip mod.TPA-7)
- DE** Elektroherd N. 4 Ceran-Kochplatten cm. 75 x 57 - Multifunktions-Elektroofen cm. 55x37x34h, temp: 50÷260°C, mit 1 Rost cm.53x32,5 GN1/1 - Glastür (inbegriffen 1 Abschluss-Element mod.TPA-7)
- FR** Fourneau électrique N. 4 plaques vitroceramique cm. 75 x 57 - Four électrique à fonctions multiples cm. 55x37x34h, temp: 50÷260°C avec 1 grille cm.53x32,5 GN1/1 - Porte vitrée (inclus 1 Élément de jonction top mod.TPA-7)
- ES** **COCINA ELÉCTRICA N. 4 PLANCHAS VITROCERÁMICA CM. 75 X 57 - HORNO ELÉCTRICO MULTIFUNCIONAL CM. 55X37X34H, TEMP: 50÷250°C, CON 1 PARILLA CM.53X32,5 GN1/1 - PUERTA VIDRIO (INCLUIDA 1 CHAPA DE CIERRE PARA TOP MOD.TPA-7)**

cm. 80 x 70,5 x 90h
 cm. 83 x 77 x 111h / kg 107 / m³ 0,709

⚡ 15 kW
 400V~3N
 50/60 Hz

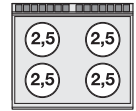
€ 6.518,00

CF6-712ETV
 08661230

CUCINA 6 PIASTRE - FORNO ELETTRICO STATICO CM. 67X55X34H, TEMP: 50÷300°C, CON 1 GRIGLIA CM.65X53 GN2/1 - VANO NEUTRO CON PORTA (INCLUSA 1 TESTATA CHIUSURA PIANO MOD.TPA-7)

- EN** Electric range - N. 6 plates Traditional electric oven cm. 67x55x34h, temp: 50÷300°C, with 1 grid cm.65x53 GN2/1 - Neutral cabinet with door (included 1 Head end filler strip mod.TPA-7)
- DE** Elektroherd - N. 6 Kochplatten Statischer Elektro-Backofen cm. 67x55x34h, temp: 50÷300°C, mit 1 Rost cm.65x53 GN2/1 - Neutrales Schrankelement mit Tür (inbegriffen 1 Abschluss-Element mod.TPA-7)
- FR** Fourneau électrique - N. 6 plaques Four électrique statique cm. 67x55x34h, temp: 50÷300°C avec 1 grille cm.65x53 GN2/1 - Element neutre avec porte (inclus 1 Élément de jonction top mod.TPA-7)
- ES** **COCINA ELÉCTRICA - N. 6 PLANCHAS HORNO ELÉCTRICO ESTÁTICO CM. 67X55X34H, TEMP: 50÷300°C, CON 1 PARILLA CM.65X53 GN2/1 - ARMARIO NEUTRO CON PUERTA (INCLUIDA 1 CHAPA DE CIERRE PARA TOP MOD.TPA-7)**

cm. 120 x 70,5 x 90h
 cm. 123 x 77 x 111h / kg 134 / m³ 1,051

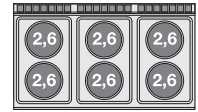
⚡ 20,6 kW
 400V~3N
 50/60 Hz

€ 5.433,00

CFV6-712ETV
 08801230

CUCINA 6 PIASTRE - FORNO ELETTRICO MULTIFUNZIONE CM. 55X37X34H, TEMP: 50÷260°C, CON 1 GRIGLIA CM.53X32,5 GN1/1 - PORTA INOX - VANO NEUTRO CON PORTA (INCLUSA 1 TESTATA CHIUSURA PIANO MOD.TPA-7)

- EN** Electric range - N. 6 plates Multifunction electric oven cm. 55x37x34h, temp: 50÷260°C, with 1 grid cm.53x32,5 GN1/1 - Stainless steel door - Neutral cabinet with door (included 1 Head end filler strip mod.TPA-7)
- DE** Elektroherd - N. 6 Kochplatten Multifunktions-Elektroofen cm. 55x37x34h, temp: 50÷260°C, mit 1 Rost cm.53x32,5 GN1/1 - Edelstahltür - Neutrales Schrankelement mit Tür (inbegriffen 1 Abschluss-Element mod.TPA-7)
- FR** Fourneau électrique - N. 6 plaques Four électrique à fonctions multiples cm. 55x37x34h, temp: 50÷260°C avec 1 grille cm.53x32,5 GN1/1 - Porte acier inoxydable - Element neutre avec porte (inclus 1 Élément de jonction top mod.TPA-7)
- ES** **COCINA ELÉCTRICA - N. 6 PLANCHAS HORNO ELÉCTRICO MULTIFUNCIONAL CM. 55X37X34H, TEMP: 50÷250°C, CON 1 PARILLA CM.53X32,5 GN1/1 - PUERTA INOX - ARMARIO NEUTRO CON PUERTA (INCLUIDA 1 CHAPA DE CIERRE PARA TOP MOD.TPA-7)**

cm. 120 x 70,5 x 90h
 cm. 123 x 77 x 111h / kg 134 / m³ 1,051

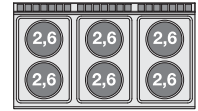
⚡ 20,6 kW
 400V~3N
 50/60 Hz

€ 6.019,00

CFV6-712ETV/V
 0880123A

CUCINA 6 PIASTRE - FORNO ELETTRICO MULTIFUNZIONE CM. 55X37X34H, TEMP: 50÷260°C, CON 1 GRIGLIA CM.53X32,5 GN1/1 - PORTA VETRO - VANO NEUTRO CON PORTA (INCLUSA 1 TESTATA CHIUSURA PIANO MOD.TPA-7)

- EN** Electric range - N. 6 plates Multifunction electric oven cm. 55x37x34h, temp: 50÷260°C, with 1 grid cm.53x32,5 GN1/1 - Glass door - Neutral cabinet with door (included 1 Head end filler strip mod.TPA-7)
- DE** Elektroherd - N. 6 Kochplatten Multifunktions-Elektroofen cm. 55x37x34h, temp: 50÷260°C, mit 1 Rost cm.53x32,5 GN1/1 - Glastür - Neutrales Schrankelement mit Tür (inbegriffen 1 Abschluss-Element mod.TPA-7)
- FR** Fourneau électrique - N. 6 plaques Four électrique à fonctions multiples cm. 55x37x34h, temp: 50÷260°C avec 1 grille cm.53x32,5 GN1/1 - Porte vitrée - Element neutre avec porte (inclus 1 Élément de jonction top mod.TPA-7)
- ES** **COCINA ELÉCTRICA - N. 6 PLANCHAS HORNO ELÉCTRICO MULTIFUNCIONAL CM. 55X37X34H, TEMP: 50÷250°C, CON 1 PARILLA CM.53X32,5 GN1/1 - PUERTA VIDRIO - ARMARIO NEUTRO CON PUERTA (INCLUIDA 1 CHAPA DE CIERRE PARA TOP MOD.TPA-7)**

cm. 120 x 70,5 x 90h
 cm. 123 x 77 x 111h / kg 134 / m³ 1,051

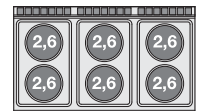
⚡ 20,6 kW
 400V~3N
 50/60 Hz

€ 6.170,00

CFQ6-712ETV

08661231



CUCINA 6 PIASTRE QUADRE - FORNO ELETTRICO STATICO CM. 67X55X34H, TEMP: 50÷300°C, CON 1 GRIGLIA CM.65X53 GN2/1 - VANO NEUTRO CON PORTA (INCLUSA 1 TESTATA CHIUSURA PIANO MOD.TPA-7)

- EN** Electric range - N. 6 square plates Traditional electric oven cm. 67x55x34h, temp: 50÷300°C, with 1 grid cm.65x53 GN2/1 - Neutral cabinet with door (included 1 Head end filler strip mod.TPA-7)
- DE** Elektroherd - N. 6 quadratischen Platten Statischer Elektro-Backofen cm. 67x55x34h, temp: 50÷300°C, mit 1 Rost cm.65x53 GN2/1 - Neutrales Schrankelement mit Tür (inbegriffen 1 Abschluss-Element mod.TPA-7)
- FR** Fourneau électrique - N. 6 plaques carrés Four électrique statique cm. 67x55x34h, temp: 50÷300°C avec 1 grille cm.65x53 GN2/1 - Element neutre avec porte (inclus 1 Elément de jonction top mod.TPA-7)
- ES** **COCINA ELÉCTRICA - N. 6 PLANCHAS CUADRADAS HORNO ELÉCTRICO ESTÁTICO CM. 67X55X34H, TEMP: 50÷300°C, CON 1 PARILLA CM.65X53 GN2/1 - ARMARIO NEUTRO CON PUERTA (INCLUIDA 1 CHAPA DE CIERRE PARA TOP MOD.TPA-7)**

- cm. 120 x 70,5 x 90h
- cm. 123 x 77 x 111h / kg 146 / m³ 1,051

⚡ 20,6 kW
400V~3N
50/60 Hz

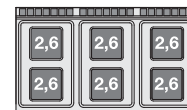
**CFVQ6-712ETV**

08801231



CUCINA 6 PIASTRE QUADRE - FORNO ELETTRICO MULTIFUNZIONE CM. 55X37X34H, TEMP: 50÷260°C, CON 1 GRIGLIA CM.53X32,5 GN1/1 - PORTA INOX - VANO NEUTRO CON PORTA (INCLUSA 1 TESTATA CHIUSURA PIANO MOD.TPA-7)

- EN** Electric range - N. 6 square plates Multifunction electric oven cm. 55x37x34h, temp: 50÷260°C, with 1 grid cm.53x32,5 GN1/1 - Stainless steel door - Neutral cabinet with door (included 1 Head end filler strip mod.TPA-7)
- DE** Elektroherd - N. 6 quadratischen Platten Multifunktions-Elektroofen cm. 55x37x34h, temp: 50÷260°C, mit 1 Rost cm.53x32,5 GN1/1 - Edelstahltür - Neutrales Schrankelement mit Tür (inbegriffen 1 Abschluss-Element mod.TPA-7)
- FR** Fourneau électrique - N. 6 plaques carrés Four électrique à fonctions multiples cm. 55x37x34h, temp: 50÷260°C avec 1 grille cm.53x32,5 GN1/1 - Porte acier inoxydable - Element neutre avec porte (inclus 1 Elément de jonction top mod.TPA-7)
- ES** **COCINA ELÉCTRICA - N. 6 PLANCHAS CUADRADAS HORNO ELÉCTRICO MULTIFUNCIONAL CM. 55X37X34H, TEMP: 50÷250°C, CON 1 PARILLA CM.53X32,5 GN1/1 - PUERTA INOX - ARMARIO NEUTRO CON PUERTA (INCLUIDA 1 CHAPA DE CIERRE PARA TOP MOD.TPA-7)**

- cm. 120 x 70,5 x 90h
- cm. 123 x 77 x 111h / kg 146 / m³ 1,051

⚡ 20,6 kW
400V~3N
50/60 Hz

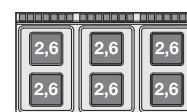
**CFVQ6-712ETV/V**

0880123B



CUCINA 6 PIASTRE QUADRE - FORNO ELETTRICO MULTIFUNZIONE CM. 55X37X34H, TEMP: 50÷260°C, CON 1 GRIGLIA CM.53X32,5 GN1/1 - PORTA VETRO - VANO NEUTRO CON PORTA (INCLUSA 1 TESTATA CHIUSURA PIANO MOD.TPA-7)

- EN** Electric range - N. 6 square plates Multifunction electric oven cm. 55x37x34h, temp: 50÷260°C, with 1 grid cm.53x32,5 GN1/1 - Glass door - Neutral cabinet with door (included 1 Head end filler strip mod.TPA-7)
- DE** Elektroherd - N. 6 quadratischen Platten Multifunktions-Elektroofen cm. 55x37x34h, temp: 50÷260°C, mit 1 Rost cm.53x32,5 GN1/1 - Glastür - Neutrales Schrankelement mit Tür (inbegriffen 1 Abschluss-Element mod.TPA-7)
- FR** Fourneau électrique - N. 6 plaques carrés Four électrique à fonctions multiples cm. 55x37x34h, temp: 50÷260°C avec 1 grille cm.53x32,5 GN1/1 - Porte vitrée - Element neutre avec porte (inclus 1 Elément de jonction top mod.TPA-7)
- ES** **COCINA ELÉCTRICA - N. 6 PLANCHAS CUADRADAS HORNO ELÉCTRICO MULTIFUNCIONAL CM. 55X37X34H, TEMP: 50÷250°C, CON 1 PARILLA CM.53X32,5 GN1/1 - PUERTA VIDRIO - ARMARIO NEUTRO CON PUERTA (INCLUIDA 1 CHAPA DE CIERRE PARA TOP MOD.TPA-7)**

- cm. 120 x 70,5 x 90h
- cm. 123 x 77 x 111h / kg 146 / m³ 1,051

⚡ 20,6 kW
400V~3N
50/60 Hz

**CF6-712ET**

08661232



CUCINA 6 PIASTRE FORNO ELETTRICO STATICO CM. 107X55X34H, TEMP: 50÷300°C, CON 1 GRIGLIA CM.105X53 (INCLUSA 1 TESTATA CHIUSURA PIANO MOD.TPA-7)

- EN** Electric Range - N. 6 plates Traditional electric oven cm. 107x55x34h, temp: 50÷300°C, with 1 grid cm.105x53 (included 1 Head end filler strip mod.TPA-7)
- DE** Elektroherd - N. 6 Kochplatten Statischer Elektro-Backofen cm. 107x55x34h, temp: 50÷300°C, mit 1 Rost cm.105x53 (inbegriffen 1 Abschluss-Element mod.TPA-7)
- FR** Fourneau électrique - N. 6 plaques Four électrique statique cm. 107x55x34h, temp: 50÷300°C, avec 1 grille cm.105x53 (inclus 1 Elément de jonction top mod.TPA-7)
- ES** **COCINA ELÉCTRICA - N. 6 PLANCHAS HORNO ELÉCTRICO ESTÁTICO CM. 107X55X34H, TEMP: 50÷300°C, CON 1 PARILLA CM.105X53 (INCLUIDA 1 CHAPA DE CIERRE PARA TOP MOD.TPA-7)**

- cm. 120 x 70,5 x 90h
- cm. 123 x 77 x 111h / kg 136 / m³ 1,051

⚡ 22,5 kW
400V~3N
50/60 Hz

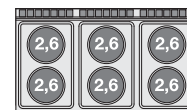

CFQ6-712ET

08661233



CUCINA 6 PIASTRE QUADRE FORNO ELETTRICO STATICO CM. 107X55X34H, TEMP: 50÷300°C, CON 1 GRIGLIA CM.105X53 (INCLUSA 1 TESTATA CHIUSURA PIANO MOD.TPA-7)

EN Electric Range - N. 6 square plates Traditional electric oven cm. 107x55x34h, temp: 50÷300°C, with 1 grid cm.105x53 (included 1 Head end filler strip mod.TPA-7)

DE Elektroherd - N. 6 quadratischen Platten Statischer Elektro-Backofen cm. 107x55x34h, temp: 50÷300°C, mit 1 Rost cm.105x53 (inbegriffen 1 Abschluss-Element mod.TPA-7)

FR Fourneau électrique - N. 6 plaques carrés Four électrique statique cm. 107x55x34h, temp: 50÷300°C, avec 1 grille cm.105x53 (inclus 1 Élément de jonction top mod. TPA-7)

ES **COCINA ELÉCTRICA - N. 6 PLANCHAS CUADRADAS HORNO ELÉCTRICO ESTÁTICO CM. 107X55X34H, TEMP: 50÷300°C, CON 1 PARILLA CM.105X53 (INCLUIDA 1 CHAPA DE CIERRE PARA TOP MOD.TPA-7)**

22,5 kW
400V~3N
50/60 Hz

€ 7.866,00

cm. 120 x 70,5 x 90h
 cm. 123 x 77 x 111h / kg 148 / m³ 1,051

CUCINE A GAS

EN GAS COOKERS **DE** GAS HERDE **FR** FOURNEAU À GAZ **ES** **COCINA A GAS**

CF4-78GP

08680850



CUCINA 4 FUOCHI - FORNO A GAS STATICO CM. 67X55X34H, TEMP: 150÷300°C, CON 1 GRIGLIA CM.65X53 GN2/1 (INCLUSA 1 TESTATA CHIUSURA PIANO MOD.TPA-7)

EN Gas Range - N. 4 burners Traditional gas-oven cm. 67x55x34h, temp: 150÷300°C, with 1 grid cm.65x53 GN2/1 (included 1 Head end filler strip mod.TPA-7)

DE Gasherd - N. 4 Kochstellen Statischer Gas-Backofen cm. 67x55x34h, temp: 150÷300°C, mit 1 Rost cm.65x53 GN2/1 (inbegriffen 1 Abschluss-Element mod. TPA-7)

FR Cuisiniere gaz - N. 4 feux vifs Four à gaz statique cm. 67x55x34h, temp: 150÷300°C avec 1 grille cm.65x53 GN2/1 (inclus 1 Élément de jonction top mod.TPA-7)

ES **COCINA A GAS - N. 4 QUEMADORES HORNO A GAS ESTÁTICO CM. 67X55X34H, TEMP: 150÷300°C, CON 1 PARILLA CM.65X53 GN2/1 (INCLUIDA 1 CHAPA DE CIERRE PARA TOP MOD.TPA-7)**

29,3 kW
25.198 kcal/h

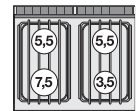
€ 4.682,00

cm. 80 x 70,5 x 90h
 cm. 83 x 77 x 111h / kg 138 / m³ 0,709

CF6-712GPV

08681251



CUCINA 6 FUOCHI FORNO A GAS STATICO CM. 67X55X34H, TEMP: 150÷300°C, CON 1 GRIGLIA CM.65X53 GN2/1 - VANO NEUTRO CON PORTA (INCLUSA 1 TESTATA CHIUSURA PIANO MOD.TPA-7)

EN Gas Range - N. 6 burners Traditional gas-oven GN cm. 67x55x34h, temp: 150÷300°C, with 1 grid cm.65x53 GN2/1 - Neutral cabinet with door (included 1 Head end filler strip mod.TPA-7)

DE Gasherd - N. 6 Kochstellen - Statischer Gas-Backofen cm. 67x55x34h, temp: 150÷300°C, mit 1 Rost cm.65x53 GN2/1 - Neutrales Schrankelement mit Tür (inbegriffen 1 Abschluss-Element mod.TPA-7)

FR Cuisiniere Gaz - N. 6 feux vifs Four à gaz statique cm. 67x55x34h, temp: 150÷300°C avec 1 grille cm.65x53 GN2/1 - Élément neutre avec porte (inclus 1 Élément de jonction top mod.TPA-7)

ES **COCINA A GAS - N. 6 QUEMADORES HORNO A GAS ESTÁTICO CM. 67X55X34H, TEMP: 150÷300°C, CON 1 PARILLA CM.65X53 GN2/1 - ARMARIO NEUTRO CON PUERTA (INCLUIDA 1 CHAPA DE CIERRE PARA TOP MOD.TPA-7)**

42,3 kW
36.378 kcal/h

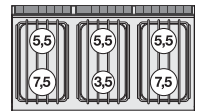
€ 6.235,00

cm. 120 x 70,5 x 90h
 cm. 123 x 77 x 111h / kg 178 / m³ 1,051

CF6-712GP

08681250



CUCINA 6 FUOCHI FORNO A GAS STATICO CM. 107X55X34H, TEMP: 150÷300°C, CON 1 GRIGLIA CM.105X53 (INCLUSA 1 TESTATA CHIUSURA PIANO MOD.TPA-7)

EN Gas Range - N. 6 burners Traditional gas-oven cm. 107x55x34h, temp: 150÷300°C, with 1 grid cm.105x53 (included 1 Head end filler strip mod.TPA-7)

DE Gasherd - N. 6 Kochstellen Statischer Gas-Backofen cm. 107x55x34h, temp: 150÷300°C, mit 1 Rost cm.105x53 (inbegriffen 1 Abschluss-Element mod.TPA-7)

FR Cuisiniere gaz - N. 6 feux vifs Four à gaz statique cm. 107x55x34h, temp: 150÷300°C, avec 1 grille cm.105x53 (inclus 1 Élément de jonction top mod.TPA-7)

ES **COCINA A GAS - N. 6 QUEMADORES HORNO A GAS ESTÁTICO CM. 107X55X34H, TEMP: 150÷300°C, CON 1 PARILLA CM.105X53 (INCLUIDA 1 CHAPA DE CIERRE PARA TOP MOD.TPA-7)**

46 kW
39.560 kcal/h

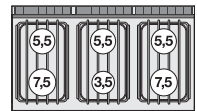
€ 6.972,00

cm. 120 x 70,5 x 90h
 cm. 123 x 77 x 111h / kg 197 / m³ 1,051

CUCINE A GAS CON FORNO ELETTRICO

EN GAS COOKERS WITH ELECTRIC OVEN DE GAS HERDE MIT ELEKTRO-ÖFEN FR FOURNEAU À GAZ AVEC FOUR ÉLECTRIQUE ES COCINA A GAS CON HORNO ELECTRICO

CF4-78GPE

08690860



CUCINA 4 FUOCHI - FORNO ELETTRICO STATICO CM. 67X55X34H, TEMP: 50÷300°C, CON 1 GRIGLIA CM.65X53 GN2/1 (INCLUSA 1 TESTATA CHIUSURA PIANO MOD.TPA-7)

EN Gas Range - N. 4 burners - traditional electric oven cm. 67x55x34h, temp: 50÷300°C, with 1 grid cm.65x53 GN2/1 (included 1 Head end filler strip mod.TPA-7)

DE Gasherd - N. 4 Kochstellen Statischer Elektro-Backofen cm. 67x55x34h, temp: 50÷300°C, mit 1 Rost cm.65x53 GN2/1 (inbegriffen 1 Abschluss-Element mod.TPA-7)

FR Cuisiniere gaz - N. 4 feux vifs Four électrique statique cm. 67x55x34h, temp: 50÷300°C avec 1 grille cm.65x53 GN2/1 (inclus 1 Elément de jonction top mod.TPA-7)

ES COCINA A GAS - N. 4 QUEMADORES HORNO ELÉCTRICO ESTÁTICO CM. 67X55X34H, TEMP: 50÷300°C, CON 1 PARILLA CM.65X53 GN2/1 (INCLUIDA 1 CHAPA DE CIERRE PARA TOP MOD.TPA-7)

cm. 80 x 70,5 x 90h

cm. 83 x 77 x 111h / kg 132 / m³ 0,709

22 kW
18.920 kcal/h

€ 4.682,00

5 kW
400V~3N
50/60 Hz

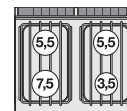

CFV4-78GPE

08800860



CUCINA 4 FUOCHI - FORNO ELETTRICO MULTIFUNZIONE CM. 55X37X34H, TEMP: 50÷260°C, CON 1 GRIGLIA CM.53X32,5 GN1/1 - PORTA INOX (INCLUSA 1 TESTATA CHIUSURA PIANO MOD.TPA-7)

EN Gas Range - N. 4 burners - Multifunction electric oven cm. 55x37x34h, temp: 50÷260°C, with 1 grid cm.53x32,5 GN1/1 - Stainless steel door (included 1 Head end filler strip mod.TPA-7)

DE Gasherd - N. 4 Kochstellen Multifunktions-Elektroöfen cm. 55x37x34h, temp: 50÷260°C, mit 1 Rost cm.53x32,5 GN1/1 - Edelstahltür (inbegriffen 1 Abschluss-Element mod.TPA-7)

FR Cuisiniere gaz - N. 4 feux vifs Four électrique à fonctions multiples cm. 55x37x34h, temp: 50÷260°C avec 1 grille cm.53x32,5 GN1/1 - Porte acier inoxydable (inclus 1 Elément de jonction top mod.TPA-7)

ES COCINA A GAS - N. 4 QUEMADORES HORNO ELÉCTRICO MULTIFUNCIONAL CM. 55X37X34H, TEMP: 50÷250°C, CON 1 PARILLA CM.53X32,5 GN1/1 - PUERTA INOX (INCLUIDA 1 CHAPA DE CIERRE PARA TOP MOD.TPA-7)

cm. 80 x 70,5 x 90h

cm. 83 x 77 x 111h / kg 132 / m³ 0,709

22 kW
18.920 kcal/h

€ 5.260,00

5 kW
400V~3N
230V~3
50/60 Hz

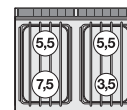

CFV4-78GPE/V

0880086A



CUCINA 4 FUOCHI - FORNO ELETTRICO MULTIFUNZIONE CM. 55X37X34H, TEMP: 50÷260°C, CON 1 GRIGLIA CM.53X32,5 GN1/1 - PORTA VETRO (INCLUSA 1 TESTATA CHIUSURA PIANO MOD.TPA-7)

EN Gas Range - N. 4 burners - Multifunction electric oven cm. 55x37x34h, temp: 50÷260°C, with 1 grid cm.53x32,5 GN1/1 - Glass door (included 1 Head end filler strip mod.TPA-7)

DE Gasherd - N. 4 Kochstellen Multifunktions-Elektroöfen cm. 55x37x34h, temp: 50÷260°C, mit 1 Rost cm.53x32,5 GN1/1 - Glastür (inbegriffen 1 Abschluss-Element mod.TPA-7)

FR Cuisiniere gaz - N. 4 feux vifs Four électrique à fonctions multiples cm. 55x37x34h, temp: 50÷260°C avec 1 grille cm.53x32,5 GN1/1 - Porte vitrée (inclus 1 Elément de jonction top mod.TPA-7)

ES COCINA A GAS - N. 4 QUEMADORES HORNO ELÉCTRICO MULTIFUNCIONAL CM. 55X37X34H, TEMP: 50÷250°C, CON 1 PARILLA CM.53X32,5 GN1/1 - PUERTA VIDRIO (INCLUIDA 1 CHAPA DE CIERRE PARA TOP MOD.TPA-7)

cm. 80 x 70,5 x 90h

cm. 83 x 77 x 111h / kg 132 / m³ 0,709

22 kW
18.920 kcal/h

€ 5.411,00

5 kW
400V~3N
230V~3
50/60 Hz

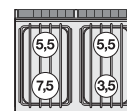

CF6-712GPEV

08691261



CUCINA 6 FUOCHI - FORNO ELETTRICO STATICO CM. 67X55X34H, TEMP: 50÷300°C, CON 1 GRIGLIA CM.65X53 GN2/1 - VANO NEUTRO CON PORTA (INCLUSA 1 TESTATA CHIUSURA PIANO MOD.TPA-7)

EN Gas Range - N. 6 burners - traditional electric oven cm. 67x55x34h, temp: 50÷300°C, with 1 grid cm.65x53 GN2/1 - Neutral cabinet with door (included 1 Head end filler strip mod.TPA-7)

DE Gasherd - N. 6 Kochstellen Statischer Elektro-Backofen cm. 67x55x34h, temp: 50÷300°C, mit 1 Rost cm.65x53 GN2/1 - Neutrales Schrankelement mit Tür (inbegriffen 1 Abschluss-Element mod.TPA-7)

FR Cuisiniere gaz - N. 6 feux vifs Four électrique statique cm. 67x55x34h, temp: 50÷300°C avec 1 grille cm.65x53 GN2/1 - Element neutre avec porte (inclus 1 Elément de jonction top mod.TPA-7)

ES COCINA A GAS - N. 6 QUEMADORES HORNO ELÉCTRICO ESTÁTICO CM. 67X55X34H, TEMP: 50÷300°C, CON 1 PARILLA CM.65X53 GN2/1 - ARMARIO NEUTRO CON PUERTA (INCLUIDA 1 CHAPA DE CIERRE PARA TOP MOD.TPA-7)

cm. 120 x 70,5 x 90h

cm. 123 x 77 x 111h / kg 177 / m³ 1,051

35 kW
30.100 kcal/h

€ 6.235,00

5 kW
400V~3N
50/60 Hz

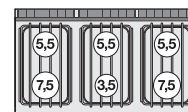

CFV6-712GPEV
 08801260

CUCINA 6 FUOCHI - FORNO ELETTRICO MULTIFUNZIONE CM. 55X37X34H, TEMP: 50÷260°C, CON 1 GRIGLIA CM.53X32,5 GN1/1 - PORTA INOX - VANO NEUTRO CON PORTA (INCLUSA 1 TESTATA CHIUSURA PIANO MOD.TPA-7)

- EN** Gas Range - N. 6 burners - Multifunction electric oven cm. 55x37x34h, temp: 50÷260°C, with 1 grid cm.53x32,5 GN1/1 - Stainless steel door - Neutral cabinet with door (included 1 Head end filler strip mod.TPA-7)
- DE** Gasherd - N. 6 Kochstellen Multifunktions-Elektroofen cm. 55x37x34h, temp: 50÷260°C, mit 1 Rost cm.53x32,5 GN1/1 - Edelstahltür - Neutrales Schrankelement mit Tür (inbegriffen 1 Abschluss-Element mod.TPA-7)
- FR** Cuisiniere gaz - N. 6 feux vifs Four électrique à fonctions multiples cm. 55x37x34h, temp: 50÷260°C avec 1 grille cm.53x32,5 GN1/1 - Porte acier inoxydable - Element neutre avec porte (inclus 1 Élément de jonction top mod.TPA-7)
- ES** **COCINA A GAS - N. 6 QUEMADORES HORNO ELÉCTRICO MULTIFUNCIONAL CM. 55X37X34H, TEMP: 50÷250°C, CON 1 PARILLA CM.53X32,5 GN1/1 - PUERTA INOX - ARMARIO NEUTRO CON PUERTA (INCLUIDA 1 CHAPA DE CIERRE PARA TOP MOD.TPA-7)**

cm. 120 x 70,5 x 90h
 cm. 123 x 77 x 111h / kg 177 / m³ 1,051

€ 6.772,00
 35 kW
 30.100 kcal/h
 5 kW
 400V~3N
 230V~3
 50/60 Hz

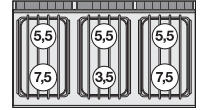

CFV6-712GPEV/V
 0880126A

CUCINA 6 FUOCHI - FORNO ELETTRICO MULTIFUNZIONE CM. 55X37X34H, TEMP: 50÷260°C, CON 1 GRIGLIA CM.53X32,5 GN1/1 - PORTA VETRO - VANO NEUTRO CON PORTA (INCLUSA 1 TESTATA CHIUSURA PIANO MOD.TPA-7)

- EN** Gas Range - N. 6 burners - Multifunction electric oven cm. 55x37x34h, temp: 50÷260°C, with 1 grid cm.53x32,5 GN1/1 - Glass door - Neutral cabinet with door (included 1 Head end filler strip mod.TPA-7)
- DE** Gasherd - N. 6 Kochstellen Multifunktions-Elektroofen cm. 55x37x34h, temp: 50÷260°C, mit 1 Rost cm.53x32,5 GN1/1 - Glastür - Neutrales Schrankelement mit Tür (inbegriffen 1 Abschluss-Element mod.TPA-7)
- FR** Cuisiniere gaz - N. 6 feux vifs Four électrique à fonctions multiples cm. 55x37x34h, temp: 50÷260°C avec 1 grille cm.53x32,5 GN1/1 - Porte vitrée - Element neutre avec porte (inclus 1 Élément de jonction top mod.TPA-7)
- ES** **COCINA A GAS - N. 6 QUEMADORES HORNO ELÉCTRICO MULTIFUNCIONAL CM. 55X37X34H, TEMP: 50÷250°C, CON 1 PARILLA CM.53X32,5 GN1/1 - PUERTA VIDRIO - ARMARIO NEUTRO CON PUERTA (INCLUIDA 1 CHAPA DE CIERRE PARA TOP MOD.TPA-7)**

cm. 120 x 70,5 x 90h
 cm. 123 x 77 x 111h / kg 177 / m³ 1,051

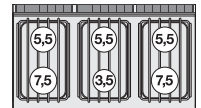
€ 6.923,00
 35 kW
 30.100 kcal/h
 5 kW
 400V~3N
 230V~3
 50/60 Hz



CF6-712GPE
 08691260

CUCINA 6 FUOCHI FORNO ELETTRICO STATICO CM. 107X55X34H, TEMP: 50÷300°C, CON 1 GRIGLIA CM.105X53 (INCLUSA 1 TESTATA CHIUSURA PIANO MOD.TPA-7)

- EN** Gas Range - N. 6 burners Traditional electric oven cm. 107x55x34h, temp: 50÷300°C, with 1 grid cm.105x53 (included 1 Head end filler strip mod.TPA-7)
- DE** Gasherd - N. 6 Kochstellen Statischer Elektro-Backofen cm. 107x55x34h, temp: 50÷300°C, mit 1 Rost cm.105x53 (inbegriffen 1 Abschluss-Element mod.TPA-7)
- FR** Cuisiniere gaz - N. 6 feux vifs Four électrique statique cm. 107x55x34h, temp: 50÷300°C, avec 1 grille cm.105x53 (inclus 1 Élément de jonction top mod.TPA-7)
- ES** **COCINA A GAS - N. 6 QUEMADORES HORNO ELÉCTRICO ESTÁTICO CM. 107X55X34H, TEMP: 50÷300°C, CON 1 PARILLA CM.105X53 (INCLUIDA 1 CHAPA DE CIERRE PARA TOP MOD.TPA-7)**

cm. 120 x 70,5 x 90h
 cm. 123 x 77 x 111h / kg 190 / m³ 1,051

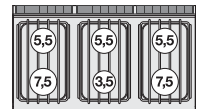
€ 6.972,00
 35 kW
 30.100 kcal/h
 6,9 kW
 400V~3N
 50/60 Hz

CUCINA ACQUA A GAS

EN GAS WATER FED COOKERS **DE** HERD WASSER GAS **FR** FOURNEAU À GAZ AVEC BAC À REMPLISSAGE D'EAU **ES** **COCINA DE AGUA A GAS**

CFA4-78GP
 08750850

CUCINA ACQUA 4 FUOCHI - FORNO A GAS STATICO CM. 67X55X34H, TEMP: 150÷300°C, CON 1 GRIGLIA CM.65X53 GN2/1 - RUBINETTO CARICO ACQUA, SFIORATORE (INCLUSA 1 TESTATA CHIUSURA PIANO MOD.TPA-7)

- EN** Water range - N. 4 burners Traditional gas-oven cm. 67x55x34h, temp: 150÷300°C, with 1 grid cm.65x53 GN2/1 - Water loading tap + overflow device (included 1 Head end filler strip mod.TPA-7)
- DE** Wasser herd - N. 4 Kochstellen Statischer Gas-Backofen cm. 67x55x34h, temp: 150÷300°C, mit 1 Rost cm.65x53 GN2/1 - Wasserlauf-Hahn + Überlauf-Vorrichtung (inbegriffen 1 Abschluss-Element mod.TPA-7)
- FR** Cuisinière l'eau - N. 4 feux vifs Four à gaz statique cm. 67x55x34h, temp: 150÷300°C avec 1 grille cm.65x53 GN2/1 - Robinet d'arrivée d'eau trop plein (inclus 1 Élément de jonction top mod.TPA-7)
- ES** **COCINA A AGUA - N. 4 QUEMADORES HORNO A GAS ESTÁTICO CM. 67X55X34H, TEMP: 150÷300°C, CON 1 PARILLA CM.65X53 GN2/1 - GRIFO CARGA AGUA + VERTEDERO (INCLUIDA 1 CHAPA DE CIERRE PARA TOP MOD.TPA-7)**

cm. 80 x 70,5 x 90h
 cm. 83 x 77 x 111h / kg 138 / m³ 0,709

€ 6.512,00
 35,3 kW
 30.358 kcal/h

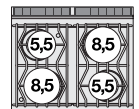

CFA6-712GPV

08751251



CUCINA ACQUA 6 FUOCHI - FORNO A GAS STATICO CM. 67X55X34H, TEMP: 150÷300°C, CON 1 GRIGLIA CM.65X53 GN2/1 - VANO NEUTRO CON PORTA - RUBINETTO CARICO ACQUA, SFIORATORE (INCLUSA 1 TESTATA CHIUSURA PIANO MOD.TPA-7)

EN Water range - N. 6 burners - Traditional gas-oven cm. 67x55x34h, temp: 150÷300°C, with 1 grid cm.65x53 GN2/1 - Neutral cabinet with door - Water loading tap + overflow device (included 1 Head end filler strip mod.TPA-7)

DE Wasser herd - N. 6 Kochstellen - Statischer Gas-Backofen cm. 67x55x34h, temp: 150÷300°C, mit 1 Rost cm.65x53 GN2/1 - Neutrales Schrankelement mit Tür - Wasserlauf-Hahn + Überlauf-Vorrichtung (inbegriffen 1 Abschluss-Element mod. TPA-7)

FR Cuisiniere l'eau - N. 6 feux vifs Four à gaz statique cm. 67x55x34h, temp: 150÷300°C avec 1 grille cm.65x53 GN2/1 - Element neutre avec porte - Robinet d'arrivée d'eau trop plein (inclus 1 Élément de jonction top mod.TPA-7)

ES **COCINA A AGUA N. 6 QUEMADORES HORNO A GAS ESTÁTICO CM. 67X55X34H, TEMP: 150÷300°C, CON 1 PARILLA CM.65X53 GN2/1 - ARMARIO NEUTRO CON PUERTA - GRIFO CARGA AGUA + VERTEDERO (INCLUIDA 1 CHAPA DE CIERRE PARA TOP MOD.TPA-7)**

cm. 120 x 70,5 x 90h

cm. 123 x 77 x 111h / kg 178 / m³ 1,051

49,3 kW
42.398 kcal/h

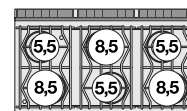
€ 7.569,00**PIANI COTTURA ELETTRICI**

EN ELECTRIC BOILING UNIT **DE** ELEKTRO KOCHPLATTEN **FR** PLAN DE CUISSON ÉLECTRIQUE **ES** SOBRES DE COCCIÓN ELECTRICO

PC-74ET

08030430



PIANO COTTURA TRIFASE SU MOBILE A GIORNO - N. 2 PIASTRE (INCLUSA 1 TESTATA CHIUSURA PIANO MOD.TPA-7)

EN Boiling unit threephase on open cabinet - N. 2 plates (included 1 Head end filler strip mod.TPA-7)

DE Kochplatte dreiphasig mit offenem Unterbau N. 2 Kochplatten (inbegriffen 1 Abschluss-Element mod.TPA-7)

FR Rechaud électriques sur armoire ouvert - N. 2 plaques (inclus 1 Élément de jonction top mod.TPA-7)

ES **SOBRE DE COCCIÓN TRIFÁSICO SOBRE MUEBLE ABIERTO N. 2 PLANCHAS (INCLUIDA 1 CHAPA DE CIERRE PARA TOP MOD.TPA-7)**

cm. 40 x 70,5 x 90h

cm. 43 x 77 x 111h / kg 42 / m³ 0,368

5,2 kW
400V~2N
230V~3
230V~
50/60 Hz

€ 1.368,00**PC-78ET**

08030830



PIANO COTTURA TRIFASE SU MOBILE A GIORNO N. 4 PIASTRE (INCLUSA 1 TESTATA CHIUSURA PIANO MOD.TPA-7)

EN Threephase boiling unit on open cabinet - N. 4 plates (included 1 Head end filler strip mod.TPA-7)

DE Kochplatte dreiphasig mit offenem Unterbau N. 4 Kochplatten (inbegriffen 1 Abschluss-Element mod.TPA-7)

FR Rechaud triphase sur armoire ouvert - N. 4 plaques (inclus 1 Élément de jonction top mod.TPA-7)

ES **SOBRE DE COCCIÓN TRIFÁSICO SOBRE MUEBLE ABIERTO N. 4 PLANCHAS (INCLUIDA 1 CHAPA DE CIERRE PARA TOP MOD.TPA-7)**

cm. 80 x 70,5 x 90h

cm. 83 x 77 x 111h / kg 68 / m³ 0,709

10,4 kW
400V~3N
230V~3
50/60 Hz

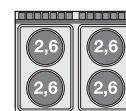
€ 2.105,00**PC-712ET**

08031230



PIANO COTTURA TRIFASE SU MOBILE A GIORNO N. 6 PIASTRE (INCLUSA 1 TESTATA CHIUSURA PIANO MOD.TPA-7)

EN Threephase boiling unit on open cabinet - N. 6 plates (included 1 Head end filler strip mod.TPA-7)

DE Kochplatte dreiphasig mit offenem Unterbau N. 6 Kochplatten (inbegriffen 1 Abschluss-Element mod.TPA-7)

FR Rechaud triphase sur armoire ouvert - N. 6 plaques (inclus 1 Élément de jonction top mod.TPA-7)

ES **SOBRE DE COCCIÓN TRIFÁSICO SOBRE MUEBLE ABIERTO N. 6 PLANCHAS (INCLUIDA 1 CHAPA DE CIERRE PARA TOP MOD.TPA-7)**

cm. 120 x 70,5 x 90h

cm. 123 x 77 x 111h / kg 88 / m³ 1,051

15,6 kW
400V~3N
230V~3
50/60 Hz

€ 2.925,00

PCQ-74ET

08030431



PIANO COTTURA TRIFASE SU MOBILE A GIORNO - N. 2 PIASTRE QUADRE (INCLUSA 1 TESTATA CHIUSURA PIANO MOD.TPA-7)

- EN** Boiling unit threephase on open cabinet - N. 2 square plates (included 1 Head end filler strip mod.TPA-7)
- DE** Kochplatte dreiphasig mit offenem Unterbau N. 2 quadratischen Platten (inbegriffen 1 Abschluss-Element mod.TPA-7)
- FR** Rechaud électrique sur armoire ouvert - N. 2 plaques carrés (inclus 1 Élément de jonction top mod.TPA-7)

ES SOBRE DE COCCIÓN TRIFÁSICO SOBRE MUEBLE ABIERTO N. 2 PLANCHAS CUADRADAS (INCLUIDA 1 CHAPA DE CIERRE PARA TOP MOD. TPA-7)

- cm. 40 x 70,5 x 90h
- cm. 43 x 77 x 111h / kg 46 / m³ 0,368

5,2 kW
400V~2N
230V~3
230V~
50/60 Hz

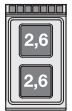
€ 2.042,00

PCQ-78ET

08030831



PIANO COTTURA TRIFASE SU MOBILE A GIORNO - N. 4 PIASTRE QUADRE (INCLUSA 1 TESTATA CHIUSURA PIANO MOD.TPA-7)

- EN** Boiling unit threephase on open cabinet - N. 4 square plates (included 1 Head end filler strip mod.TPA-7)
- DE** Kochplatte dreiphasig mit offenem Unterbau N. 4 quadratischen Platten (inbegriffen 1 Abschluss-Element mod.TPA-7)
- FR** Rechaud électriques sur armoire ouvert - N. 4 plaques carrés (inclus 1 Élément de jonction top mod.TPA-7)

ES SOBRE DE COCCIÓN TRIFÁSICO SOBRE MUEBLE ABIERTO N. 4 PLANCHAS CUADRADAS (INCLUIDA 1 CHAPA DE CIERRE PARA TOP MOD. TPA-7)

- cm. 80 x 70,5 x 90h
- cm. 83 x 77 x 111h / kg 71 / m³ 0,709

10,4 kW
400V~3N
230V~3
50/60 Hz

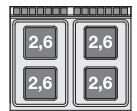
€ 3.548,00

PCQ-712ET

08031231



PIANO COTTURA TRIFASE SU MOBILE A GIORNO - N. 6 PIASTRE QUADRE (INCLUSA 1 TESTATA CHIUSURA PIANO MOD.TPA-7)

- EN** Boiling unit threephase on open cabinet - N. 6 square plates (included 1 Head end filler strip mod.TPA-7)
- DE** Kochplatte dreiphasig mit offenem Unterbau N. 6 quadratischen Platten (inbegriffen 1 Abschluss-Element mod.TPA-7)
- FR** Rechaud électriques sur armoire ouvert - N. 6 plaques carrés (inclus 1 Élément de jonction top mod.TPA-7)

ES SOBRE DE COCCIÓN TRIFÁSICO SOBRE MUEBLE ABIERTO N. 6 PLANCHAS CUADRADAS (INCLUIDA 1 CHAPA DE CIERRE PARA TOP MOD. TPA-7)

- cm. 120 x 70,5 x 90h
- cm. 123 x 77 x 111h / kg 103 / m³ 1,051

15,6 kW
400V~3N
230V~3
50/60 Hz

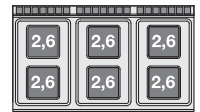
€ 5.057,00

PCC-74ET

08030432



PIANO COTTURA VETROCERAMICA TRIFASE SU MOBILE A GIORNO - N. 2 ZONE - VETRO CM.35X57 (INCLUSA 1 TESTATA CHIUSURA PIANO MOD.TPA-7)

- EN** Ceramic glass boiling unit on open cabinet - n. 2 zones - glass cm.35x57 (included 1 Head end filler strip mod.TPA-7)
- DE** Ceran-Kochplatte dreiphasig mit offenem Unterbau - 2 zonen - Glas 35x57 cm (inbegriffen 1 Abschluss-Element mod.TPA-7)
- FR** Plan de cuisson à vitroceramique triphasé sur armoire ouvert N. 2 zones - Verre cm.35x57 (inclus 1 Élément de jonction top mod.TPA-7)

ES SOBRE DE COCCIÓN TRIFÁSICO VITROCERÁMICA SOBRE MUEBLE ABIERTO - 2 ZONAS - VIDRIO CM.35X57 (INCLUIDA 1 CHAPA DE CIERRE PARA TOP MOD.TPA-7)

- cm. 40 x 70,5 x 90h
- cm. 43 x 77 x 111h / kg 41 / m³ 0,368

5 kW
400V~2N
230V~3
230V~
50/60 Hz

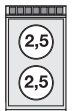
€ 2.592,00

PCC-78ET

08030832



PIANO COTTURA VETROCERAMICA TRIFASE SU MOBILE A GIORNO - N. 4 ZONE - VETRO CM. 75X57 (INCLUSA 1 TESTATA CHIUSURA PIANO MOD.TPA-7)

- EN** Ceramic glass boiling unit on open cabinet - n. 4 zones - glass cm. 75 x 57 (included 1 Head end filler strip mod.TPA-7)
- DE** Ceran-Kochplatte dreiphasig mit offenem Unterbau - 4 zonen - Glas 75x57 cm (inbegriffen 1 Abschluss-Element mod.TPA-7)
- FR** Plan de cuisson à vitroceramique triphasé sur armoire ouvert N. 4 zones - Verre cm 75x57 (inclus 1 Élément de jonction top mod.TPA-7)

ES SOBRE DE COCCIÓN TRIFÁSICO VITROCERÁMICA SOBRE MUEBLE ABIERTO - 4 ZONAS - VIDRIO CM. 75 X 57 (INCLUIDA 1 CHAPA DE CIERRE PARA TOP MOD.TPA-7)

- cm. 80 x 70,5 x 90h
- cm. 83 x 77 x 111h / kg 66 / m³ 0,709

10 kW
400V~3N
230V~3
50/60 Hz

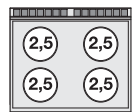
€ 3.813,00

PIANI COTTURA A INDUZIONE

EN INDUCTION BOILING UNIT DE INDUKTIONNS-KOCHPLATTEN FR PLAN DE CUISSON À INDUCTION ES SOBRES DE COCCIÓN POR INDUCCIÓN

PCI-74ET
 08030433

PIANO COTTURA INDUZIONE TRIFASE - N. 2 ZONE - VETRO CM.35X57 (INCLUSA 1 TESTATA CHIUSURA PIANO MOD.TPA-7)

EN Three-phase induction cooking - 2 zones - glass cm.35x57 (included 1 Head end filler strip mod.TPA-7)

DE Induktions-Kochplatte dreiphasig - 2 zonen - Glas 35x57 cm (inbegriffen 1 Abschluss-Element mod.TPA-7)

FR Plan de cuisson à induction triphasé N. 2 zones - Verre cm.35x57 (inclus 1 Elément de jonction top mod.TPA-7)

ES ENCIMERA INDUCCIÓN TRIFÁSICA - 2 ZONAS - VIDRIO CM.35X57 (INCLUIDA 1 CHAPA DE CIERRE PARA TOP MOD.TPA-7)

cm. 40 x 70,5 x 90h

cm. 43 x 77 x 111h / kg 40 / m³ 0,368

10 kW € 8.208,00
 400V~3
 50/60 Hz

PCIW-74ET
 08030434

PIANO COTTURA INDUZIONE TRIFASE "WOK" - N. 1 ZONA - VETRO Ø 30 CM. (INCLUSA 1 TESTATA CHIUSURA PIANO MOD.TPA-7)

EN Three-phase induction cooking "WOK" - 1 zone - glass Ø 30 cm (included 1 Head end filler strip mod.TPA-7)

DE Induktions-Kochplatte "WOK" dreiphasig - 1 zonen - Glas Ø 30 cm (inbegriffen 1 Abschluss-Element mod.TPA-7)

FR Plan de cuisson à induction "WOK" triphasé N. 1 zone - Verre cm Ø 30 (inclus 1 Elément de jonction top mod.TPA-7)

ES ENCIMERA INDUCCIÓN "WOK" TRIFÁSICA - 1 ZONA - VIDRIO Ø 30 CM (INCLUIDA 1 CHAPA DE CIERRE PARA TOP MOD.TPA-7)

cm. 40 x 70,5 x 90h

cm. 43 x 77 x 111h / kg 38 / m³ 0,368

4,5 kW € 5.802,00
 400V~3
 50/60 Hz

PCI-78ET
 08030833

PIANO COTTURA INDUZIONE TRIFASE - N. 4 ZONE - VETRO CM.75X57 (INCLUSA 1 TESTATA CHIUSURA PIANO MOD.TPA-7)

EN Three-phase induction cooking - 4 zones - glass cm.75x57 (included 1 Head end filler strip mod.TPA-7)

DE Induktions-Kochplatte dreiphasig - 4 zonen - Glas 75x57 cm (inbegriffen 1 Abschluss-Element mod.TPA-7)

FR Plan de cuisson à induction triphasé N. 4 zones - Verre cm.75x57 (inclus 1 Elément de jonction top mod.TPA-7)

ES ENCIMERA INDUCCIÓN TRIFÁSICA - 4 ZONAS - VIDRIO CM.75X57 (INCLUIDA 1 CHAPA DE CIERRE PARA TOP MOD.TPA-7)

cm. 80 x 70,5 x 90h

cm. 83 x 77 x 111h / kg 70 / m³ 0,709

20 kW € 15.444,00
 400V~3
 50/60 Hz

PIANI COTTURA A GAS
EN GAS BOILING UNIT DE GAS KOCHPLATTEN FR PLAN DE CUISSON À GAZ ES SOBRES DE COCCIÓN DE GAS
PC-74GP
 08210450

PIANO COTTURA GAS SU MOBILE A GIORNO 2 FUOCHI (INCLUSA 1 TESTATA CHIUSURA PIANO MOD.TPA-7)

EN Gas heated boiling unit on open cabinet - 2 burners (included 1 Head end filler strip mod.TPA-7)

DE Gas-kochplatte mit offenem Unterbau - 2 Kochstellen (inbegriffen 1 Abschluss-Element mod.TPA-7)

FR Rechaud gaz sur armoire ouvert - 2 feux vifs (inclus 1 Élément de jonction top mod. TPA-7)

ES **SOBRES DE COCCIÓN GAS SOBRE MUEBLE ABIERTO - 2 QUEMADORES (INCLUIDA 1 CHAPA DE CIERRE PARA TOP MOD.TPA-7)**

cm. 40 x 70,5 x 90h

cm. 43 x 77 x 111h / kg 63 / m³ 0,368

13 kW
11.180 kcal/h

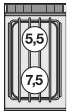
€ 1.921,00

PC-78GP
 08210850

PIANO COTTURA GAS SU MOBILE A GIORNO 4 FUOCHI (INCLUSA 1 TESTATA CHIUSURA PIANO MOD.TPA-7)

EN Gas heated boiling unit on open cabinet - 4 burners (included 1 Head end filler strip mod.TPA-7)

DE Gas-Kochplatte mit offenem Unterbau - 4 Kochstellen (inbegriffen 1 Abschluss-Element mod.TPA-7)

FR Rechaud gaz sur armoire ouvert - 4 feux vifs (inclus 1 Élément de jonction top mod. TPA-7)

ES **SOBRES DE COCCIÓN GAS SOBRE MUEBLE ABIERTO - 4 QUEMADORES (INCLUIDA 1 CHAPA DE CIERRE PARA TOP MOD.TPA-7)**

cm. 80 x 70,5 x 90h

cm. 83 x 77 x 111h / kg 76 / m³ 0,709

22 kW
18.920 kcal/h

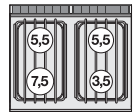
€ 3.073,00

PC-712GP
 08211250

PIANO COTTURA GAS SU MOBILE A GIORNO 6 FUOCHI (INCLUSA 1 TESTATA CHIUSURA PIANO MOD.TPA-7)

EN Gas heated boiling unit on open cabinet - 6 burners (included 1 Head end filler strip mod.TPA-7)

DE Gas-Kochplatte mit offenem Unterbau - 6 Kochstellen (inbegriffen 1 Abschluss-Element mod.TPA-7)

FR Rechaud gaz sur armoire ouvert - 6 feux vifs (inclus 1 Élément de jonction top mod. TPA-7)

ES **SOBRES DE COCCIÓN GAS SOBRE MUEBLE ABIERTO - 6 QUEMADORES (INCLUIDA 1 CHAPA DE CIERRE PARA TOP MOD.TPA-7)**

cm. 120 x 70,5 x 90h

cm. 123 x 77 x 111h / kg 126 / m³ 1,051

35 kW
30.100 kcal/h

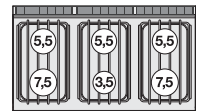
€ 4.401,00

PC1-74G
 08210453

PIANO COTTURA GAS SU MOBILE A GIORNO 1 FUOCHI (INCLUSA 1 TESTATA CHIUSURA PIANO MOD.TPA-7)

EN Gas heated boiling unit on open cabinet - 1 burners (included 1 Head end filler strip mod.TPA-7)

DE Gas-kochplatte mit offenem Unterbau - 1 Kochstellen (inbegriffen 1 Abschluss-Element mod.TPA-7)

FR Rechaud gaz sur armoire ouvert - 1 feux vifs (inclus 1 Élément de jonction top mod. TPA-7)

ES **SOBRES DE COCCIÓN GAS SOBRE MUEBLE ABIERTO - 1 QUEMADORES (INCLUIDA 1 CHAPA DE CIERRE PARA TOP MOD.TPA-7)**

cm. 40 x 70,5 x 90h

cm. 43 x 77 x 111h / kg 63 / m³ 0,368

10 kW
8.600 kcal/h

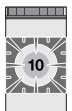
€ 1.945,00

PC2-78G
 08210853

PIANO COTTURA GAS SU MOBILE A GIORNO 2 FUOCHI (INCLUSA 1 TESTATA CHIUSURA PIANO MOD.TPA-7)

EN Gas heated boiling unit on open cabinet - 2 burners (included 1 Head end filler strip mod.TPA-7)

DE Gas-kochplatte mit offenem Unterbau - 2 Kochstellen (inbegriffen 1 Abschluss-Element mod.TPA-7)

FR Rechaud gaz sur armoire ouvert - 2 feux vifs (inclus 1 Élément de jonction top mod. TPA-7)

ES **SOBRES DE COCCIÓN GAS SOBRE MUEBLE ABIERTO - 2 QUEMADORES (INCLUIDA 1 CHAPA DE CIERRE PARA TOP MOD.TPA-7)**

cm. 80 x 70,5 x 90h

cm. 83 x 77 x 111h / kg 76 / m³ 0,709

17 kW
14.620 kcal/h

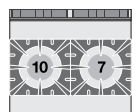
€ 3.016,00

PC3-712G

08211253



PIANO COTTURA GAS SU MOBILE A GIORNO 3 FUOCHI (INCLUSA 1 TESTATA CHIUSURA PIANO MOD.TPA-7)

- EN** Gas heated boiling unit on open cabinet - 3 burners (included 1 Head end filler strip mod.TPA-7)
- DE** Gas-Kochplatte mit offenem Unterbau - 3 Kochstellen (inbegriffen 1 Abschluss-Element mod.TPA-7)
- FR** Rechaud gaz sur armoire ouvert - 3 feux vifs (inclus 1 Élément de jonction top mod.TPA-7)
- ES** **SOBRES DE COCCIÓN GAS SOBRE MUEBLE ABIERTO - 3 QUEMADORES (INCLUIDA 1 CHAPA DE CIERRE PARA TOP MOD.TPA-7)**

- cm. 120 x 70,5 x 90h
- cm. 123 x 77 x 111h / kg 126 / m³ 1,051

⚡ 27 kW **€ 4.224,00**
23.220 kcal/h

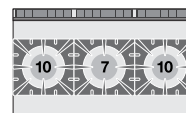
**PIANI COTTURA AD ACQUA A GAS**

EN GAS WATER FED BOILING UNIT **DE** GAS WASSERKOCHEPLATTEN **FR** PLAN DE CUISSON À GAZ AVEC BAC À REMPLISSAGE D'EAU **ES** **SOBRES DE COCCIÓN DE AGUA A GAS**

PCA-74GP

08310450



PIANO COTTURA ACQUA SU MOBILE A GIORNO 2 FUOCHI - RUBINETTO CARICO ACQUA, SFIORATORE (INCLUSA 1 TESTATA CHIUSURA PIANO MOD.TPA-7)

- EN** water heated boiling unit on open cabinet - 2 burners - Water loading tap + overflow device (included 1 Head end filler strip mod.TPA-7)
- DE** wasser-kochplatte mit offenem Unterbau - 2 Kochstellen - Wasserlauf-Hahn + Überlauf-Vorrichtung (inbegriffen 1 Abschluss-Element mod.TPA-7)
- FR** Rechaud l'eau sur armoire ouvert - 2 feux vifs - Robinet d'arrivée d'eau trop plein (inclus 1 Élément de jonction top mod.TPA-7)
- ES** **SOBRES DE COCCIÓN AGUA SOBRE MUEBLE ABIERTO 2 QUEMADORES - GRIFO CARGA AGUA + VERTEDERO (INCLUIDA 1 CHAPA DE CIERRE PARA TOP MOD.TPA-7)**

- cm. 40 x 70,5 x 90h
- cm. 43 x 77 x 111h / kg 63 / m³ 0,368

⚡ 14 kW **€ 2.141,00**
12.040 kcal/h

**PCA-78GP**

08310850



PIANO COTTURA ACQUA SU MOBILE A GIORNO 4 FUOCHI - RUBINETTO CARICO ACQUA, SFIORATORE (INCLUSA 1 TESTATA CHIUSURA PIANO MOD.TPA-7)

- EN** water heated boiling unit on open cabinet - 4 burners - Water loading tap + overflow device (included 1 Head end filler strip mod.TPA-7)
- DE** wasser-kochplatte mit offenem Unterbau - 4 Kochstellen - Wasserlauf-Hahn + Überlauf-Vorrichtung (inbegriffen 1 Abschluss-Element mod.TPA-7)
- FR** Rechaud l'eau sur armoire ouvert - 4 feux vifs - Robinet d'arrivée d'eau trop plein (inclus 1 Élément de jonction top mod.TPA-7)
- ES** **SOBRES DE COCCIÓN AGUA SOBRE MUEBLE ABIERTO 4 QUEMADORES - GRIFO CARGA AGUA + VERTEDERO (INCLUIDA 1 CHAPA DE CIERRE PARA TOP MOD.TPA-7)**

- cm. 80 x 70,5 x 90h
- cm. 83 x 77 x 111h / kg 76 / m³ 0,709

⚡ 28 kW **€ 4.189,00**
24.080 kcal/h

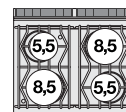
**PCA-712GP**

08311250



PIANO COTTURA ACQUA SU MOBILE A GIORNO 6 FUOCHI - RUBINETTO CARICO ACQUA, SFIORATORE (INCLUSA 1 TESTATA CHIUSURA PIANO MOD.TPA-7)

- EN** water heated boiling unit on open cabinet - 6 burners - Water loading tap + overflow device (included 1 Head end filler strip mod.TPA-7)
- DE** wasser-kochplatte mit offenem Unterbau - 6 Kochstellen - Wasserlauf-Hahn + Überlauf-Vorrichtung (inbegriffen 1 Abschluss-Element mod.TPA-7)
- FR** Rechaud l'eau sur armoire ouvert - 6 feux vifs - Robinet d'arrivée d'eau trop plein (inclus 1 Élément de jonction top mod.TPA-7)
- ES** **SOBRES DE COCCIÓN AGUA SOBRE MUEBLE ABIERTO 6 QUEMADORES - GRIFO CARGA AGUA + VERTEDERO (INCLUIDA 1 CHAPA DE CIERRE PARA TOP MOD.TPA-7)**

- cm. 120 x 70,5 x 90h
- cm. 123 x 77 x 111h / kg 126 / m³ 1,051

⚡ 42 kW **€ 6.019,00**
36.120 kcal/h

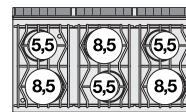

PIANI COTTURA "PAELLERO" A GAS
EN GAS BOILING UNIT "PAELLERO" DE GAS KOCHPLATTEN "PAELLERO" FR PLAN DE CUISSON À GAZ "PAELLERO" ES SOBRES DE COCCIÓN DE GAS "PAELLERO"
PA-78G
 08210851

"PAELLERO" GAS SU MOBILE A GIORNO (INCLUSA 1 TESTATA CHIUSURA PIANO MOD. TPA-7)

 11,5 kW
 9.890 kcal/h **€ 3.640,00**
EN "PAELLERO" Gas - open cabinet (included 1 Head end filler strip mod.TPA-7)
DE "PAELLERO" Gas mit offenem Unterbau (inbegriffen 1 Abschluss-Element mod. TPA-7)
FR "PAELLERO" gaz sur armoire ouvert (inclus 1 Élément de jonction top mod.TPA-7)
ES "PAELLERO" GAS SOBRE MUEBLE ABIERTO (INCLUIDA 1 CHAPA DE CIERRE PARA TOP MOD.TPA-7)

 cm. 80 x 70,5 x 90h
 cm. 83 x 77 x 111h / kg 111 / m³ 0,709

PAF-78G
 08680851

"PAELLERO" GAS SU FORNO GAS STATICO CM. 67X55X34H, TEMP: 150÷300°C, CON 1 GRIGLIA CM.65X53 GN2/1 (INCLUSA 1 TESTATA CHIUSURA PIANO MOD.TPA-7)

 18,8 kW
 16.168 kcal/h **€ 4.553,00**
EN "PAELLERO" Gas on Traditional gas-oven cm. 67x55x34h, temp: 150÷300°C, with 1 grid cm.65x53 GN2/1 (included 1 Head end filler strip mod.TPA-7)
DE "PAELLERO" Gas mit Statischer Gas-Backofen cm. 67x55x34h, temp: 150÷300°C, mit 1 Rost cm.65x53 GN2/1 (inbegriffen 1 Abschluss-Element mod.TPA-7)
FR "PAELLERO" gaz sur Four à gaz statique cm. 67x55x34h, temp: 150÷300°C, avec 1 grille cm.65x53 GN2/1 (inclus 1 Élément de jonction top mod.TPA-7)
ES "PAELLERO" GAS SOBRE HORNO A GAS ESTÁTICO CM. 67X55X34H, TEMP: 150÷300°C, CON 1 PARILLA CM.65X53 GN2/1 (INCLUIDA 1 CHAPA DE CIERRE PARA TOP MOD.TPA-7)

 cm. 80 x 70,5 x 90h
 cm. 83 x 77 x 111h / kg 159 / m³ 0,709

TUTTAPIASTRA ELETTRICO CON FORNO
EN ELECTRIC SOLID TOP WITH OVEN DE ELEKTRO-KOCHPLATTEN MIT ÖFEN FR TOUTE PLAQUE ÉLECTRIQUE AVEC FOUR ES PLACA DE COCCIÓN ELECTRICAS CON HORNO
TPF-78ET
 08670830

TUTTA PIASTRA SU FORNO ELETTRICO STATICO CM. 67X55X34H, TEMP: 50÷300°C, CON 1 GRIGLIA CM.65X53 GN2/1 - PIASTRA CM. 70X50 4 ZONE (INCLUSA 1 TESTATA CHIUSURA PIANO MOD.TPA-7)

 15 kW
 400V~3N
 50/60 Hz **€ 5.634,00**
EN Solid top on traditional electric oven cm. 67x55x34h, temp: 50÷300°C, with 1 grid cm.65x53 GN2/1 - Plate cm. 70x50 4 zones (included 1 Head end filler strip mod. TPA-7)
DE Kochplatten - Statischer Elektro-Backofen cm. 67x55x34h, temp: 50÷300°C, mit 1 Rost cm.65x53 GN2/1 - Platte cm. 70x50 4 zonen (inbegriffen 1 Abschluss-Element mod.TPA-7)
FR Toute plaque sur Four électrique statique cm. 67x55x34h, temp: 50÷300°C, avec 1 grille cm.65x53 GN2/1 - Plaque cm. 70x50 4 zones (inclus 1 Élément de jonction top mod.TPA-7)
ES PLACA RADIANTE SOBRE HORNO ELÉCTRICO ESTÁTICO CM. 67X55X34H, TEMP: 50÷300°C, CON 1 PARILLA CM.65X53 GN2/1 - PLACA CM. 70X50 4 ZONAS (INCLUIDA 1 CHAPA DE CIERRE PARA TOP MOD.TPA-7)

 cm. 80 x 70,5 x 90h
 cm. 83 x 77 x 111h / kg 170 / m³ 0,709

TPFV-78ET
 08810830

TUTTA PIASTRA SU FORNO ELETTRICO MULTIFUNZIONE CM. 55X37X34H, TEMP: 50÷260°C, CON 1 GRIGLIA CM.53X32,5 GN1/1 - PORTA INOX - PIASTRA CM. 70X50 4 ZONE (INCLUSA 1 TESTATA CHIUSURA PIANO MOD.TPA-7)

 15 kW
 400V~3N
 50/60 Hz **€ 6.194,00**
EN Solid top on Multifunction electric oven cm. 55x37x34h, temp: 50÷260°C, with 1 grid cm.53x32,5 GN1/1 - Stainless steel door - Plate cm. 70x50 4 zones (included 1 Head end filler strip mod.TPA-7)
DE Kochplatten - Multifunktions-Elektroofen cm. 55x37x34h, temp: 50÷260°C, mit 1 Rost cm.53x32,5 GN1/1 - Edelstahltür - Platte cm. 70x50 4 Zonen (inbegriffen 1 Abschluss-Element mod.TPA-7)
FR Toute plaque sur Four électrique à fonctions multiples cm. 55x37x34h, temp: 50÷260°C, avec 1 grille cm.53x32,5 GN1/1 - Porte acier inoxydable - Plaque cm. 70x50 4 zones (inclus 1 Élément de jonction top mod.TPA-7)
ES PLACA RADIANTE SOBRE HORNO ELÉCTRICO MULTIFUNCIONAL CM. 55X37X34H, TEMP: 50÷260°C, CON 1 PARILLA CM.53X32,5 GN1/1 - PUERTA INOX - PLACA CM. 70X50 4 ZONAS (INCLUIDA 1 CHAPA DE CIERRE PARA TOP MOD.TPA-7)

 cm. 80 x 70,5 x 90h
 cm. 83 x 77 x 111h / kg 170 / m³ 0,709

TPFV-78ET/V

0881083A



TUTTA PIASTRA SU FORNO ELETTRICO MULTIFUNZIONE CM. 55X37X34H, TEMP: 50÷260°C, CON 1 GRIGLIA CM.53X32,5 GN1/1 - PORTA VETRO - PIASTRA CM. 70X50 4 ZONE (INCLUSA 1 TESTATA CHIUSURA PIANO MOD.TPA-7)

EN Solid top on Multifunction electric oven cm. 55x37x34h, temp: 50÷260°C, with 1 grid cm.53x32,5 GN1/1 - Glass door - Plate cm. 70x50 4 zones (included 1 Head end filler strip mod.TPA-7)

DE Kochplatten - Multifunktions-Elektroofen cm. 55x37x34h, temp: 50÷260°C, mit 1 Rost cm.53x32,5 GN1/1 - Glastür - Platte cm. 70x50 4 Zonen (inbegriffen 1 Abschluss-Element mod.TPA-7)

FR Toute plaque sur Four électrique à fonctions multiples cm. 55x37x34h, temp: 50÷260°C, avec 1 grille cm.53x32,5 GN1/1 - Porte vitrée - Plaque cm. 70x50 4 zones (inclus 1 Élément de jonction top mod.TPA-7)

ES **PLACA RADIANTE SOBRE HORNO ELÉCTRICO MULTIFUNCIONAL CM. 55X37X34H, TEMP: 50÷260°C, CON 1 PARILLA CM.53X32,5 GN1/1 - PUERTA VIDRIO - PLACA CM. 70X50 4 ZONAS (INCLUIDA 1 CHAPA DE CIERRE PARA TOP MOD.TPA-7)**

cm. 80 x 70,5 x 90h

cm. 83 x 77 x 111h / kg 170 / m³ 0,709

15 kW € 6.345,00

400V~3N
50/60 Hz

TUTTAPIASTRA A GAS CON FORNO

EN GAS SOLID TOP WITH OVEN **DE** GAS KOCHPLATTEN MIT ÖFEN **FR** TOUTE PLAQUE A GAZ AVEC FOUR **ES** **PLACA DE COCCIÓN DE GAS CON HORNO**

TPF-78G

08700850



TUTTA PIASTRA SU FORNO GAS STATICO CM. 67X55X34H, TEMP: 150÷300°C, CON 1 GRIGLIA CM.65X53 GN2/1 - PIASTRA CM 77X57 (INCLUSA 1 TESTATA CHIUSURA PIANO MOD.TPA-7)

EN Solid top on Traditional gas-oven cm. 67x55x34h, temp: 150÷300°C, with 1 grid cm.65x53 GN2/1 - Plate cm. 77x57 (included 1 Head end filler strip mod.TPA-7)

DE Kochplatten - Statischer Gas-Backofen cm. 67x55x34h, temp: 150÷300°C, mit 1 Rost cm.65x53 GN2/1 - Platte cm. 77x57 (inbegriffen 1 Abschluss-Element mod.TPA-7)

FR Toute plaque sur Four à gaz statique cm. 67x55x34h, temp: 150÷300°C, avec 1 grille cm.65x53 GN2/1 - Plaque cm. 77x57 (inclus 1 Élément de jonction top mod.TPA-7)

ES **PLACA RADIANTE SOBRE HORNO A GAS ESTÁTICO CM. 67X55X34H, TEMP: 150÷300°C, CON 1 PARILLA CM.65X53 GN2/1 - PLACA CM. 77X57 (INCLUIDA 1 CHAPA DE CIERRE PARA TOP MOD.TPA-7)**

cm. 80 x 70,5 x 90h

cm. 83 x 77 x 111h / kg 169 / m³ 0,709

19,3 kW € 5.112,00

16.600 kcal/h

TPF2-78GP

08720850



TUTTA PIASTRA + 2 FUOCHI SU FORNO GAS STATICO CM. 67X55X34H, TEMP: 150÷300°C, CON 1 GRIGLIA CM.65X53 GN2/1 - PIASTRA CM 37X57 (INCLUSA 1 TESTATA CHIUSURA PIANO MOD.TPA-7)

EN Solid top + 2 burners Traditional gas-oven cm. 67x55x34h, temp: 150÷300°C, with 1 grid cm.65x53 GN2/1 - Plate 37x57cm (included 1 Head end filler strip mod.TPA-7)

DE Kochplatte + 2 Gaskochstellen auf Statischer Gas-Backofen cm. 67x55x34h, temp: 150÷300°C, mit 1 Rost cm.65x53 GN2/1 - Platte 37x57 cm (inbegriffen 1 Abschluss-Element mod.TPA-7)

FR Toute plaque + 2 brûleurs sur Four à gaz statique cm. 67x55x34h, temp: 150÷300°C, avec 1 grille cm.65x53 GN2/1 - Plaque cm. 37x57 (inclus 1 Élément de jonction top mod.TPA-7)

ES **PLACA RADIANTE + 2 FUEGOS SOBRE HORNO A GAS ESTÁTICO CM. 67X55X34H, TEMP: 150÷300°C, CON 1 PARILLA CM.65X53 GN2/1 - PLACA CM 37X57 (INCLUIDA 1 CHAPA DE CIERRE PARA TOP MOD.TPA-7)**

cm. 80 x 70,5 x 90h

cm. 83 x 77 x 111h / kg 165 / m³ 0,709

27,3 kW € 5.490,00

23.478 kcal/h

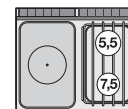
**TPF2-712GPV**

08701251



TUTTA PIASTRA + 2 FUOCHI SU FORNO GAS STATICO CM. 67X55X34H, TEMP: 150÷300°C, CON 1 GRIGLIA CM.65X53 GN2/1 - PIASTRA CM 77X57 - VANO NEUTRO CON PORTA (INCLUSA 1 TESTATA CHIUSURA PIANO MOD.TPA-7)

EN Solid top + 2 burners Traditional gas-oven cm. 67x55x34h, temp: 150÷300°C, with 1 grid cm.65x53 GN2/1 - Plate 77x57cm - Neutral cabinet with door (included 1 Head end filler strip mod.TPA-7)

DE Kochplatte + 2 Gaskochstellen auf Statischer Gas-Backofen cm. 67x55x34h, temp: 150÷300°C, mit 1 Rost cm.65x53 GN2/1 - Platte 77x57 cm - Neutrales Schrankelement mit Tür (inbegriffen 1 Abschluss-Element mod.TPA-7)

FR Toute plaque + 2 brûleurs sur Four à gaz statique cm. 67x55x34h, temp: 150÷300°C, avec 1 grille cm.65x53 GN2/1 - Plaque cm. 77x57 - Element neutre avec porte (inclus 1 Élément de jonction top mod.TPA-7)

ES **PLACA RADIANTE + 2 FUEGOS SOBRE HORNO A GAS ESTÁTICO CM. 67X55X34H, TEMP: 150÷300°C, CON 1 PARILLA CM.65X53 GN2/1 - PLACA CM 77X57 - ARMARIO NEUTRO CON PUERTA (INCLUIDA 1 CHAPA DE CIERRE PARA TOP MOD.TPA-7)**

cm. 120 x 70,5 x 90h

cm. 123 x 77 x 111h / kg 227 / m³ 1,051

32,3 kW € 7.037,00

27.778 kcal/h

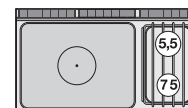

TPF2-712GP

08701250



TUTTA PIASTRA + 2 FUOCHI SU FORNO GAS STATICO CM. 107X55X34H, TEMP: 150÷300°C, CON 1 GRIGLIA CM.105X53 - PIASTRA CM 77X57 (INCLUSA 1 TESTATA CHIUSURA PIANO MOD.TPA-7)

EN Solid top + 2 burners Traditional gas-oven cm. 107x55x34h, temp: 150÷300°C, with 1 grid cm.105x53 - Plate 77x57 (included 1 Head end filler strip mod.TPA-7)

DE Kochplatte + 2 Gaskochstellen auf Statischer Gas-Backofen cm. 107x55x34h, temp: 150÷300°C, mit 1 Rost cm.105x53 - Platte 77x57 (inbegriffen 1 Abschluss-Element mod.TPA-7)

FR Toute plaque + 2 brûleurs sur Four à gaz statique cm. 107x55x34h, temp: 150÷300°C, avec 1 grille cm.105x53 - Plaque cm. 77x57 (inclus 1 Élément de jonction top mod.TPA-7)

ES PLACA RADIANTE + 2 FUEGOS SOBRE HORNO A GAS ESTÁTICO CM. 107X55X34H, TEMP: 150÷300°C, CON 1 PARILLA CM.105X53 - PLACA CM 77X57 (INCLUIDA 1 CHAPA DE CIERRE PARA TOP MOD.TPA-7)

cm. 120 x 70,5 x 90h

cm. 123 x 77 x 111h / kg 209 / m³ 1,051

36 kW
30.960 kcal/h

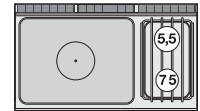
€ 7.545,00

TPF4-712GPV

08721251



TUTTA PIASTRA + 4 FUOCHI SU FORNO GAS STATICO CM. 67X55X34H, TEMP: 150÷300°C, CON 1 GRIGLIA CM.65X53 GN2/1 - PIASTRA CM 37X57 - VANO NEUTRO CON PORTA (INCLUSA 1 TESTATA CHIUSURA PIANO MOD.TPA-7)

EN Solid top + 4 burners Traditional gas-oven cm. 67x55x34h, temp: 150÷300°C, with 1 grid cm.65x53 GN2/1 - Plate 37x57cm - Neutral cabinet with door (included 1 Head end filler strip mod.TPA-7)

DE Kochplatte + 4 Gaskochstellen auf Statischer Gas-Backofen cm. 67x55x34h, temp: 150÷300°C, mit 1 Rost cm.65x53 GN2/1 - Platte 37x57 cm - Neutrales Schrankelement mit Tür (inbegriffen 1 Abschluss-Element mod.TPA-7)

FR Toute plaque + 4 brûleurs sur Four à gaz statique cm. 67x55x34h, temp: 150÷300°C, avec 1 grille cm.65x53 GN2/1 - Plaque cm. 37x57 - Element neutre avec porte (inclus 1 Élément de jonction top mod.TPA-7)

ES PLACA RADIANTE + 4 FUEGOS SOBRE HORNO A GAS ESTÁTICO CM. 67X55X34H, TEMP: 150÷300°C, CON 1 PARILLA CM.65X53 GN2/1 - PLACA CM 37X57 - ARMARIO NEUTRO CON PUERTA (INCLUIDA 1 CHAPA DE CIERRE PARA TOP MOD.TPA-7)

cm. 120 x 70,5 x 90h

cm. 123 x 77 x 111h / kg 221 / m³ 1,051

36,3 kW
31.218 kcal/h

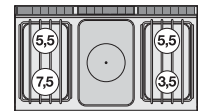
€ 7.034,00

TPF4-712GP

08721250



TUTTA PIASTRA + 4 FUOCHI SU FORNO GAS STATICO CM. 107X55X34H, TEMP: 150÷300°C, CON 1 GRIGLIA CM.105X53 - PIASTRA CM 37X57 (INCLUSA 1 TESTATA CHIUSURA PIANO MOD.TPA-7)

EN Solid top + 4 burners Traditional gas-oven cm. 107x55x34h, temp: 150÷300°C, with 1 grid cm.105x53 - Plate 37x57cm (included 1 Head end filler strip mod.TPA-7)

DE Kochplatte + 4 Gaskochstellen auf Statischer Gas-Backofen cm. 107x55x34h, temp: 150÷300°C, mit 1 Rost cm.105x53 - Platte 37x57 cm (inbegriffen 1 Abschluss-Element mod.TPA-7)

FR Toute plaque + 4 brûleurs sur Four à gaz statique cm. 107x55x34h, temp: 150÷300°C, avec 1 grille cm.105x53 Plaque cm. 37x57 (inclus 1 Élément de jonction top mod.TPA-7)

ES PLACA RADIANTE + 4 FUEGOS SOBRE HORNO A GAS ESTÁTICO CM. 107X55X34H, TEMP: 150÷300°C, CON 1 PARILLA CM.105X53 - PLACA CM 37X57 (INCLUIDA 1 CHAPA DE CIERRE PARA TOP MOD.TPA-7)

cm. 120 x 70,5 x 90h

cm. 123 x 77 x 111h / kg 202 / m³ 1,051

40 kW
34.400 kcal/h

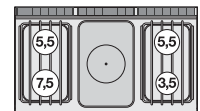
€ 7.892,00

TUTTAPIASTRA A GAS CON FORNO ELETTRICO

EN GAS SOLID TOP WITH ELECTRIC OVEN **DE** GAS KOCHPLATTEN MIT ELEKTRO-ÖFEN **FR** TOUTE PLAQUE A GAZ AVEC FOUR ÉLECTRIQUE
ES PLACA DE COCCIÓN DE GAS CON HORNO ELECTRICO

TPF-78GE

08710860



TUTTA PIASTRA SU FORNO ELETTRICO STATICO CM. 67X55X34H, TEMP: 50÷300°C, CON 1 GRIGLIA CM.65X53 GN2/1 - PIASTRA CM. 77X57 (INCLUSA 1 TESTATA CHIUSURA PIANO MOD.TPA-7)

EN Solid top on traditional electric oven cm. 67x55x34h, temp: 50÷300°C, with 1 grid cm.65x53 GN2/1 - Plate cm. 77x57 (included 1 Head end filler strip mod.TPA-7)

DE Kochplatten - Statischer Elektro-Backofen cm. 67x55x34h, temp: 50÷300°C, mit 1 Rost cm.65x53 GN2/1 - Platte cm. 77x57 (inbegriffen 1 Abschluss-Element mod. TPA-7)

FR Toute plaque sur Four électrique statique cm. 67x55x34h, temp: 50÷300°C, avec 1 grille cm.65x53 GN2/1 - Plaque cm. 77x57 (inclus 1 Élément de jonction top mod. TPA-7)

ES PLACA RADIANTE SOBRE HORNO ELÉCTRICO ESTÁTICO CM. 67X55X34H, TEMP: 50÷300°C, CON 1 PARILLA CM.65X53 GN2/1 - PLACA CM. 77X57 (INCLUIDA 1 CHAPA DE CIERRE PARA TOP MOD.TPA-7)

cm. 80 x 70,5 x 90h

cm. 83 x 77 x 111h / kg 170 / m³ 0,709

12 kW
10.320 kcal/h

€ 5.066,00

5 kW
400V~3N
50/60 Hz

TPFV-78GE

08810860



TUTTA PIASTRA SU FORNO ELETTRICO MULTIFUNZIONE CM. 55X37X34H, TEMP: 50÷260°C, CON 1 GRIGLIA CM.53X32,5 GN1/1 - PORTA INOX - PIASTRA CM. 77X57 (INCLUSA 1 TESTATA CHIUSURA PIANO MOD.TPA-7)

EN Solid top on Multifunction electric oven cm. 55x37x34h, temp: 50÷260°C, with 1 grid cm.53x32,5 GN1/1 - Stainless steel door - Plate cm. 77x57 (included 1 Head end filler strip mod.TPA-7)

DE Kochplatten - Multifunktions-Elektroofen cm. 55x37x34h, temp: 50÷260°C, mit 1 Rost cm.53x32,5 GN1/1 - Edelstahltür - Platte cm. 77x57 (inbegriffen 1 Abschluss-Element mod.TPA-7)

FR Toute plaque sur Four électrique à fonctions multiples cm. 55x37x34h, temp: 50÷260°C, avec 1 grille cm.53x32,5 GN1/1 - Porte acier inoxydable - Plaque cm. 77x57 (inclus 1 Élément de jonction top mod.TPA-7)

ES **PLACA RADIANTE SOBRE HORNO ELÉCTRICO MULTIFUNCIONAL CM. 55X37X34H, TEMP: 50÷260°C, CON 1 PARILLA CM.53X32,5 GN1/1 - PUERTA INOX - PLACA CM. 77X57 (INCLUIDA 1 CHAPA DE CIERRE PARA TOP MOD.TPA-7)**

cm. 80 x 70,5 x 90h

cm. 83 x 77 x 111h / kg 170 / m³ 0,709

12 kW
10.320 kcal/h

€ 5.652,00

5 kW
400V~3N
230V~3
50/60 Hz

TPFV-78GE/V

0881086A



TUTTA PIASTRA SU FORNO ELETTRICO MULTIFUNZIONE CM. 55X37X34H, TEMP: 50÷260°C, CON 1 GRIGLIA CM.53X32,5 GN1/1 - PORTA VETRO - PIASTRA CM. 77X57 (INCLUSA 1 TESTATA CHIUSURA PIANO MOD.TPA-7)

EN Solid top on Multifunction electric oven cm. 55x37x34h, temp: 50÷260°C, with 1 grid cm.53x32,5 GN1/1 - Glass door - Plate cm. 77x57 (included 1 Head end filler strip mod.TPA-7)

DE Kochplatten - Multifunktions-Elektroofen cm. 55x37x34h, temp: 50÷260°C, mit 1 Rost cm.53x32,5 GN1/1 - Glastür - Platte cm. 77x57 (inbegriffen 1 Abschluss-Element mod.TPA-7)

FR Toute plaque sur Four électrique à fonctions multiples cm. 55x37x34h, temp: 50÷260°C, avec 1 grille cm.53x32,5 GN1/1 - Porte vitrée - Plaque cm. 77x57 (inclus 1 Élément de jonction top mod.TPA-7)

ES **PLACA RADIANTE SOBRE HORNO ELÉCTRICO MULTIFUNCIONAL CM. 55X37X34H, TEMP: 50÷260°C, CON 1 PARILLA CM.53X32,5 GN1/1 - PUERTA VIDRIO - PLACA CM. 77X57 (INCLUIDA 1 CHAPA DE CIERRE PARA TOP MOD.TPA-7)**

cm. 80 x 70,5 x 90h

cm. 83 x 77 x 111h / kg 170 / m³ 0,709

12 kW
10.320 kcal/h

€ 5.803,00

5 kW
400V~3N
230V~3
50/60 Hz

TPF2-78GPE

08730860



TUTTA PIASTRA + 2 FUOCHI SU FORNO ELETTRICO STATICO CM. 67X55X34H, TEMP: 50÷300°C, CON 1 GRIGLIA CM.65X53 GN2/1 - PIASTRA CM 37X57 (INCLUSA 1 TESTATA CHIUSURA PIANO MOD.TPA-7)

EN Solid top + 2 burners traditional electric oven cm. 67x55x34h, temp: 50÷300°C, with 1 grid cm.65x53 GN2/1 - Plate 37x57cm (included 1 Head end filler strip mod. TPA-7)

DE Kochplatte + 2 Gaskochstellen auf Statischer Elektro-Backofen cm. 67x55x34h, temp: 50÷300°C, mit 1 Rost cm.65x53 GN2/1 - Platte 37x57 cm (inbegriffen 1 Abschluss-Element mod.TPA-7)

FR Toute plaque + 2 brûleurs sur Four électrique statique cm. 67x55x34h, temp: 50÷300°C, avec 1 grille cm.65x53 GN2/1 - Plaque cm. 37x57 (inclus 1 Élément de jonction top mod.TPA-7)

ES **PLACA RADIANTE + 2 FUEGOS SOBRE HORNO ELÉCTRICO ESTÁTICO CM. 67X55X34H, TEMP: 50÷300°C, CON 1 PARILLA CM.65X53 GN2/1 - PLACA CM 37X57 (INCLUIDA 1 CHAPA DE CIERRE PARA TOP MOD.TPA-7)**

cm. 80 x 70,5 x 90h

cm. 83 x 77 x 111h / kg 166 / m³ 0,709

20 kW
17.200 kcal/h

€ 5.441,00

5 kW
400V~3N
50/60 Hz

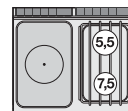
**TPFV2-78GPE**

08810861



TUTTA PIASTRA + 2 FUOCHI SU FORNO ELETTRICO MULTIFUNZIONE CM. 55X37X34H, TEMP: 50÷260°C, CON 1 GRIGLIA CM.53X32,5 GN1/1 - PORTA INOX - PIASTRA CM 37X57 (INCLUSA 1 TESTATA CHIUSURA PIANO MOD.TPA-7)

EN Solid top + 2 burners Multifunction electric oven cm. 55x37x34h, temp: 50÷260°C, with 1 grid cm.53x32,5 GN1/1 - Stainless steel door - Plate 37x57cm (included 1 Head end filler strip mod.TPA-7)

DE Kochplatte + 2 Gaskochstellen auf Multifunktions-Elektroofen cm. 55x37x34h, temp: 50÷260°C, mit 1 Rost cm.53x32,5 GN1/1 - Edelstahltür - Platte 37x57 cm (inbegriffen 1 Abschluss-Element mod.TPA-7)

FR Toute plaque + 2 brûleurs sur Four électrique à fonctions multiples cm. 55x37x34h, temp: 50÷260°C, avec 1 grille cm.53x32,5 GN1/1 - Porte acier inoxydable - Plaque cm. 37x57 (inclus 1 Élément de jonction top mod.TPA-7)

ES **PLACA RADIANTE + 2 FUEGOS SOBRE HORNO ELÉCTRICO MULTIFUNCIONAL CM. 55X37X34H, TEMP: 50÷260°C, CON 1 PARILLA CM.53X32,5 GN1/1 - PUERTA INOX - PLACA CM 37X57 (INCLUIDA 1 CHAPA DE CIERRE PARA TOP MOD.TPA-7)**

cm. 80 x 70,5 x 90h

cm. 83 x 77 x 111h / kg 166 / m³ 0,709

20 kW
17.200 kcal/h

€ 6.011,00

5 kW
400V~3N
230V~3
50/60 Hz

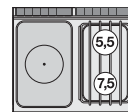

TPFV2-78GPE/V
 0881086B

TUTTA PIASTRA + 2 FUOCHI SU FORNO ELETTRICO MULTIFUNZIONE CM. 55X37X34H, TEMP: 50÷260°C, CON 1 GRIGLIA CM.53X32,5 GN1/1 - PORTA VETRO - PIASTRA CM 37X57 (INCLUSA 1 TESTATA CHIUSURA PIANO MOD.TPA-7)

EN Solid top + 2 burners Multifunction electric oven cm. 55x37x34h, temp: 50÷260°C, with 1 grid cm.53x32,5 GN1/1 - Glass door - Plate 37x57cm (included 1 Head end filler strip mod.TPA-7)

DE Kochplatte + 2 Gaskochstellen auf Multifunktions-Elektroofen cm. 55x37x34h, temp: 50÷260°C, mit 1 Rost cm.53x32,5 GN1/1 - Glastür - Platte 37x57 cm (inbegriffen 1 Abschluss-Element mod.TPA-7)

FR Toute plaque + 2 brûleurs sur Four électrique à fonctions multiples cm. 55x37x34h, temp: 50÷260°C, avec 1 grille cm.53x32,5 GN1/1 - Porte vitrée - Plaque cm. 37x57 (inclus 1 Élément de jonction top mod.TPA-7)

ES **PLACA RADIANTE + 2 FUEGOS SOBRE HORNO ELÉCTRICO MULTIFUNCIONAL CM. 55X37X34H, TEMP: 50÷260°C, CON 1 PARILLA CM.53X32,5 GN1/1 - PUERTA VIDRIO - PLACA CM 37X57 (INCLUIDA 1 CHAPA DE CIERRE PARA TOP MOD.TPA-7)**

cm. 80 x 70,5 x 90h

cm. 83 x 77 x 111h / kg 166 / m³ 0,709

20 kW
17.200 kcal/h

€ 6.162,00

5 kW
400V~3N
230V~3
50/60 Hz

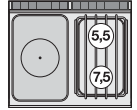
TPF2-712GPEV
 08711261

TUTTA PIASTRA + 2 FUOCHI SU FORNO ELETTRICO STATICO CM. 67X55X34H, TEMP: 50÷300°C, CON 1 GRIGLIA CM.65X53 GN2/1 - PIASTRA CM 77X57 - VANO NEUTRO CON PORTA (INCLUSA 1 TESTATA CHIUSURA PIANO MOD.TPA-7)

EN Solid top + 2 burners traditional electric oven cm. 67x55x34h, temp: 50÷300°C, with 1 grid cm.65x53 GN2/1 - Plate 77x57cm - Neutral cabinet with door (included 1 Head end filler strip mod.TPA-7)

DE Kochplatte + 2 Gaskochstellen auf Statischer Elektro-Backofen cm. 67x55x34h, temp: 50÷300°C, mit 1 Rost cm.65x53 GN2/1 - Platte 77x57 cm - Neutrales Schrankelement mit Tür (inbegriffen 1 Abschluss-Element mod.TPA-7)

FR Toute plaque + 2 brûleurs sur Four électrique statique cm. 67x55x34h, temp: 50÷300°C, avec 1 grille cm.65x53 GN2/1 - Plaque cm. 77x57 - Element neutre avec porte (inclus 1 Élément de jonction top mod.TPA-7)

ES **PLACA RADIANTE + 2 FUEGOS SOBRE HORNO ELÉCTRICO ESTÁTICO CM. 67X55X34H, TEMP: 50÷300°C, CON 1 PARILLA CM.65X53 GN2/1 - PLACA CM 77X57 - ARMARIO NEUTRO CON PUERTA (INCLUIDA 1 CHAPA DE CIERRE PARA TOP MOD.TPA-7)**

cm. 120 x 70,5 x 90h

cm. 123 x 77 x 111h / kg 227 / m³ 1,051

25 kW
21.500 kcal/h

€ 6.974,00

5 kW
400V~3N
50/60 Hz

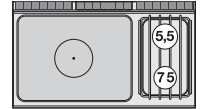
TPFV2-712GPEV
 08811260

TUTTA PIASTRA + 2 FUOCHI SU FORNO ELETTRICO MULTIFUNZIONE CM. 55X37X34H, TEMP: 50÷260°C, CON 1 GRIGLIA CM.53X32,5 GN1/1 - PORTA INOX - PIASTRA CM 77X57 - VANO NEUTRO CON PORTA (INCLUSA 1 TESTATA CHIUSURA PIANO MOD.TPA-7)

EN Solid top + 2 burners Multifunction electric oven cm. 55x37x34h, temp: 50÷260°C, with 1 grid cm.53x32,5 GN1/1 - Stainless steel door - Plate 77x57cm - Neutral cabinet with door (included 1 Head end filler strip mod.TPA-7)

DE Kochplatte + 2 Gaskochstellen auf Multifunktions-Elektroofen cm. 55x37x34h, temp: 50÷260°C, mit 1 Rost cm.53x32,5 GN1/1 - Edelstahltür - Platte 77x57 cm - Neutrales Schrankelement mit Tür (inbegriffen 1 Abschluss-Element mod.TPA-7)

FR Toute plaque + 2 brûleurs sur Four électrique à fonctions multiples cm. 55x37x34h, temp: 50÷260°C, avec 1 grille cm.53x32,5 GN1/1 - Porte acier inoxydable Plaque cm. 77x57 - Element neutre avec porte (inclus 1 Élément de jonction top mod.TPA-7)

ES **PLACA RADIANTE + 2 FUEGOS SOBRE HORNO ELÉCTRICO MULTIFUNCIONAL CM. 55X37X34H, TEMP: 50÷260°C, CON 1 PARILLA CM.53X32,5 GN1/1 - PUERTA INOX - PLACA CM 77X57 - ARMARIO NEUTRO CON PUERTA (INCLUIDA 1 CHAPA DE CIERRE PARA TOP MOD. TPA-7)**

cm. 120 x 70,5 x 90h

cm. 123 x 77 x 111h / kg 227 / m³ 1,051

25 kW
21.500 kcal/h

€ 7.550,00

5 kW
400V~3N
230V~3
50/60 Hz

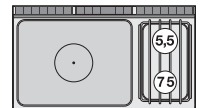
TPFV2-712GPEV/V
 0881126A

TUTTA PIASTRA + 2 FUOCHI SU FORNO ELETTRICO MULTIFUNZIONE CM. 55X37X34H, TEMP: 50÷260°C, CON 1 GRIGLIA CM.53X32,5 GN1/1 - PORTA VETRO - PIASTRA CM 77X57 - VANO NEUTRO CON PORTA (INCLUSA 1 TESTATA CHIUSURA PIANO MOD.TPA-7)

EN Solid top + 2 burners Multifunction electric oven cm. 55x37x34h, temp: 50÷260°C, with 1 grid cm.53x32,5 GN1/1 - Glass door - Plate 77x57cm - Neutral cabinet with door (included 1 Head end filler strip mod.TPA-7)

DE Kochplatte + 2 Gaskochstellen auf Multifunktions-Elektroofen cm. 55x37x34h, temp: 50÷260°C, mit 1 Rost cm.53x32,5 GN1/1 - Glastür - Platte 77x57 cm - Neutrales Schrankelement mit Tür (inbegriffen 1 Abschluss-Element mod.TPA-7)

FR Toute plaque + 2 brûleurs sur Four électrique à fonctions multiples cm. 55x37x34h, temp: 50÷260°C, avec 1 grille cm.53x32,5 GN1/1 - Porte vitrée Plaque cm. 77x57 - Element neutre avec porte (inclus 1 Élément de jonction top mod.TPA-7)

ES **PLACA RADIANTE + 2 FUEGOS SOBRE HORNO ELÉCTRICO MULTIFUNCIONAL CM. 55X37X34H, TEMP: 50÷260°C, CON 1 PARILLA CM.53X32,5 GN1/1 - PUERTA VIDRIO - PLACA CM 77X57 - ARMARIO NEUTRO CON PUERTA (INCLUIDA 1 CHAPA DE CIERRE PARA TOP MOD. TPA-7)**

cm. 120 x 70,5 x 90h

cm. 123 x 77 x 111h / kg 227 / m³ 1,051

25 kW
21.500 kcal/h

€ 7.701,00

5 kW
400V~3N
230V~3
50/60 Hz

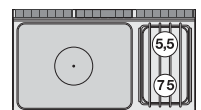

TPF2-712GPE

08711260



TUTTA PIASTRA + 2 FUOCHI SU FORNO ELETTRICO STATICO CM. 107X55X34H, TEMP: 50÷300°C, CON 1 GRIGLIA CM.105X53 - PIASTRA CM 77X57 (INCLUSA 1 TESTATA CHIUSURA PIANO MOD.TPA-7)

EN Solid top + 2 burners traditional electric oven cm. 107x55x34h, temp: 50÷300°C, with 1 grid cm.105x53 - Plate 77x57 (included 1 Head end filler strip mod.TPA-7)

DE Kochplatte + 2 Gaskochstellen auf Statischer Elektro-Backofen cm. 107x55x34h, temp: 50÷300°C, mit 1 Rost cm.105x53 - Platte 77x57 (inbegriffen 1 Abschluss-Element mod.TPA-7)

FR Toute plaque + 2 brûleurs sur Four électrique statique cm. 107x55x34h, temp: 50÷300°C, avec 1 grille cm.105x53 - Plaque cm. 77x57 (inclus 1 Élément de jonction top mod.TPA-7)

ES PLACA RADIANTE + 2 FUEGOS SOBRE HORNO ELÉCTRICO ESTÁTICO CM. 107X55X34H, TEMP: 50÷300°C, CON 1 PARILLA CM.105X53 - PLACA CM 77X57 (INCLUIDA 1 CHAPA DE CIERRE PARA TOP MOD.TPA-7)

cm. 120 x 70,5 x 90h

cm. 123 x 77 x 111h / kg 209 / m³ 1,051

25 kW
21.500 kcal/h

€ 7.478,00

6,9 kW
400V~3N
50/60 Hz

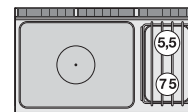
**TPF4-712GPEV**

08731261



TUTTA PIASTRA + 4 FUOCHI SU FORNO ELETTRICO STATICO CM. 67X55X34H, TEMP: 50÷300°C, CON 1 GRIGLIA CM.65X53 GN2/1 - PIASTRA CM 37X57 - VANO NEUTRO CON PORTA (INCLUSA 1 TESTATA CHIUSURA PIANO MOD.TPA-7)

EN Solid top + 4 burners traditional electric oven cm. 67x55x34h, temp: 50÷300°C, with 1 grid cm.65x53 GN2/1 - Plate 37x57cm - Neutral cabinet with door (included 1 Head end filler strip mod.TPA-7)

DE Kochplatte + 4 Gaskochstellen auf Statischer Elektro-Backofen cm. 67x55x34h, temp: 50÷300°C, mit 1 Rost cm.65x53 GN2/1 - Platte 37x57 cm - Neutrales Schrankelement mit Tür (inbegriffen 1 Abschluss-Element mod.TPA-7)

FR Toute plaque + 4 brûleurs sur Four électrique statique cm. 67x55x34h, temp: 50÷300°C, avec 1 grille cm.65x53 GN2/1 - Plaque cm. 37x57 - Element neutre avec porte (inclus 1 Élément de jonction top mod.TPA-7)

ES PLACA RADIANTE + 4 FUEGOS SOBRE HORNO ELÉCTRICO ESTÁTICO CM. 67X55X34H, TEMP: 50÷300°C, CON 1 PARILLA CM.65X53 GN2/1 - PLACA CM 37X57 - ARMARIO NEUTRO CON PUERTA (INCLUIDA 1 CHAPA DE CIERRE PARA TOP MOD.TPA-7)

cm. 120 x 70,5 x 90h

cm. 123 x 77 x 111h / kg 221 / m³ 1,051

29 kW
24.940 kcal/h

€ 6.971,00

5 kW
400V~3N
50/60 Hz

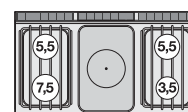
**TPFV4-712GPEV**

08811261



TUTTA PIASTRA + 4 FUOCHI SU FORNO ELETTRICO MULTIFUNZIONE CM. 55X37X34H, TEMP: 50÷260°C, CON 1 GRIGLIA CM.53X32,5 GN1/1 - PORTA INOX - PIASTRA CM 37X57 - VANO NEUTRO CON PORTA (INCLUSA 1 TESTATA CHIUSURA PIANO MOD.TPA-7)

EN Solid top + 4 burners Multifunction electric oven cm. 55x37x34h, temp: 50÷260°C, with 1 grid cm.53x32,5 GN1/1 - Stainless steel door - Plate 37x57cm - Neutral cabinet with door (included 1 Head end filler strip mod.TPA-7)

DE Kochplatte + 4 Gaskochstellen auf Multifunktions-Elektroofen cm. 55x37x34h, temp: 50÷260°C, mit 1 Rost cm.53x32,5 GN1/1 - Edelstahltür - Platte 37x57 cm - Neutrales Schrankelement mit Tür (inbegriffen 1 Abschluss-Element mod.TPA-7)

FR Toute plaque + 4 brûleurs sur Four électrique à fonctions multiples cm. 55x37x34h, temp: 50÷260°C, avec 1 grille cm.53x32,5 GN1/1 - Porte acier inoxydable - Plaque cm. 37x57 - Element neutre avec porte (inclus 1 Élément de jonction top mod.TPA-7)

ES PLACA RADIANTE + 4 FUEGOS SOBRE HORNO ELÉCTRICO MULTIFUNCIONAL CM. 55X37X34H, TEMP: 50÷260°C, CON 1 PARILLA CM.53X32,5 GN1/1 - PUERTA INOX - PLACA CM 37X57 - ARMARIO NEUTRO CON PUERTA (INCLUIDA 1 CHAPA DE CIERRE PARA TOP MOD. TPA-7)

cm. 120 x 70,5 x 90h

cm. 123 x 77 x 111h / kg 221 / m³ 1,051

29 kW
24.940 kcal/h

€ 7.536,00

5 kW
400V~3N
230V~3
50/60 Hz

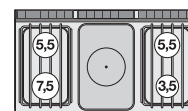
**TPFV4-712GPEV/V**

0881126B



TUTTA PIASTRA + 4 FUOCHI SU FORNO ELETTRICO MULTIFUNZIONE CM. 55X37X34H, TEMP: 50÷260°C, CON 1 GRIGLIA CM.53X32,5 GN1/1 - PORTA VETRO - PIASTRA CM 37X57 - VANO NEUTRO CON PORTA (INCLUSA 1 TESTATA CHIUSURA PIANO MOD.TPA-7)

EN Solid top + 4 burners Multifunction electric oven cm. 55x37x34h, temp: 50÷260°C, with 1 grid cm.53x32,5 GN1/1 - Glass door - Plate 37x57cm - Neutral cabinet with door (included 1 Head end filler strip mod.TPA-7)

DE Kochplatte + 4 Gaskochstellen auf Multifunktions-Elektroofen cm. 55x37x34h, temp: 50÷260°C, mit 1 Rost cm.53x32,5 GN1/1 - Glastür - Platte 37x57 cm - Neutrales Schrankelement mit Tür (inbegriffen 1 Abschluss-Element mod.TPA-7)

FR Toute plaque + 4 brûleurs sur Four électrique à fonctions multiples cm. 55x37x34h, temp: 50÷260°C, avec 1 grille cm.53x32,5 GN1/1 - Porte vitrée - Plaque cm. 37x57 - Element neutre avec porte (inclus 1 Élément de jonction top mod.TPA-7)

ES PLACA RADIANTE + 4 FUEGOS SOBRE HORNO ELÉCTRICO MULTIFUNCIONAL CM. 55X37X34H, TEMP: 50÷260°C, CON 1 PARILLA CM.53X32,5 GN1/1 - PUERTA VIDRIO - PLACA CM 37X57 - ARMARIO NEUTRO CON PUERTA (INCLUIDA 1 CHAPA DE CIERRE PARA TOP MOD. TPA-7)

cm. 120 x 70,5 x 90h

cm. 123 x 77 x 111h / kg 221 / m³ 1,051

29 kW
24.940 kcal/h

€ 7.687,00

5 kW
400V~3N
230V~3
50/60 Hz

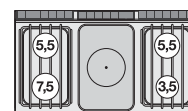

TPF4-712GPE

08731260



TUTTA PIASTRA + 4 FUOCHI SU FORNO ELETTRICO STATICO CM. 107X55X34H, TEMP: 50÷300°C, CON 1 GRIGLIA CM.105X53 - PIASTRA CM 37X57 (INCLUSA 1 TESTATA CHIUSURA PIANO MOD.TPA-7)

EN Solid top + 4 burners traditional electric oven cm. 107x55x34h, temp: 50÷300°C, with 1 grid cm.105x53 - Plate 37x57cm (included 1 Head end filler strip mod.TPA-7)
DE Kochplatte + 4 Gaskochstellen auf Statischer Elektro-Backofen cm. 107x55x34h, temp: 50÷300°C, mit 1 Rost cm.105x53 - Platte 37x57 cm (inbegriffen 1 Abschluss-Element mod.TPA-7)

FR Toute plaque + 4 brûleurs sur Four électrique statique cm. 107x55x34h, temp: 50÷300°C, avec 1 grille cm.105x53 - Plaque cm. 37x57 (inclus 1 Élément de jonction top mod.TPA-7)

ES PLACA RADIANTE + 4 FUEGOS SOBRE HORNO ELÉCTRICO ESTÁTICO CM. 107X55X34H, TEMP: 50÷300°C, CON 1 PARILLA CM.105X53 - PLACA CM 37X57 (INCLUIDA 1 CHAPA DE CIERRE PARA TOP MOD.TPA-7)

cm. 120 x 70,5 x 90h

cm. 123 x 77 x 111h / kg 202 / m³ 1,051

29 kW
24.940 kcal/h

€ 7.821,00

6,9 kW
400V~3N
50/60 Hz

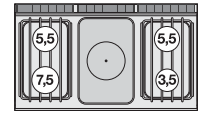
TUTTAPIASTRA ELETTRICO

EN ELECTRIC SOLID TOP **DE** ELEKTRO-KOCHPLATTEN **FR** TOUTE PLAQUE ÉLECTRIQUE **ES** PLACA DE COCCIÓN ELECTRICAS

TP-78ET

08120830



TUTTA PIASTRA SU MOBILE A GIORNO PIASTRA CM. 70X50 - 4 ZONE (INCLUSA 1 TESTATA CHIUSURA PIANO MOD.TPA-7)

EN Solid top on open unit - Plate cm. 70x50 - 4 zones (included 1 Head end filler strip mod.TPA-7)

DE Kochplatten auf offenem Unterbau - Platte cm. 70x50 - 4 zonen (inbegriffen 1 Abschluss-Element mod.TPA-7)

FR Toute plaque sur meuble ouvert - Plaque cm. 70x50 - 4 zones (inclus 1 Élément de jonction top mod.TPA-7)

ES PLACA RADIANTE SOBRE MUEBLE ABIERTO - PLACA CM. 70X50 - 4 ZONAS (INCLUIDA 1 CHAPA DE CIERRE PARA TOP MOD.TPA-7)

cm. 80 x 70,5 x 90h

cm. 83 x 77 x 111h / kg 110 / m³ 0,709

10 kW
400V~3N
50/60 Hz

€ 4.009,00
TUTTOPIANO INDUZIONE

EN INDUCTION SOLID TOP **DE** INDUKTIONNS-KOCHPLATTEN **FR** TOUTE PLAQUE A INDUCTION **ES** PLACA DE COCCIÓN POR INDUCCIÓN

TPI-78ET

08120833



TUTTOPIANO INDUZIONE - VETRO CM.75X57 (INCLUSA 1 TESTATA CHIUSURA PIANO MOD.TPA-7)

EN Induction Solid top - glass cm.75x57 (included 1 Head end filler strip mod.TPA-7)

DE Induktions-Kochplatte - Glas 75x57 cm (inbegriffen 1 Abschluss-Element mod.TPA-7)

FR Toute plaque à induction - Verre cm.75x57 (inclus 1 Élément de jonction top mod. TPA-7)

ES PLACA RADIANTE INDUCCIÓN - VIDRIO CM.75X57 (INCLUIDA 1 CHAPA DE CIERRE PARA TOP MOD.TPA-7)

cm. 80 x 70,5 x 90h

cm. 83 x 77 x 111h / kg 89 / m³ 0,709

21 kW
400V~3
50/60 Hz

€ 20.499,00

TUTTAPIASTRA A GAS

EN GAS SOLID TOP DE GAS KOCHPLATTEN FR TOUTE PLAQUE A GAZ ES PLACA DE COCCIÓN DE GAS

TP-74G

08290450



TUTTA PIASTRA SU MOBILE A GIORNO PIASTRA CM 37X57 (INCLUSA 1 TESTATA CHIUSURA PIANO MOD.TPA-7)

EN Solid top on open unit - Plate 37x57cm (included 1 Head end filler strip mod.TPA-7)

DE Kochplatte auf offenem Unterbau - Platte 37x57 cm (inbegriffen 1 Abschluss-Element mod.TPA-7)

FR Toute plaque sur meuble ouvert - Plaque cm 37x57 (inclus 1 Elément de jonction top mod.TPA-7)

ES **PLACA RADIANTE SOBRE MUEBLE ABIERTO - PLACA CM 37X57 (INCLUIDA 1 CHAPA DE CIERRE PARA TOP MOD.TPA-7)**

cm. 40 x 70,5 x 90h

cm. 43 x 77 x 111h / kg 65 / m³ 0,368

7 kW
6.020 kcal/h

€ 2.392,00

TP-78G

08290850



TUTTA PIASTRA SU MOBILE A GIORNO PIASTRA CM 77X57 (INCLUSA 1 TESTATA CHIUSURA PIANO MOD.TPA-7)

EN Solid top on open unit - Plate 77x57cm (included 1 Head end filler strip mod.TPA-7)

DE Kochplatte auf offenem Unterbau - Platte 77x57 cm (inbegriffen 1 Abschluss-Element mod.TPA-7)

FR Toute plaque sur meuble ouvert - Plaque cm 77x57 (inclus 1 Elément de jonction top mod.TPA-7)

ES **PLACA RADIANTE SOBRE MUEBLE ABIERTO - PLACA CM 77X57 (INCLUIDA 1 CHAPA DE CIERRE PARA TOP MOD.TPA-7)**

cm. 80 x 70,5 x 90h

cm. 83 x 77 x 111h / kg 121 / m³ 0,709

12 kW
10.320 kcal/h

€ 3.254,00

TP2-78GP

08300850



TUTTA PIASTRA + 2 FUOCHI SU MOBILE A GIORNO PIASTRA CM. 37X57 (INCLUSA 1 TESTATA CHIUSURA PIANO MOD.TPA-7)

EN Solid top + 2 burners on open unit Plate 37x57 (included 1 Head end filler strip mod.TPA-7)

DE Kochplatte + 2 Gaskochstellen auf offenem Unterbau Platte 37x57 (inbegriffen 1 Abschluss-Element mod.TPA-7)

FR Toute plaque + 2 brûleurs sur meuble ouvert Plaque cm. 37x57 (inclus 1 Elément de jonction top mod.TPA-7)

ES **PLACA RADIANTE + 2 FUEGOS SOBRE MUEBLE ABIERTO PLACA CM. 37X57 (INCLUIDA 1 CHAPA DE CIERRE PARA TOP MOD.TPA-7)**

cm. 80 x 70,5 x 90h

cm. 83 x 77 x 111h / kg 115 / m³ 0,709

20 kW
17.200 kcal/h

€ 3.750,00

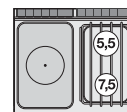

TP2-712GP

08291250



TUTTA PIASTRA + 2 FUOCHI SU MOBILE A GIORNO PIASTRA CM. 77X57 (INCLUSA 1 TESTATA CHIUSURA PIANO MOD.TPA-7)

EN Solid top + 2 burners on open unit Plate 77x57 (included 1 Head end filler strip mod.TPA-7)

DE Kochplatte + 2 Gaskochstellen auf offenem Unterbau Platte 77x57 (inbegriffen 1 Abschluss-Element mod.TPA-7)

FR Toute plaque + 2 brûleurs sur meuble ouvert Plaque cm. 77x57 (inclus 1 Elément de jonction top mod.TPA-7)

ES **PLACA RADIANTE + 2 FUEGOS SOBRE MUEBLE ABIERTO PLACA CM. 77X57 (INCLUIDA 1 CHAPA DE CIERRE PARA TOP MOD.TPA-7)**

cm. 120 x 70,5 x 90h

cm. 123 x 77 x 111h / kg 157 / m³ 1,051

25 kW
21.500 kcal/h

€ 4.844,00

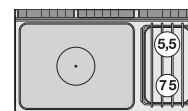

TP4-712GP

08301250



TUTTA PIASTRA + 4 FUOCHI SU MOBILE A GIORNO PIASTRA CM. 37X57 (INCLUSA 1 TESTATA CHIUSURA PIANO MOD.TPA-7)

EN Solid top + 4 burners on open unit Plate 37x57 cm (included 1 Head end filler strip mod.TPA-7)

DE Kochplatte + 4 Gaskochstellen auf offenem Unterbau Platte 37x57 cm (inbegriffen 1 Abschluss-Element mod.TPA-7)

FR Toute plaque + 4 brûleurs sur meuble ouvert Plaque cm. 37x57 (inclus 1 Elément de jonction top mod.TPA-7)

ES **PLACA RADIANTE + 4 FUEGOS SOBRE MUEBLE ABIERTO PLACA CM. 37X57 (INCLUIDA 1 CHAPA DE CIERRE PARA TOP MOD.TPA-7)**

cm. 120 x 70,5 x 90h

cm. 123 x 77 x 111h / kg 154 / m³ 1,051

29 kW
24.940 kcal/h

€ 4.983,00

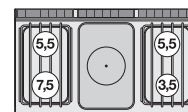

CUOCIPASTA ELETTRICI
EN ELECTRIC PASTA COOKERS DE ELEKTRO NUDELKOCHER FR CUISEURS DE PÂTES ÉLECTRIQUE ES CUECEPASTAS ELECTRICAS
CP-74ET
 08100430

CUOCIPASTA TRIFASE LT. 25 VASCA CM. 30,5X33,5X32,7H. RUBINETTO CARICO ACQUA, SFIORATORE + SCARICO A PAVIMENTO. (CESTI ESCLUSI) (INCLUSA 1 TESTATA CHIUSURA PIANO MOD.TPA-7)

EN Pasta cooker threephase 25 lts. Tank cm. 30,5x33,5x32,7h. Water loading cock + overflow device and floor draining (BASKETS EXCLUDED) (included 1 Head end filler strip mod.TPA-7)

DE Nudelkocher Dreiphasig lt. 25. Becken cm. 30,5x33,5x32,7h. Wasserlauf-Hahn, + Überlauf-Vorrichtung und Ablauf am Boden (KORB AUSGESCHLOSSEN) (inbegriffen 1 Abschluss-Element mod.TPA-7)

FR Cuisneur à pâtes triphase lt. 25. Cuve cm.30,5x33,5x32,7h. Robinet d'arrivée d'eau trop plein + système de vidange au sol (PANIERS EXCLUS) (inclus 1 Élément de jonction top mod.TPA-7)

ES CUECE PASTA TRIFÁSICO. 25 LT. CUBA CM. 30,5X33,5X32,7H. GRIFO CARGA AGUA + VERTEDERO + DESCARGA A PAVIMENTO (CESTAS EXCLUIDAS) (INCLUIDA 1 CHAPA DE CIERRE PARA TOP MOD.TPA-7)

cm. 40 x 70,5 x 90h

 cm. 43 x 77 x 111h / kg 48 / m³ 0,368

 7,8 kW
 400V~3N
 50/60 Hz

€ 3.324,00
COMBINAZIONI

 • Combinations / • Zusammenstellungen
 • Combinaisons / • Combinación múltiple

CPA-74ET
 08100435

CUOCIPASTA TRIFASE LT. 25 VASCA CM. 30,5X33,5X32,7H. CARICO ACQUA AUTOMATICO CON SENSORE DI LIVELLO - SFIORATORE + SCARICO A PAVIMENTO (CESTI ESCLUSI) (INCLUSA 1 TESTATA CHIUSURA PIANO MOD.TPA-7)

EN Pasta cooker threephase 25 lts. Tank cm. 30,5x33,5x32,7h. Automatic Water loading with level sensor - overflow device and floor draining (BASKETS EXCLUDED) (included 1 Head end filler strip mod.TPA-7)

DE Nudelkocher Dreiphasig lt. 25. Becken cm. 30,5x33,5x32,7h. Automatische Wasser Beladung mit Niveauregulierung + Überlauf-Vorrichtung und Ablauf am Boden (KORB AUSGESCHLOSSEN) (inbegriffen 1 Abschluss-Element mod.TPA-7)

FR Cuisneur à pâtes triphase lt. 25. Cuve cm.30,5x33,5x32,7h. Chargement automatique de l'eau avec sensor de niveau, trop plein Système de vidange au sol (PANIERS EXCLUS) (inclus 1 Élément de jonction top mod.TPA-7)

ES CUECE PASTA TRIFÁSICO. 25 LT. CUBA CM. 30,5X33,5X32,7H. CARGA AUTOMÁTICA DE AGUA CON SENSOR DE NIVEL + VERTEDERO + DESCARGA A PAVIMENTO. (CESTAS EXCLUIDAS) (INCLUIDA 1 CHAPA DE CIERRE PARA TOP MOD.TPA-7)

cm. 40 x 70,5 x 90h

 cm. 43 x 77 x 111h / kg 48 / m³ 0,368

 7,8 kW
 400V~3N
 50/60 Hz

€ 3.840,00
COMBINAZIONI

 • Combinations / • Zusammenstellungen
 • Combinaisons / • Combinación múltiple

CP-76ET
 08100630

CUOCIPASTA TRIFASE LT. 40 VASCA CM. 51X30,7X32,7H. RUBINETTO CARICO ACQUA, SFIORATORE + SCARICO A PAVIMENTO. (CESTI ESCLUSI) (INCLUSA 1 TESTATA CHIUSURA PIANO MOD.TPA-7)

- EN** Pasta cooker threephase 40 lts. Tank cm. 51x30,7x32,7h. Water loading cock + overflow device and floor draining (BASKETS EXCLUDED) (included 1 Head end filler strip mod.TPA-7)
- DE** Nudelkocher Dreiphasig lt. 40. Becken cm. 51x30,7x32,7h. Wasserlauf-Hahn, + Überlauf-Vorrichtung und Ablauf am Boden (KORB AUSGESCHLOSSEN) (inbegriffen 1 Abschluss-Element mod.TPA-7)
- FR** Cuiseur à pâtes triphase lt. 40. Cuve cm.51x30,7x32,7h. Robinet d'arrivée d'eau trop plein + système de vidange au sol (PANIERS EXCLUS) (inclus 1 Élément de jonction top mod.TPA-7)
- ES** CUECE PASTA TRIFÁSICO 40 LT. CUBA CM. 51X30,7X32,7H. GRIFO CARGA AGUA + VERTEDERO + DESCARGA A PAVIMENTO (CESTAS EXCLUIDAS) (INCLUIDA 1 CHAPA DE CIERRE PARA TOP MOD.TPA-7)

cm. 60 x 70,5 x 90h

cm. 63 x 77 x 111h / kg 78 / m³ 0,538

13,5 kW
 400V~3N
 50/60 Hz

€ 4.196,00

COMBINAZIONI

- Combinations / • Zusammenstellungen
- Combinaisons / • Combinación múltiple

CPA-76ET
 08100635

CUOCIPASTA TRIFASE LT. 40 VASCA CM. 51X30,7X32,7H. CARICO ACQUA AUTOMATICO CON SENSORE DI LIVELLO - SFIORATORE + SCARICO A PAVIMENTO (CESTI ESCLUSI) (INCLUSA 1 TESTATA CHIUSURA PIANO MOD.TPA-7)

- EN** Pasta cooker threephase 40 lts. Tank cm. 51x30,7x32,7h. Automatic Water loading with level sensor - overflow device and floor draining (BASKETS EXCLUDED) (included 1 Head end filler strip mod.TPA-7)
- DE** Nudelkocher Dreiphasig lt. 40. Becken cm. 51x30,7x32,7h. Automatische Wasser Beladung mit Niveauregulierung + Überlauf-Vorrichtung und Ablauf am Boden (KORB AUSGESCHLOSSEN) (inbegriffen 1 Abschluss-Element mod.TPA-7)
- FR** Cuiseur à pâtes triphase lt. 40. Cuve cm.51x30,7x32,7h. Chargement automatique de l'eau avec sensor de niveau, trop plein Système de vidange au sol (PANIERS EXCLUS) (inclus 1 Élément de jonction top mod.TPA-7)
- ES** CUECE PASTA TRIFÁSICO 40 LT. CUBA CM. 51X30,7X32,7H. CARGA AUTOMÁTICA DE AGUA CON SENSOR DE NIVEL + VERTEDERO + DESCARGA A PAVIMENTO. (CESTAS EXCLUIDAS) (INCLUIDA 1 CHAPA DE CIERRE PARA TOP MOD.TPA-7)

cm. 60 x 70,5 x 90h

cm. 63 x 77 x 111h / kg 78 / m³ 0,538

13,5 kW
 400V~3N
 50/60 Hz

€ 4.713,00

COMBINAZIONI

- Combinations / • Zusammenstellungen
- Combinaisons / • Combinación múltiple



CP-78ET
 08100830

CUOCIPASTA TRIFASE LT. 25+25 2 VASCHE CM. 30,5X33,5X30H. RUBINETTO CARICO ACQUA, SFIORATORE + SCARICO A PAVIMENTO (CESTI ESCLUSI) (INCLUSA 1 TESTATA CHIUSURA PIANO MOD.TPA-7)

15,6 kW
 400V~3N
 50/60 Hz

€ 5.580,00

EN Pasta cooker threephase 25+25 lts. 2 Tanks cm. 30,5x33,5x30h. Water loading cock + overflow device and floor draining (BASKETS EXCLUDED) (included 1 Head end filler strip mod.TPA-7)

DE Nudelkocher dreiphasig lt. 25+25 2 Becken cm. 30,5x33,5x30h. Wasserlauf-Hahn, + Überlauf-Vorrichtung und Ablauf am Boden (KORB AUSGESCHLOSSEN) (inbegriffen 1 Abschluss-Element mod.TPA-7)

FR Cuiseur à pâtes triphase lt. 25+25 2 Cuves cm.30,5x33,5x30h. Robinet d'arrivée d'eau trop plein + système de vidange au sol En (PANIERS EXCLUS) (inclus 1 Élément de jonction top mod.TPA-7)

ES CUECE PASTA TRIFÁSICO. 25+25 LT. 2 CUBAS CM. 30,5X33,5X30H. GRIFO CARGA AGUA + VERTEDERO + DESCARGA A PAVIMENTO (CESTAS EXCLUIDAS) (INCLUIDA 1 CHAPA DE CIERRE PARA TOP MOD.TPA-7)

cm. 80 x 70,5 x 90h

cm. 83 x 77 x 111h / kg 82 / m³ 0,709

COMBINAZIONI

- Combinations / • Zusammenstellungen
- Combinaisons / • Combinación múltiple

CPA-78ET
 08100835

CUOCIPASTA TRIFASE LT. 25+25 2 VASCHE CM. 30,5X33,5X30H. CARICO ACQUA AUTOMATICO CON SENSORE DI LIVELLO - SFIORATORE + SCARICO A PAVIMENTO (CESTI ESCLUSI) (INCLUSA 1 TESTATA CHIUSURA PIANO MOD.TPA-7)

15,6 kW
 400V~3N
 50/60 Hz

€ 6.097,00

EN Pasta cooker threephase 25+25 lts. 2 Tanks cm. 30,5x33,5x30h. Automatic Water loading with level sensor - overflow device and floor draining (BASKETS EXCLUDED) (included 1 Head end filler strip mod.TPA-7)

DE Nudelkocher dreiphasig lt. 25+25 2 Becken cm. 30,5x33,5x30h. Automatische Wasser Beladung mit Niveauregulierung + Überlauf-Vorrichtung und Ablauf am Boden (KORB AUSGESCHLOSSEN) (inbegriffen 1 Abschluss-Element mod.TPA-7)

FR Cuiseur à pâtes triphase lt. 25+25 2 Cuves cm.30,5x33,5x30h. Chargement automatique de l'eau avec sensor de niveau, trop plein Système de vidange au sol (PANIERS EXCLUS) (inclus 1 Élément de jonction top mod.TPA-7)

ES CUECE PASTA TRIFÁSICO. 25+25 LT. 2 CUBAS CM. 30,5X33,5X30H. CARGA AUTOMÁTICA DE AGUA CON SENSOR DE NIVEL + VERTEDERO + DESCARGA A PAVIMENTO. (CESTAS EXCLUIDAS) (INCLUIDA 1 CHAPA DE CIERRE PARA TOP MOD.TPA-7)

cm. 80 x 70,5 x 90h

cm. 83 x 77 x 111h / kg 82 / m³ 0,709

COMBINAZIONI

- Combinations / • Zusammenstellungen
- Combinaisons / • Combinación múltiple



CUOCIPASTA A GAS

EN GAS PASTA COOKERS DE GAS NUDELKOCHER FR CUISEURS DE PÂTES À GAZ ES CUECEPASTAS A GAS

CP-74G
 08270450

CUOCIPASTA GAS LT 25 VASCA CM. 30,5X33,5X32,7H. RUBINETTO CARICO ACQUA, SFIORATORE + SCARICO A PAVIMENTO. (CESTI ESCLUSI) (INCLUSA 1 TESTATA CHIUSURA PIANO MOD.TPA-7)

EN Gas pasta cooker 25 lts. Tank cm. 30,5x33,5x32,7h. Water loading cock + overflow device and floor draining (BASKETS EXCLUDED) (included 1 Head end filler strip mod.TPA-7)

DE Gas-Nudelkocher lt. 25. Becken cm. 30,5x33,5x32,7h. Wasserlauf-Hahn, + Überlauf-Vorrichtung und Ablauf am Boden (KORB AUSGESCHLOSSEN) (inbegriffen 1 Abschluss-Element mod.TPA-7)

FR Cuisneur à pâtes gaz lt. 25. Cuve cm.30,5x33,5x32,7h. Robinet d'arrivée d'eau trop plein + système de vidange au sol (PANIERS EXCLUS) (inclus 1 Élément de jonction top mod.TPA-7)

ES CUECE PASTA GAS 25 LT. CUBA CM. 30,5X33,5X32,7H. GRIFO CARGA AGUA + VERTEDERO + DESCARGA A PAVIMENTO (CESTAS EXCLUIDAS) (INCLUIDA 1 CHAPA DE CIERRE PARA TOP MOD.TPA-7)

cm. 40 x 70,5 x 90h

 cm. 43 x 77 x 111h / kg 61 / m³ 0,368

 9,5 kW
 8.160 kcal/h

€ 3.954,00

 0,02 KW
 230V~
 50/60 Hz

COMBINAZIONI

- Combinations / • Zusammenstellungen
- Combinaisons / • Combinación múltiple

CPA-74G
 08270455

CUOCIPASTA GAS LT 25 VASCA CM. 30,5X33,5X32,7H. CARICO ACQUA AUTOMATICO CON SENSORE DI LIVELLO - SFIORATORE + SCARICO A PAVIMENTO (CESTI ESCLUSI) (INCLUSA 1 TESTATA CHIUSURA PIANO MOD.TPA-7)

EN Gas pasta cooker 25 lts. Tank cm. 30,5x33,5x32,7h. Automatic Water loading with level sensor - overflow device and floor draining (BASKETS EXCLUDED) (included 1 Head end filler strip mod.TPA-7)

DE Gas-Nudelkocher lt. 25. Becken cm. 30,5x33,5x32,7h. Automatische Wasser Beladung mit Niveauregulierung + Überlauf-Vorrichtung und Ablauf am Boden (KORB AUSGESCHLOSSEN) (inbegriffen 1 Abschluss-Element mod.TPA-7)

FR Cuisneur à pâtes gaz lt. 25. Cuve cm.30,5x33,5x32,7h. Chargement automatique de l'eau avec sensor de niveau, trop plein Système de vidange au sol (PANIERS EXCLUS) (inclus 1 Élément de jonction top mod.TPA-7)

ES CUECE PASTA GAS 25 LT. CUBA CM. 30,5X33,5X32,7H. CARGA AUTOMÁTICA DE AGUA CON SENSOR DE NIVEL + VERTEDERO + DESCARGA A PAVIMENTO. (CESTAS EXCLUIDAS) (INCLUIDA 1 CHAPA DE CIERRE PARA TOP MOD.TPA-7)

cm. 40 x 70,5 x 90h

 cm. 43 x 77 x 111h / kg 61 / m³ 0,368

 9,5 kW
 8.160 kcal/h

€ 4.249,00

 0,035 KW
 230V~
 50/60 Hz

COMBINAZIONI

- Combinations / • Zusammenstellungen
- Combinaisons / • Combinación múltiple



CP-76G
 08270650

CUOCIPASTA GAS LT 40 VASCA CM. 51X30,7X32,7H. RUBINETTO CARICO ACQUA, SFIORATORE + SCARICO A PAVIMENTO. (CESTI ESCLUSI) (INCLUSA 1 TESTATA CHIUSURA PIANO MOD.TPA-7)

13,95 kW
11.997 kcal/h

€ 4.296,00

EN Gas pasta cooker 40 lts. Tank cm. 51x30,7x32,7h. Water loading cock + overflow device and floor draining (BASKETS EXCLUDED) (included 1 Head end filler strip mod.TPA-7)

0,02 KW
230V~
50/60 Hz

DE Gas-Nudelkocher lt. 40. Becken cm. 51x30,7x32,7h. Wasserlauf-Hahn, + Überlauf-Vorrichtung und Ablauf am Boden (KORB AUSGESCHLOSSEN) (inbegriffen 1 Abschluss-Element mod.TPA-7)

FR Cuiseur à pâtes gaz lt. 40. Cuve cm.51x30,7x32,7h. Robinet d'arrivée d'eau trop plein + système de vidange au sol (PANIERS EXCLUS) (inclus 1 Élément de jonction top mod.TPA-7)

ES CUECE PASTA GAS 40 LT. CUBA CM. 51X30,7X32,7H. GRIFO CARGA AGUA + VERTEDERO + DESCARGA A PAVIMENTO (CESTAS EXCLUIDAS) (INCLUIDA 1 CHAPA DE CIERRE PARA TOP MOD.TPA-7)

cm. 60 x 70,5 x 90h

cm. 63 x 77 x 111h / kg 80 / m³ 0,538

COMBINAZIONI

- Combinations / • Zusammenstellungen
- Combinaisons / • Combinación múltiple

CPA-76G
 08270655

CUOCIPASTA GAS LT 40 VASCA CM. 51X30,7X32,7H. CARICO ACQUA AUTOMATICO CON SENSORE DI LIVELLO - SFIORATORE + SCARICO A PAVIMENTO (CESTI ESCLUSI) (INCLUSA 1 TESTATA CHIUSURA PIANO MOD.TPA-7)

13,95 kW
11.997 kcal/h

€ 4.591,00

EN Gas pasta cooker 40 lts. Tank cm. 51x30,7x32,7h. Automatic Water loading with level sensor - overflow device and floor draining (BASKETS EXCLUDED) (included 1 Head end filler strip mod.TPA-7)

0,035 KW
230V~
50/60 Hz

DE Gas-Nudelkocher lt. 40. Becken cm. 51x30,7x32,7h. Automatische Wasser Beladung mit Niveauregulierung + Überlauf-Vorrichtung und Ablauf am Boden (KORB AUSGESCHLOSSEN) (inbegriffen 1 Abschluss-Element mod.TPA-7)

FR Cuiseur à pâtes gaz lt. 40. Cuve cm.51x30,7x32,7h. Chargement automatique de l'eau avec sensor de niveau, trop plein Système de vidange au sol (PANIERS EXCLUS) (inclus 1 Élément de jonction top mod.TPA-7)

ES CUECE PASTA GAS 40 LT. CUBA CM. 51X30,7X32,7H. CARGA AUTOMÁTICA DE AGUA CON SENSOR DE NIVEL + VERTEDERO + DESCARGA A PAVIMENTO. (CESTAS EXCLUIDAS) (INCLUIDA 1 CHAPA DE CIERRE PARA TOP MOD.TPA-7)

cm. 60 x 70,5 x 90h

cm. 63 x 77 x 111h / kg 80 / m³ 0,538

COMBINAZIONI

- Combinations / • Zusammenstellungen
- Combinaisons / • Combinación múltiple



CP-78G

08270850



CUOCIPASTA GAS LT. 25+25 2 VASCHE CM. 30,5X33,5X32,7H. RUBINETTO CARICO ACQUA, SFIORATORE + SCARICO A PAVIMENTO (CESTI ESCLUSI) (INCLUSA 1 TESTATA CHIUSURA PIANO MOD.TPA-7)

EN Gas pasta cooker 25+25 lts. 2 Tanks cm. 30,5x33,5x32,7h. Water loading cock + overflow device and floor draining. (BASKETS EXCLUDED) (included 1 Head end filler strip mod.TPA-7)

DE Gas-Nudelkocher lt. 25+25 2 Becken cm. 30,5x33,5x32,7h. Wasserlauf-Hahn, + Überlauf-Vorrichtung und Ablauf am Boden (KORB AUSGESCHLOSSEN) (inbegriffen 1 Abschluss-Element mod.TPA-7)

FR Cuiseur à pâtes gaz lt. 25+25 2 Cuves cm.30,5x33,5x32,7h. robinet d'arrivée d'eau trop plein + système de vidange au sol (PANIERES EXCLUS) (inclus 1 Élément de jonction top mod.TPA-7)

ES CUECE PASTA GAS 25+25 LT. 2 CUBAS CM. 30,5X33,5X32,7H. GRIFO CARGA AGUA + VERTEDERO + DESCARGA A PAVIMENTO (CESTAS EXCLUIDAS) (INCLUIDA 1 CHAPA DE CIERRE PARA TOP MOD.TPA-7)

cm. 80 x 70,5 x 90h

cm. 83 x 77 x 111h / kg 103 / m³ 0,709

19 kW
16.320 kcal/h

€ 6.186,00

0,04 KW
230V~
50/60 Hz

COMBINAZIONI

- Combinations / • Zusammenstellungen
- Combinaisons / • Combinación múltiple

**CPA-78G**

08270855



CUOCIPASTA GAS LT. 25+25 2 VASCHE CM. 30,5X33,5X32,7H. CARICO ACQUA AUTOMATICO CON SENSORE DI LIVELLO - SFIORATORE + SCARICO A PAVIMENTO (CESTI ESCLUSI) (INCLUSA 1 TESTATA CHIUSURA PIANO MOD.TPA-7)

EN Gas pasta cooker 25+25 lts. 2 Tanks cm. 30,5x33,5x32,7h. Automatic Water loading with level sensor - overflow device and floor draining (BASKETS EXCLUDED) (included 1 Head end filler strip mod.TPA-7)

DE Gas-Nudelkocher lt. 25+25 2 Becken cm. 30,5x33,5x32,7h. Automatische Wasser Beladung mit Niveauregulierung + Überlauf-Vorrichtung und Ablauf am Boden (KORB AUSGESCHLOSSEN) (inbegriffen 1 Abschluss-Element mod.TPA-7)

FR Cuiseur à pâtes gaz lt. 25+25 2 Cuves cm.30,5x33,5x32,7h. Chargement automatique de l'eau avec sensor de niveau, trop plein Système de vidange au sol (PANIERES EXCLUS) (inclus 1 Élément de jonction top mod.TPA-7)

ES CUECE PASTA GAS 25+25 LT. 2 CUBAS CM. 30,5X33,5X32,7H. CARGA AUTOMÁTICA DE AGUA CON SENSOR DE NIVEL + VERTEDERO + DESCARGA A PAVIMENTO. (CESTAS EXCLUIDAS) (INCLUIDA 1 CHAPA DE CIERRE PARA TOP MOD.TPA-7)

cm. 80 x 70,5 x 90h

cm. 83 x 77 x 111h / kg 103 / m³ 0,709

19 kW
16.320 kcal/h

€ 6.778,00

0,07 KW
230V~
50/60 Hz

COMBINAZIONI

- Combinations / • Zusammenstellungen
- Combinaisons / • Combinación múltiple



SOLLEVATORE CESTI
EN BASKET ELEVATOR DE HEBEN KORBE FR SOULEVER DES PANIERS ES LEVANTE CESTAS
SCCP-72EM
08140210

SOLLEVATORE CESTI DA AFFIANCARE AI CUOCIPASTA CP-74/78, SOLLEVAMENTO AUTOMATICO TEMPORIZZATO O MANUALE, 2 ASTE (INCLUSA 1 TESTATA CHIUSURA PIANO MOD.TPA-7)

- EN** basket elevator for pasta cooker CP-74/78, automatic timed or manual lifting, 2 rods (included 1 Head end filler strip mod.TPA-7)
- DE** heben Korbe für Nudelkocher CP-74/78, Timed oder manuelle Heben, 2 Stangen (inbegriffen 1 Abschluss-Element mod.TPA-7)
- FR** soulever des paniers pour cuiseur a patés CP-74/78, soulèvement temporisé ou manuel, 2 tiges (inclus 1 Élément de jonction top mod.TPA-7)
- ES** **LEVANTE CESTAS PARA CUECE PASTA CP-74/78, ELEVACIÓN TEMPORIZADO O MANUAL, 2 BARRAS (INCLUIDA 1 CHAPA DE CIERRE PARA TOP MOD.TPA-7)**

cm. 20 x 70,5 x 90h
 cm. 43 x 77 x 111h / kg 45 / m³ 0,368

0,35 kW
 230V~
 50/60 Hz
€ 3.620,00

COMBINAZIONI

- Combinations / • Zusammenstellungen
- Combinaisons / • Combinación múltiple

BAGNOMARIA ELETTRICI
EN ELECTRIC BAIN MARIE DE ELEKTRO WASSERBÄDER FR BAIN MARIE ÉLECTRIQUE ES BAÑO MARÍA ELECTRICO
BM-74EM
08050410

BAGNOMARIA MONOFASE SU MOBILE A GIORNO VASCA PER GN 1/1 H.15, RUBINETTO CARICO ACQUA, SCARICO A PAVIMENTO (INCLUSA 1 TESTATA CHIUSURA PIANO MOD. TPA-7)

- EN** Bain marie singlephase on open cabinet - Bowl for GN 1/1 h.15, water loading cock, floor draining (included 1 Head end filler strip mod.TPA-7)
- DE** Wasserbäder einphasig mit offenem Unterbau - Becken GN 1/1 h.15, Wasserlauf-Hahn, Ablauf am Boden (inbegriffen 1 Abschluss-Element mod.TPA-7)
- FR** Bain marie monophasé sur armoire ouvert - Cuve GN 1/1 h.15 - Robinet d'arrivée d'eau, système de vidange au sol (inclus 1 Élément de jonction top mod.TPA-7)
- ES** **BAÑO DE MARÍA MONOFÁSICO SOBRE MUEBLE ABIERTO CUBA PARA GN 1/1 15H - GRIFO CARGA AGUA, DESCARGA A PAVIMENTO (INCLUIDA 1 CHAPA DE CIERRE PARA TOP MOD.TPA-7)**

cm. 40 x 70,5 x 90h
 cm. 43 x 77 x 111h / kg 41 / m³ 0,368

2,1 kW
 230V~
 50/60 Hz
€ 1.938,00

BM-78ET
08050830

BAGNOMARIA TRIFASE SU MOBILE A GIORNO VASCA PER GN 2/1 15H, RUBINETTO CARICO ACQUA, SCARICO A PAVIMENTO (INCLUSA 1 TESTATA CHIUSURA PIANO MOD. TPA-7)

- EN** Bain marie threephase on open cabinet - Bowl for GN 2/1 15h, water loading cock, floor draining (included 1 Head end filler strip mod.TPA-7)
- DE** Wasserbäder Dreiphasig mit offenem Unterbau - Becken GN 2/1 15h, Wasserlauf-Hahn, Ablauf am Boden (inbegriffen 1 Abschluss-Element mod.TPA-7)
- FR** Bain marie triphasé sur armoire ouvert Cuve GN 2/1 15h, Robinet d'arrivée d'eau, système de vidange au sol (inclus 1 Élément de jonction top mod.TPA-7)
- ES** **BAÑO DE MARÍA TRIFÁSICO. SOBRE MUEBLE ABIERTO CUBA PARA GN 2/1 15H, GRIFO CARGA AGUA, DESCARGA A PAVIMENTO (INCLUIDA 1 CHAPA DE CIERRE PARA TOP MOD.TPA-7)**

cm. 80 x 70,5 x 90h
 cm. 83 x 77 x 111h / kg 61 / m³ 0,709

4,2 kW
 400V~2N
 230V~3
 230V~
 50/60 Hz
€ 2.741,00

BAGNOMARIA A GAS

EN GAS BAIN MARIE DE GAS WASSERBÄDER FR BAIN MARIE A GAZ ES BAÑO MARÍA DE GAS

BM-74G

08220450



BAGNOMARIA GAS SU MOBILE A GIORNO VASCA PER GN 1/1 H.15, RUBINETTO CARICO ACQUA, SCARICO A PAVIMENTO (INCLUSA 1 TESTATA CHIUSURA PIANO MOD.TPA-7)

EN Gas bain marie on open cabinet - Bowl for GN 1/1 h.15, water loading cock, floor draining (included 1 Head end filler strip mod.TPA-7)

DE Gas Wasserbad mit offenem Unterbau - Becken GN 1/1 h.15, Wasserlauf-Hahn, Ablauf am Boden. (inbegriffen 1 Abschluss-Element mod.TPA-7)

FR Bain-marie gaz sur armoire ouvert Cuve pour GN 1/1 h.15 - Robinet d'arrivée d'eau, système de vidange au sol (inclus 1 Élément de jonction top mod.TPA-7)

ES BAÑO DE MARÍA GAS SOBRE MUEBLE ABIERTO - CUBA PARA GN 1/1 15H, GRIFO CARGA AGUA, DESCARGA A PAVIMENTO (INCLUIDA 1 CHAPA DE CIERRE PARA TOP MOD.TPA-7)

cm. 40 x 70,5 x 90h

cm. 43 x 77 x 111h / kg 49 / m³ 0,368

3,5 kW
3.010 kcal/h

€ 2.021,00

BM-78G

08220850



BAGNOMARIA GAS SU MOBILE A GIORNO VASCA PER GN 2/1 H.15, RUBINETTO CARICO ACQUA, SCARICO A PAVIMENTO. (INCLUSA 1 TESTATA CHIUSURA PIANO MOD.TPA-7)

EN Gas bain marie on open cabinet. Bowl for GN 2/1 h.15, water loading cock, floor draining (included 1 Head end filler strip mod.TPA-7)

DE Gas Wasserbad mit offenem Unterbau. Becken GN 2/1 h.15, Wasserlauf-Hahn, Ablauf am Boden. (inbegriffen 1 Abschluss-Element mod.TPA-7)

FR Bain-marie gaz sur armoire ouvert. Cuve pour GN 2/1 h.15, robinet d'arrivée d'eau, système de vidange au sol (inclus 1 Élément de jonction top mod.TPA-7)

ES BAÑO DE MARÍA GAS SOBRE MUEBLE ABIERTO. CUBA PARA GN 2/1 15H, GRIFO CARGA AGUA, DESCARGA A PAVIMENTO. (INCLUIDA 1 CHAPA DE CIERRE PARA TOP MOD.TPA-7)

cm. 80 x 70,5 x 90h

cm. 83 x 77 x 111h / kg 68 / m³ 0,709

6,5 kW
5.590 kcal/h

€ 3.158,00

CONTENITORE CALDO INFRAROSSO

EN ELECTRIC CHIP DUMP WITH INFRARED HEATER DE FRITTENWANNE MIT INFRAROT FR SILO A FRITES AVEC INFRAROUGE ES CONTENEDOR CALIENTE POR INFRARROJO

BS-74EM

08040410



CONTENITORE CALDO CON INFRAROSSO, MONOFASE SU MOBILE A GIORNO VASCA CM. 30,5X51X16,5H CON FALSO FONDO FORATO (INCLUSA 1 TESTATA CHIUSURA PIANO MOD.TPA-7)

EN Fry dump singlephase with infra-red heater on open cabinet. Bowl cm. 30,5x51x16,5h with perforated double bottom (included 1 Head end filler strip mod. TPA-7)

DE Frittenwanne Einphasig mit Infrarot-strahler mit offenem Unterbau. Becke cm. 30,5x51x16,5h mit gelochtem Bodenrost (inbegriffen 1 Abschluss-Element mod. TPA-7)

FR Silo a frites monophasé avec infrarouge sur armoire ouvert. Cuve cm 30,5x51x16,5h avec double-fond perforé. (inclus 1 Élément de jonction top mod.TPA-7)

ES CONTENEDOR CALIENTE POR INFRARROJO, MONOFÁSICO Y SOBRE MUEBLE ABIERTO. CUBA CM. 30,5X51X16,5H CON FALSO FONDO AGUJEREO (INCLUIDA 1 CHAPA DE CIERRE PARA TOP MOD.TPA-7)

cm. 40 x 70,5 x 90h

cm. 43 x 77 x 122h / kg 42 / m³ 0,404

1,47 kW
230V~
50/60 Hz

€ 2.214,00

FRY-TOP ELETTRICI
EN ELECTRIC GRIDDLE DE ELEKTROGRIDDLEPLATTEN FR FRY-TOP ÉLECTRIQUE ES FRY-TOP ELECTRICO
FTL-74ET
08060431

FRY-TOP ELETTRICO LISCIO, SU MOBILE A GIORNO, PIASTRA CM.36X51 (INCLUSA 1 TESTATA CHIUSURA PIANO MOD.TPA-7)

- EN** Electric Fry-top smooth griddle, on open cabinet, plate cm.36x51 (included 1 Head end filler strip mod.TPA-7)
- DE** Griddleplatte elektrische glatt, mit offenem Unterbau, platte cm.36x51 (inbegriffen 1 Abschluss-Element mod.TPA-7)
- FR** Plaque électriques lisse, sur armoire ouvert, plaque cm.36x51 (inclus 1 Élément de jonction top mod.TPA-7)
- ES** **FRY-TOP ELÉCTRICO LISO, SOBRE MUEBLE ABIERTO, PLANCHA CM.36X51 (INCLUIDA 1 CHAPA DE CIERRE PARA TOP MOD.TPA-7)**

cm. 40 x 70,5 x 90h
 cm. 43 x 77 x 111h / kg 64 / m³ 0,368

€ 2.392,00
 ⚡ 5,55 kW
 400V~3N
 230V~3
 50/60 Hz

FTL-74ETS
08060434

FRY-TOP ELETTRICO LISCIO CROMATO SUPERCHROME (MOCA APPROVED), SU MOBILE A GIORNO, PIASTRA CM.36X51 (INCLUSA 1 TESTATA CHIUSURA PIANO MOD.TPA-7)

- EN** Electric Fry-top smooth chromed griddle SUPERCHROME (Moca Approved), on open cabinet, plate cm.36x51 (included 1 Head end filler strip mod.TPA-7)
- DE** Griddleplatte elektrische glatt hartverchromt SUPERCHROME (Moca Approved), mit offenem Unterbau, platte cm.36x51 (inbegriffen 1 Abschluss-Element mod.TPA-7)
- FR** Plaque électriques lisse chromée SUPERCHROME (Moca Approved), sur armoire ouvert, plaque cm.36x51 (inclus 1 Élément de jonction top mod.TPA-7)
- ES** **FRY-TOP ELÉCTRICO LISO CROMADO SUPERCHROME (MOCA APPROVED), SOBRE MUEBLE ABIERTO, PLANCHA CM.36X51 (INCLUIDA 1 CHAPA DE CIERRE PARA TOP MOD.TPA-7)**

cm. 40 x 70,5 x 90h
 cm. 43 x 77 x 111h / kg 64 / m³ 0,368

€ 2.852,00
 ⚡ 5,55 kW
 400V~3N
 230V~3
 50/60 Hz

FTL-74ETSS
08060430

FRY-TOP ELETTRICO LISCIO CROMO LUCIDO, SU MOBILE A GIORNO, PIASTRA CM.36X51 (INCLUSA 1 TESTATA CHIUSURA PIANO MOD.TPA-7)

- EN** Electric Fry-top smooth POLISHED CHROME, on open cabinet, plate cm.36x51 (included 1 Head end filler strip mod.TPA-7)
- DE** Griddleplatte elektrische glatt POLIERTEM CHROM, mit offenem Unterbau, platte cm.36x51 (inbegriffen 1 Abschluss-Element mod.TPA-7)
- FR** Plaque électriques lisse CHROME POLI, sur armoire ouvert, plaque cm.36x51 (inclus 1 Élément de jonction top mod.TPA-7)
- ES** **FRY-TOP ELÉCTRICO LISO CROMO PULIDO, SOBRE MUEBLE ABIERTO, PLANCHA CM.36X51 (INCLUIDA 1 CHAPA DE CIERRE PARA TOP MOD.TPA-7)**

cm. 40 x 70,5 x 90h
 cm. 43 x 77 x 111h / kg 64 / m³ 0,368

€ 2.852,00
 ⚡ 5,55 kW
 400V~3N
 230V~3
 50/60 Hz

FTR-74ET
08060433

FRY-TOP ELETTRICO RIGATO, SU MOBILE A GIORNO, PIASTRA CM.36X51 (INCLUSA 1 TESTATA CHIUSURA PIANO MOD.TPA-7)

- EN** Electric Fry-top grooved griddle, on open cabinet, plate cm.36x51 (included 1 Head end filler strip mod.TPA-7)
- DE** Griddleplatte elektrische gerillt, mit offenem Unterbau, platte cm.36x51 (inbegriffen 1 Abschluss-Element mod.TPA-7)
- FR** Plaque électriques nervurée, sur armoire ouvert, plaque cm.36x51 (inclus 1 Élément de jonction top mod.TPA-7)
- ES** **FRY-TOP ELÉCTRICO ESTRIADO, SOBRE MUEBLE ABIERTO, PLANCHA CM.36X51 (INCLUIDA 1 CHAPA DE CIERRE PARA TOP MOD.TPA-7)**

cm. 40 x 70,5 x 90h
 cm. 43 x 77 x 111h / kg 64 / m³ 0,368

€ 2.552,00
 ⚡ 5,55 kW
 400V~3N
 230V~3
 50/60 Hz

FTR-74ETS
08060436

FRY-TOP ELETTRICO RIGATO CROMATO SUPERCHROME (MOCA APPROVED), SU MOBILE A GIORNO, PIASTRA CM.36X51 (INCLUSA 1 TESTATA CHIUSURA PIANO MOD.TPA-7)

- EN** Electric Fry-top grooved chromed griddle SUPERCHROME (Moca Approved), on open cabinet, plate cm.36x51 (included 1 Head end filler strip mod.TPA-7)
- DE** Griddleplatte elektrische gerillt hartverchromt SUPERCHROME (Moca Approved), mit offenem Unterbau, platte cm.36x51 (inbegriffen 1 Abschluss-Element mod.TPA-7)
- FR** Plaque électriques nervurée chromée SUPERCHROME (Moca Approved), sur armoire ouvert, plaque cm.36x51 (inclus 1 Élément de jonction top mod.TPA-7)
- ES** **FRY-TOP ELÉCTRICO ESTRIADO CROMADO SUPERCHROME (MOCA APPROVED), SOBRE MUEBLE ABIERTO, PLANCHA CM.36X51 (INCLUIDA 1 CHAPA DE CIERRE PARA TOP MOD.TPA-7)**

cm. 40 x 70,5 x 90h
 cm. 43 x 77 x 111h / kg 64 / m³ 0,368

€ 2.953,00
 ⚡ 5,55 kW
 400V~3N
 230V~3
 50/60 Hz

FTL-76ET

08060631



FRY-TOP ELETTRICO LISCIO, SU MOBILE A GIORNO, PIASTRA CM.56X51 (INCLUSA 1 TESTATA CHIUSURA PIANO MOD.TPA-7)

EN Electric Fry-top smooth griddle, on open cabinet, plate cm.56x51 (included 1 Head end filler strip mod.TPA-7)

DE Griddleplatte elektrische glatt, mit offenem Unterbau, platte cm.56x51 (inbegriffen 1 Abschluss-Element mod.TPA-7)

FR Plaque électriques lisse, sur armoire ouvert, plaque cm.56x51 (inclus 1 Elément de jonction top mod.TPA-7)

ES **FRY-TOP ELÉCTRICO LISO, SOBRE MUEBLE ABIERTO, PLANCHA CM.56X51 (INCLUIDA 1 CHAPA DE CIERRE PARA TOP MOD.TPA-7)**

cm. 60 x 70,5 x 90h

cm. 63 x 77 x 111h / kg 78 / m³ 0,538

7,4 kW
400V~3N
50/60 Hz

€ 2.889,00**FTL-76ETS**

08060634

FRY-TOP ELETTRICO LISCIO CROMATO SUPERCHROME (MOCA APPROVED), SU MOBILE A GIORNO, PIASTRA CM.56X51 (INCLUSA 1 TESTATA CHIUSURA PIANO MOD.TPA-7)

EN Electric Fry-top smooth chromed griddle SUPERCHROME (Moca Approved), on open cabinet, plate cm.56x51 (included 1 Head end filler strip mod.TPA-7)

DE Griddleplatte elektrische glatt hartverchromt SUPERCHROME (Moca Approved), mit offenem Unterbau, platte cm.56x51 (inbegriffen 1 Abschluss-Element mod.TPA-7)

FR Plaque électriques lisse chromée SUPERCHROME (Moca Approved), sur armoire ouvert, plaque cm.56x51 (inclus 1 Elément de jonction top mod.TPA-7)

ES **FRY-TOP ELÉCTRICO LISO CROMADO SUPERCHROME (MOCA APPROVED), SOBRE MUEBLE ABIERTO, PLANCHA CM.56X51 (INCLUIDA 1 CHAPA DE CIERRE PARA TOP MOD.TPA-7)**

cm. 60 x 70,5 x 90h

cm. 63 x 77 x 111h / kg 78 / m³ 0,538

7,4 kW
400V~3N
50/60 Hz

€ 3.366,00**FTL-76ETSS**

08060630

FRY-TOP ELETTRICO LISCIO CROMO LUCIDO, SU MOBILE A GIORNO, PIASTRA CM.56X51 (INCLUSA 1 TESTATA CHIUSURA PIANO MOD.TPA-7)

EN Electric Fry-top smooth POLISHED CHROME, on open cabinet, plate cm.56x51 (included 1 Head end filler strip mod.TPA-7)

DE Griddleplatte elektrische glatt POLIERTEM CHROM, mit offenem Unterbau, platte cm.56x51 (inbegriffen 1 Abschluss-Element mod.TPA-7)

FR Plaque électriques lisse CHROME POLI, sur armoire ouvert, plaque cm.56x51 (inclus 1 Elément de jonction top mod.TPA-7)

ES **FRY-TOP ELÉCTRICO LISO CROMO PULIDO, SOBRE MUEBLE ABIERTO, PLANCHA CM.56X51 (INCLUIDA 1 CHAPA DE CIERRE PARA TOP MOD.TPA-7)**

cm. 60 x 70,5 x 90h

cm. 63 x 77 x 111h / kg 78 / m³ 0,538

7,4 kW
400V~3N
50/60 Hz

€ 3.366,00**FTLR-76ET**

08060632



FRY-TOP ELETTRICO 1/2 RIGATO + 1/2 LISCIO, SU MOBILE A GIORNO, PIASTRA CM.56X51 (INCLUSA 1 TESTATA CHIUSURA PIANO MOD.TPA-7)

EN Electric Fry-top 1/2 grooved + 1/2 smooth, on open cabinet, plate cm.56x51 (included 1 Head end filler strip mod.TPA-7)

DE Griddleplatte elektrische 1/2 gerillt + 1/2 glatt, mit offenem Unterbau, platte cm.56x51 (inbegriffen 1 Abschluss-Element mod.TPA-7)

FR Plaque électriques 1/2 nervurée + 1/2 lisse, sur armoire ouvert, plaque cm.56x51 (inclus 1 Elément de jonction top mod.TPA-7)

ES **FRY-TOP ELÉCTRICO 1/2 ESTRIADO + 1/2 LISO, SOBRE MUEBLE ABIERTO, PLANCHA CM.56X51 (INCLUIDA 1 CHAPA DE CIERRE PARA TOP MOD.TPA-7)**

cm. 60 x 70,5 x 90h

cm. 63 x 77 x 111h / kg 78 / m³ 0,538

7,4 kW
400V~3N
50/60 Hz

€ 2.978,00**FTLR-76ETS**

08060635

FRY-TOP ELETTRICO 1/2 RIGATO + 1/2 LISCIO CROMATO SUPERCHROME (MOCA APPROVED), SU MOBILE A GIORNO, PIASTRA CM.56X51 (INCLUSA 1 TESTATA CHIUSURA PIANO MOD.TPA-7)

EN Electric Fry-top 1/2 grooved + 1/2 smooth chromed griddle SUPERCHROME (Moca Approved), on open cabinet, plate cm.56x51 (included 1 Head end filler strip mod.TPA-7)

DE Griddleplatte elektrische 1/2 gerillt + 1/2 glatt hartverchromt SUPERCHROME (Moca Approved), mit offenem Unterbau, platte cm.56x51 (inbegriffen 1 Abschluss-Element mod.TPA-7)

FR Plaque électriques 1/2 nervurée + 1/2 lisse chromée SUPERCHROME (Moca Approved), sur armoire ouvert, plaque cm.56x51 (inclus 1 Elément de jonction top mod.TPA-7)

ES **FRY-TOP ELÉCTRICO 1/2 ESTRIADO + 1/2 LISO CROMADO SUPERCHROME (MOCA APPROVED), SOBRE MUEBLE ABIERTO, PLANCHA CM.56X51 (INCLUIDA 1 CHAPA DE CIERRE PARA TOP MOD.TPA-7)**

cm. 60 x 70,5 x 90h

cm. 63 x 77 x 111h / kg 78 / m³ 0,538

7,4 kW
400V~3N
50/60 Hz

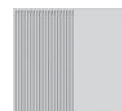
€ 3.514,00

FTR-76ET
 08060633

FRY-TOP ELETTRICO RIGATO, SU MOBILE A GIORNO, PIASTRA CM.56X51 (INCLUSA 1 TESTATA CHIUSURA PIANO MOD.TPA-7)

EN Electric Fry-top grooved griddle, on open cabinet, plate cm.56x51 (included 1 Head end filler strip mod.TPA-7)

DE Griddleplatte elektrische gerillt, mit offenem Unterbau, platte cm.56x51 (inbegriffen 1 Abschluss-Element mod.TPA-7)

FR Plaque électriques nervurée, sur armoire ouvert, plaque cm.56x51 (inclus 1 Élément de jonction top mod.TPA-7)

ES **FRY-TOP ELÉCTRICO ESTRIADO, SOBRE MUEBLE ABIERTO, PLANCHA CM.56X51 (INCLUIDA 1 CHAPA DE CIERRE PARA TOP MOD.TPA-7)**

cm. 60 x 70,5 x 90h

cm. 63 x 77 x 111h / kg 78 / m³ 0,538

⚡ 7,4 kW
 400V~3N
 50/60 Hz

€ 3.075,00

FTR-76ETS
 08060636

FRY-TOP ELETTRICO RIGATO CROMATO SUPERCHROME (MOCA APPROVED), SU MOBILE A GIORNO, PIASTRA CM.56X51 (INCLUSA 1 TESTATA CHIUSURA PIANO MOD.TPA-7)

EN Electric Fry-top grooved chromed griddle SUPERCHROME (Moca Approved), on open cabinet, plate cm.56x51 (included 1 Head end filler strip mod.TPA-7)

DE Griddleplatte elektrische gerillt hartverchromt SUPERCHROME (Moca Approved), mit offenem Unterbau, platte cm.56x51 (inbegriffen 1 Abschluss-Element mod.TPA-7)

FR Plaque électriques nervurée chromée SUPERCHROME (Moca Approved), sur armoire ouvert, plaque cm.56x51 (inclus 1 Élément de jonction top mod.TPA-7)

ES **FRY-TOP ELÉCTRICO ESTRIADO CROMADO SUPERCHROME (MOCA APPROVED), SOBRE MUEBLE ABIERTO, PLANCHA CM.56X51 (INCLUIDA 1 CHAPA DE CIERRE PARA TOP MOD.TPA-7)**

cm. 60 x 70,5 x 90h

cm. 63 x 77 x 111h / kg 78 / m³ 0,538

⚡ 7,4 kW
 400V~3N
 50/60 Hz

€ 3.668,00

FTL-78ET
 08060831

FRY-TOP ELETTRICO LISCIO, SU MOBILE A GIORNO, PIASTRA CM.76X51 - 2 ZONE DI COTTURA (INCLUSA 1 TESTATA CHIUSURA PIANO MOD.TPA-7)

EN Electric Fry-top smooth griddle, on open cabinet, plate cm.76x51 - 2 cooking areas (included 1 Head end filler strip mod.TPA-7)

DE Griddleplatte elektrische glatt, mit offenem Unterbau, platte cm.76x51 - 2 Heizzonen (inbegriffen 1 Abschluss-Element mod.TPA-7)

FR Plaque électriques lisse, sur armoire ouvert, plaque cm.76x51 - 2 zones de cuisson (inclus 1 Élément de jonction top mod.TPA-7)

ES **FRY-TOP ELÉCTRICO LISO, SOBRE MUEBLE ABIERTO, PLANCHA CM.76X51 - 2 ZONAS DE COCCIÓN (INCLUIDA 1 CHAPA DE CIERRE PARA TOP MOD.TPA-7)**

cm. 80 x 70,5 x 90h

cm. 83 x 77 x 111h / kg 110 / m³ 0,709

⚡ 11,1 kW
 400V~3N
 230V~3
 50/60 Hz

€ 3.572,00

FTL-78ETS
 08060834

FRY-TOP ELETTRICO LISCIO CROMATO SUPERCHROME (MOCA APPROVED), SU MOBILE A GIORNO, PIASTRA CM.76X51 - 2 ZONE DI COTTURA (INCLUSA 1 TESTATA CHIUSURA PIANO MOD.TPA-7)

EN Electric Fry-top smooth chromed griddle SUPERCHROME (Moca Approved), on open cabinet, plate cm.76x51 - 2 cooking areas (included 1 Head end filler strip mod.TPA-7)

DE Griddleplatte elektrische glatt hartverchromt SUPERCHROME (Moca Approved), mit offenem Unterbau, platte cm.76x51 - 2 Heizzonen (inbegriffen 1 Abschluss-Element mod.TPA-7)

FR Plaque électriques lisse chromée SUPERCHROME (Moca Approved), sur armoire ouvert, plaque cm.76x51 - 2 zones de cuisson (inclus 1 Élément de jonction top mod.TPA-7)

ES **FRY-TOP ELÉCTRICO LISO CROMADO SUPERCHROME (MOCA APPROVED), SOBRE MUEBLE ABIERTO, PLANCHA CM.76X51 - 2 ZONAS DE COCCIÓN (INCLUIDA 1 CHAPA DE CIERRE PARA TOP MOD.TPA-7)**

cm. 80 x 70,5 x 90h

cm. 83 x 77 x 111h / kg 110 / m³ 0,709

⚡ 11,1 kW
 400V~3N
 230V~3
 50/60 Hz

€ 4.250,00

FTL-78ETSS
 08060830

FRY-TOP ELETTRICO LISCIO CROMO LUCIDO, SU MOBILE A GIORNO, PIASTRA CM.76X51 - 2 ZONE DI COTTURA (INCLUSA 1 TESTATA CHIUSURA PIANO MOD.TPA-7)

EN Electric Fry-top smooth POLISHED CHROME, on open cabinet, plate cm.76x51 - 2 cooking areas (included 1 Head end filler strip mod.TPA-7)

DE Griddleplatte elektrische glatt POLIERTEM CHROM, mit offenem Unterbau, platte cm.76x51 - 2 Heizzonen (inbegriffen 1 Abschluss-Element mod.TPA-7)

FR Plaque électriques lisse CHROME POLI, sur armoire ouvert, plaque cm.76x51 - 2 zones de cuisson (inclus 1 Élément de jonction top mod.TPA-7)

ES **FRY-TOP ELÉCTRICO LISO CROMO PULIDO, SOBRE MUEBLE ABIERTO, PLANCHA CM.76X51 - 2 ZONAS DE COCCIÓN (INCLUIDA 1 CHAPA DE CIERRE PARA TOP MOD.TPA-7)**

cm. 80 x 70,5 x 90h

cm. 83 x 77 x 111h / kg 110 / m³ 0,709

⚡ 11,1 kW
 400V~3N
 230V~3
 50/60 Hz

€ 4.250,00

FTLR-78ET

08060832



FRY-TOP ELETTRICO 1/2 RIGATO + 1/2 LISCIO, SU MOBILE A GIORNO, PIASTRA CM.76X51 - 2 ZONE DI COTTURA (INCLUSA 1 TESTATA CHIUSURA PIANO MOD.TPA-7)

EN Electric Fry-top 1/2 grooved + 1/2 smooth, on open cabinet, plate cm.76x51 - 2 cooking areas (included 1 Head end filler strip mod.TPA-7)

DE Griddleplatte elektrische 1/2 gerillt + 1/2 glatt, mit offenem Unterbau, platte cm.76x51 - 2 Heizzonen (inbegriffen 1 Abschluss-Element mod.TPA-7)

FR Plaque électriques 1/2 nervurée + 1/2 lisse, sur armoire ouvert, plaque cm.76x51 - 2 zones de cuisson (inclus 1 Élément de jonction top mod.TPA-7)

ES **FRY-TOP ELÉCTRICO 1/2 ESTRIADO + 1/2 LISO, SOBRE MUEBLE ABIERTO, PLANCHA CM.76X51 - 2 ZONAS DE COCCIÓN (INCLUIDA 1 CHAPA DE CIERRE PARA TOP MOD.TPA-7)**

cm. 80 x 70,5 x 90h

cm. 83 x 77 x 111h / kg 110 / m³ 0,709

⚡ 11,1 kW
400V~3N
230V~3
50/60 Hz

€ 3.781,00**FTLR-78ETS**

08060835

FRY-TOP ELETTRICO 1/2 RIGATO + 1/2 LISCIO CROMATO SUPERCHROME (MOCA APPROVED), SU MOBILE A GIORNO, PIASTRA CM.76X51 - 2 ZONE DI COTTURA (INCLUSA 1 TESTATA CHIUSURA PIANO MOD.TPA-7)

EN Electric Fry-top 1/2 grooved + 1/2 smooth chromed griddle SUPERCHROME (Moca Approved), on open cabinet, plate cm.76x51 - 2 cooking areas (included 1 Head end filler strip mod.TPA-7)

DE Griddleplatte elektrische 1/2 gerillt + 1/2 glatt hartverchromt SUPERCHROME (Moca Approved), mit offenem Unterbau, platte cm.76x51 - 2 Heizzonen (inbegriffen 1 Abschluss-Element mod.TPA-7)

FR Plaque électriques 1/2 nervurée + 1/2 lisse chromée SUPERCHROME (Moca Approved), sur armoire ouvert, plaque cm.76x51 - 2 zones de cuisson (inclus 1 Élément de jonction top mod.TPA-7)

ES **FRY-TOP ELÉCTRICO 1/2 ESTRIADO + 1/2 LISO CROMADO SUPERCHROME (MOCA APPROVED), SOBRE MUEBLE ABIERTO, PLANCHA CM.76X51 - 2 ZONAS DE COCCIÓN (INCLUIDA 1 CHAPA DE CIERRE PARA TOP MOD.TPA-7)**

cm. 80 x 70,5 x 90h

cm. 83 x 77 x 111h / kg 110 / m³ 0,709

⚡ 11,1 kW
400V~3N
230V~3
50/60 Hz

€ 4.425,00**FTR-78ET**

08060833



FRY-TOP ELETTRICO RIGATO, SU MOBILE A GIORNO, PIASTRA CM.76X51 - 2 ZONE DI COTTURA (INCLUSA 1 TESTATA CHIUSURA PIANO MOD.TPA-7)

EN Electric Fry-top grooved griddle, on open cabinet, plate cm.76x51 - 2 cooking areas (included 1 Head end filler strip mod.TPA-7)

DE Griddleplatte elektrische gerillt, mit offenem Unterbau, platte cm.76x51 - 2 Heizzonen (inbegriffen 1 Abschluss-Element mod.TPA-7)

FR Plaque électriques nervurée, sur armoire ouvert, plaque cm.76x51 - 2 zones de cuisson (inclus 1 Élément de jonction top mod.TPA-7)

ES **FRY-TOP ELÉCTRICO ESTRIADO, SOBRE MUEBLE ABIERTO, PLANCHA CM.76X51 - 2 ZONAS DE COCCIÓN (INCLUIDA 1 CHAPA DE CIERRE PARA TOP MOD.TPA-7)**

cm. 80 x 70,5 x 90h

cm. 83 x 77 x 111h / kg 110 / m³ 0,709

⚡ 11,1 kW
400V~3N
230V~3
50/60 Hz

€ 3.871,00**FTR-78ETS**

08060836

FRY-TOP ELETTRICO RIGATO CROMATO SUPERCHROME (MOCA APPROVED), SU MOBILE A GIORNO, PIASTRA CM.76X51 - 2 ZONE DI COTTURA (INCLUSA 1 TESTATA CHIUSURA PIANO MOD.TPA-7)

EN Electric Fry-top grooved chromed griddle SUPERCHROME (Moca Approved), on open cabinet, plate cm.76x51 - 2 cooking areas (included 1 Head end filler strip mod.TPA-7)

DE Griddleplatte elektrische gerillt hartverchromt SUPERCHROME (Moca Approved), mit offenem Unterbau, platte cm.76x51 - 2 Heizzonen (inbegriffen 1 Abschluss-Element mod.TPA-7)

FR Plaque électriques nervurée chromée SUPERCHROME (Moca Approved), sur armoire ouvert, plaque cm.76x51 - 2 zones de cuisson (inclus 1 Élément de jonction top mod.TPA-7)

ES **FRY-TOP ELÉCTRICO ESTRIADO CROMADO SUPERCHROME (MOCA APPROVED), SOBRE MUEBLE ABIERTO, PLANCHA CM.76X51 - 2 ZONAS DE COCCIÓN (INCLUIDA 1 CHAPA DE CIERRE PARA TOP MOD.TPA-7)**

cm. 80 x 70,5 x 90h

cm. 83 x 77 x 111h / kg 110 / m³ 0,709

⚡ 11,1 kW
400V~3N
230V~3
50/60 Hz

€ 4.612,00

FTL-712ET
 08061231

FRY-TOP ELETTRICO LISCIO, SU MOBILE A GIORNO, PIASTRA CM.116X51 - 2 ZONE DI COTTURA (INCLUSA 1 TESTATA CHIUSURA PIANO MOD.TPA-7)

EN Electric Fry-top smooth griddle, on open cabinet, plate cm.116x51 - 2 cooking areas (included 1 Head end filler strip mod.TPA-7)

DE Griddleplatte elektrische glatt, mit offenem Unterbau, platte cm.116x51 - 2 Heizzonen (inbegriffen 1 Abschluss-Element mod.TPA-7)

FR Plaque électriques lisse, sur armoire ouvert, plaque cm.116x51 - 2 zones de cuisson (inclus 1 Élément de jonction top mod.TPA-7)

ES **FRY-TOP ELÉCTRICO LISO, SOBRE MUEBLE ABIERTO, PLANCHA CM.116X51 - 2 ZONAS DE COCCIÓN (INCLUIDA 1 CHAPA DE CIERRE PARA TOP MOD.TPA-7)**

cm. 120 x 70,5 x 90h

cm. 123 x 77 x 111h / kg 150 / m³ 1,051

14,8 kW **€ 4.540,00**
 400V~3N
 50/60 Hz

FTL-712ETS
 08061234

FRY-TOP ELETTRICO LISCIO CROMATO SUPERCHROME (MOCA APPROVED), SU MOBILE A GIORNO, PIASTRA CM.116X51 - 2 ZONE DI COTTURA (INCLUSA 1 TESTATA CHIUSURA PIANO MOD.TPA-7)

EN Electric Fry-top smooth chromed griddle SUPERCHROME (Moca Approved), on open cabinet, plate cm.116x51 - 2 cooking areas (included 1 Head end filler strip mod.TPA-7)

DE Griddleplatte elektrische glatt hartverchromt SUPERCHROME (Moca Approved), mit offenem Unterbau, platte cm.116x51 - 2 Heizzonen (inbegriffen 1 Abschluss-Element mod.TPA-7)

FR Plaque électriques lisse chromée SUPERCHROME (Moca Approved), sur armoire ouvert, plaque cm.116x51 - 2 zones de cuisson (inclus 1 Élément de jonction top mod.TPA-7)

ES **FRY-TOP ELÉCTRICO LISO CROMADO SUPERCHROME (MOCA APPROVED), SOBRE MUEBLE ABIERTO, PLANCHA CM.116X51 - 2 ZONAS DE COCCIÓN (INCLUIDA 1 CHAPA DE CIERRE PARA TOP MOD.TPA-7)**

cm. 120 x 70,5 x 90h

cm. 123 x 77 x 111h / kg 150 / m³ 1,051

14,8 kW **€ 5.583,00**
 400V~3N
 50/60 Hz

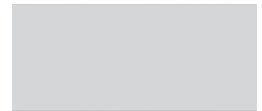
FTLR-712ET
 08061232

FRY-TOP ELETTRICO 1/2 RIGATO + 1/2 LISCIO, SU MOBILE A GIORNO, PIASTRA CM.116X51 - 2 ZONE DI COTTURA (INCLUSA 1 TESTATA CHIUSURA PIANO MOD.TPA-7)

EN Electric Fry-top 1/2 grooved + 1/2 smooth, on open cabinet, plate cm.116x51 - 2 cooking areas (included 1 Head end filler strip mod.TPA-7)

DE Griddleplatte elektrische 1/2 gerillt + 1/2 glatt, mit offenem Unterbau, platte cm.116x51 - 2 Heizzonen (inbegriffen 1 Abschluss-Element mod.TPA-7)

FR Plaque électriques 1/2 nervurée + 1/2 lisse, sur armoire ouvert, plaque cm.116x51 - 2 zones de cuisson (inclus 1 Élément de jonction top mod.TPA-7)

ES **FRY-TOP ELÉCTRICO 1/2 ESTRIADO + 1/2 LISO, SOBRE MUEBLE ABIERTO, PLANCHA CM.116X51 - 2 ZONAS DE COCCIÓN (INCLUIDA 1 CHAPA DE CIERRE PARA TOP MOD.TPA-7)**

cm. 120 x 70,5 x 90h

cm. 123 x 77 x 111h / kg 150 / m³ 1,051

14,8 kW **€ 4.751,00**
 400V~3N
 50/60 Hz

FTLR-712ETS
 08061235

FRY-TOP ELETTRICO 1/2 RIGATO + 1/2 LISCIO CROMATO SUPERCHROME (MOCA APPROVED), SU MOBILE A GIORNO, PIASTRA CM.116X51 - 2 ZONE DI COTTURA (INCLUSA 1 TESTATA CHIUSURA PIANO MOD.TPA-7)

EN Electric Fry-top 1/2 grooved + 1/2 smooth chromed griddle SUPERCHROME (Moca Approved), on open cabinet, plate cm.116x51 - 2 cooking areas (included 1 Head end filler strip mod.TPA-7)

DE Griddleplatte elektrische 1/2 gerillt + 1/2 glatt hartverchromt SUPERCHROME (Moca Approved), mit offenem Unterbau, platte cm.116x51 - 2 Heizzonen (inbegriffen 1 Abschluss-Element mod.TPA-7)

FR Plaque électriques 1/2 nervurée + 1/2 lisse chromée SUPERCHROME (Moca Approved), sur armoire ouvert, plaque cm.116x51 - 2 zones de cuisson (inclus 1 Élément de jonction top mod.TPA-7)

ES **FRY-TOP ELÉCTRICO 1/2 ESTRIADO + 1/2 LISO CROMADO SUPERCHROME (MOCA APPROVED), SOBRE MUEBLE ABIERTO, PLANCHA CM.116X51 - 2 ZONAS DE COCCIÓN (INCLUIDA 1 CHAPA DE CIERRE PARA TOP MOD.TPA-7)**

cm. 120 x 70,5 x 90h

cm. 123 x 77 x 111h / kg 150 / m³ 1,051

14,8 kW **€ 5.901,00**
 400V~3N
 50/60 Hz



FTR-712ET

08061233



FRY-TOP ELETTRICO RIGATO, SU MOBILE A GIORNO, PIASTRA CM.116X51 - 2 ZONE DI COTTURA (INCLUSA 1 TESTATA CHIUSURA PIANO MOD.TPA-7)

- EN** Electric Fry-top grooved griddle, on open cabinet, plate cm.116x51 - 2 cooking areas (included 1 Head end filler strip mod.TPA-7)
- DE** Griddleplatte elektrische gerillt, mit offenem Unterbau, platte cm.116x51 - 2 Heizzonen (inbegriffen 1 Abschluss-Element mod.TPA-7)
- FR** Plaque électriques nervurée, sur armoire ouvert, plaque cm.116x51 - 2 zones de cuisson (inclus 1 Élément de jonction top mod.TPA-7)

ES **FRY-TOP ELÉCTRICO ESTRIADO, SOBRE MUEBLE ABIERTO, PLANCHA CM.116X51 - 2 ZONAS DE COCCIÓN (INCLUIDA 1 CHAPA DE CIERRE PARA TOP MOD.TPA-7)**

cm. 120 x 70,5 x 90h

cm. 123 x 77 x 111h / kg 150 / m³ 1,051

14,8 kW **€ 4.972,00**

400V~3N
50/60 Hz

**FTR-712ETS**

08061236

FRY-TOP ELETTRICO RIGATO CROMATO SUPERCHROME (MOCA APPROVED), SU MOBILE A GIORNO, PIASTRA CM.116X51 - 2 ZONE DI COTTURA (INCLUSA 1 TESTATA CHIUSURA PIANO MOD.TPA-7)

- EN** Electric Fry-top grooved chromed griddle SUPERCHROME (Moca Approved), on open cabinet, plate cm.116x51 - 2 cooking areas (included 1 Head end filler strip mod.TPA-7)
- DE** Griddleplatte elektrische gerillt hartverchromt SUPERCHROME (Moca Approved), mit offenem Unterbau, platte cm.116x51 - 2 Heizzonen (inbegriffen 1 Abschluss-Element mod.TPA-7)
- FR** Plaque électriques nervurée chromée SUPERCHROME (Moca Approved), sur armoire ouvert, plaque cm.116x51 - 2 zones de cuisson (inclus 1 Élément de jonction top mod.TPA-7)

ES **FRY-TOP ELÉCTRICO ESTRIADO CROMADO SUPERCHROME (MOCA APPROVED), SOBRE MUEBLE ABIERTO, PLANCHA CM.116X51 - 2 ZONAS DE COCCIÓN (INCLUIDA 1 CHAPA DE CIERRE PARA TOP MOD.TPA-7)**

cm. 120 x 70,5 x 90h

cm. 123 x 77 x 111h / kg 150 / m³ 1,051

14,8 kW **€ 6.313,00**

400V~3N
50/60 Hz

**FTL-712ET3**

0806123B



FRY-TOP ELETTRICO LISCIO, SU MOBILE A GIORNO, PIASTRA CM.116X51 - 3 ZONE DI COTTURA (INCLUSA 1 TESTATA CHIUSURA PIANO MOD.TPA-7)

- EN** Electric Fry-top smooth griddle, on open cabinet, plate cm.116x51 - 3 cooking areas (included 1 Head end filler strip mod.TPA-7)
- DE** Griddleplatte elektrische glatt, mit offenem Unterbau, platte cm.116x51 - 3 Heizzonen (inbegriffen 1 Abschluss-Element mod.TPA-7)
- FR** Plaque électriques lisse, sur armoire ouvert, plaque cm.116x51 - 3 zones de cuisson (inclus 1 Élément de jonction top mod.TPA-7)

ES **FRY-TOP ELÉCTRICO LISO, SOBRE MUEBLE ABIERTO, PLANCHA CM.116X51 - 3 ZONAS DE COCCIÓN (INCLUIDA 1 CHAPA DE CIERRE PARA TOP MOD.TPA-7)**

cm. 120 x 70,5 x 90h

cm. 123 x 77 x 111h / kg 150 / m³ 1,051

16,65 kW **€ 4.972,00**

400V~3N
50/60 Hz

**FTL-712ETS3**

0806123E

FRY-TOP ELETTRICO LISCIO CROMATO SUPERCHROME (MOCA APPROVED), SU MOBILE A GIORNO, PIASTRA CM.116X51 - 3 ZONE DI COTTURA (INCLUSA 1 TESTATA CHIUSURA PIANO MOD.TPA-7)

- EN** Electric Fry-top smooth chromed griddle SUPERCHROME (Moca Approved), on open cabinet, plate cm.116x51 - 3 cooking areas (included 1 Head end filler strip mod.TPA-7)
- DE** Griddleplatte elektrische glatt hartverchromt SUPERCHROME (Moca Approved), mit offenem Unterbau, platte cm.116x51 - 3 Heizzonen (inbegriffen 1 Abschluss-Element mod.TPA-7)
- FR** Plaque électriques lisse chromée SUPERCHROME (Moca Approved), sur armoire ouvert, plaque cm.116x51 - 3 zones de cuisson (inclus 1 Élément de jonction top mod.TPA-7)

ES **FRY-TOP ELÉCTRICO LISO CROMADO SUPERCHROME (MOCA APPROVED), SOBRE MUEBLE ABIERTO, PLANCHA CM.116X51 - 3 ZONAS DE COCCIÓN (INCLUIDA 1 CHAPA DE CIERRE PARA TOP MOD.TPA-7)**

cm. 120 x 70,5 x 90h

cm. 123 x 77 x 111h / kg 150 / m³ 1,051

16,65 kW **€ 5.965,00**

400V~3N
50/60 Hz

**FTL-712ETSS3**

0806123Y

FRY-TOP ELETTRICO LISCIO CROMO LUCIDO, SU MOBILE A GIORNO, PIASTRA CM.116X51 - 3 ZONE DI COTTURA (INCLUSA 1 TESTATA CHIUSURA PIANO MOD.TPA-7)

- EN** Electric Fry-top smooth POLISHED CHROME, on open cabinet, plate cm.116x51 - 3 cooking areas (included 1 Head end filler strip mod.TPA-7)
- DE** Griddleplatte elektrische glatt POLIERTEM CHROM, mit offenem Unterbau, platte cm.116x51 - 3 Heizzonen (inbegriffen 1 Abschluss-Element mod.TPA-7)
- FR** Plaque électriques lisse CHROME POLI, sur armoire ouvert, plaque cm.116x51 - 3 zones de cuisson (inclus 1 Élément de jonction top mod.TPA-7)

ES **FRY-TOP ELÉCTRICO LISO CROMO PULIDO, SOBRE MUEBLE ABIERTO, PLANCHA CM.116X51 - 3 ZONAS DE COCCIÓN (INCLUIDA 1 CHAPA DE CIERRE PARA TOP MOD.TPA-7)**

cm. 120 x 70,5 x 90h

cm. 123 x 77 x 111h / kg 150 / m³ 1,051

16,65 kW **€ 5.965,00**

400V~3N
50/60 Hz



FTLR-712ET3

0806123C



FRY-TOP ELETTRICO 1/3 RIGATO + 2/3 LISCIO, SU MOBILE A GIORNO, PIASTRA CM.116X51 - 3 ZONE DI COTTURA (INCLUSA 1 TESTATA CHIUSURA PIANO MOD.TPA-7)

EN Electric Fry-top 1/3 grooved + 2/3 smooth, on open cabinet, plate cm.116x51 - 3 cooking areas (included 1 Head end filler strip mod.TPA-7)

DE Griddleplatte elektrische 1/3 gerillt + 2/3 glatt, mit offenem Unterbau, platte cm.116x51 - 3 Heizzonen (inbegriffen 1 Abschluss-Element mod.TPA-7)

FR Plaque électriques 1/3 nervurée + 2/3 lisse, sur armoire ouvert, plaque cm.116x51 - 3 zones de cuisson (inclus 1 Élément de jonction top mod.TPA-7)

ES **FRY-TOP ELÉCTRICO 1/3 ESTRIADO + 2/3 LISO, SOBRE MUEBLE ABIERTO, PLANCHA CM.116X51 - 3 ZONAS DE COCCIÓN (INCLUIDA 1 CHAPA DE CIERRE PARA TOP MOD.TPA-7)**

cm. 120 x 70,5 x 90h

cm. 123 x 77 x 111h / kg 150 / m³ 1,051

16,65 KW

400V~3N
50/60 Hz

€ 5.105,00

FTLR-712ETS3

0806123F

FRY-TOP ELETTRICO 1/3 RIGATO + 2/3 LISCIO CROMATO SUPERCHROME (MOCA APPROVED), SU MOBILE A GIORNO, PIASTRA CM.116X51 - 3 ZONE DI COTTURA (INCLUSA 1 TESTATA CHIUSURA PIANO MOD.TPA-7)

EN Electric Fry-top 1/3 grooved + 2/3 smooth chromed griddle SUPERCHROME (Moca Approved), on open cabinet, plate cm.116x51 - 3 cooking areas (included 1 Head end filler strip mod.TPA-7)

DE Griddleplatte elektrische 1/3 gerillt + 2/3 glatt hartverchromt SUPERCHROME (Moca Approved), mit offenem Unterbau, platte cm.116x51 - 3 Heizzonen (inbegriffen 1 Abschluss-Element mod.TPA-7)

FR Plaque électriques 1/3 nervurée + 2/3 lisse chromée SUPERCHROME (Moca Approved), sur armoire ouvert, plaque cm.116x51 - 3 zones de cuisson (inclus 1 Élément de jonction top mod.TPA-7)

ES **FRY-TOP ELÉCTRICO 1/3 ESTRIADO + 2/3 LISO CROMADO SUPERCHROME (MOCA APPROVED), SOBRE MUEBLE ABIERTO, PLANCHA CM.116X51 - 3 ZONAS DE COCCIÓN (INCLUIDA 1 CHAPA DE CIERRE PARA TOP MOD.TPA-7)**

cm. 120 x 70,5 x 90h

cm. 123 x 77 x 111h / kg 150 / m³ 1,051

16,65 kW

400V~3N
50/60 Hz

€ 6.106,00

PIASTRA PER SANDWICH SOPRA FRYTOP

EN SANDWICHES PLATE ABOVE GRIDLDE **DE** SANDWICHES PLATTE ÜBER GRIDDLE **FR** PLAQUE POUR SANDWICHES AU-DESSUS FRY-TOP
ES **PLANCIA PARA SÁNDWICHES SOBRE FRY-TOP**

RSFT-73EM

18630317



PIASTRA PER SANDWICH SOPRA FRYTOP ELETTRICI - PIASTRA CM. 29X40 (ATTENZIONE: PROFONDITA' MACCHINA +CM.10)

EN Sandwiches plate above electric gridlde - plate cm. 29x40 (ATTENTION: DEPTH MACHINE +cm.10)

DE Sandwiches Platte über Elektrische Griddle - platte cm. 29x40 (VORSICHT: TIEFE MACHINE +cm.10)

FR Plaque pour sandwichs au-dessus électrique fry-top - plaque cm. 29x40 (ATTENTION: PROFONDEUR MACHINE +cm.10)

ES **PLANCIA PARA SÁNDWICHES SOBRE FRY-TOP ELÉCTRICO - PLANCIA CM. 29X40 (ATENCIÓN: PROFUNDIDAD MÁQUINA +CM.10)**

cm. 32 x 62 x 41h

cm. 43 x 77 x 63h / kg 20 / m³ 0,209

2,9 KW

230V~
50/60 Hz

€ 1.552,00

FRY-TOP A GAS

EN GAS GRIDDLE DE GASGRIDDLEPLATTEN FR FRY-TOP À GAZ ES FRY-TOP A GAS

FTL-74G

08230451



FRY-TOP GAS LISCIO, SU MOBILE A GIORNO, PIASTRA CM.36X51 (INCLUSA 1 TESTATA CHIUSURA PIANO MOD.TPA-7)

EN Gas Fry-top smooth griddle, on open cabinet, plate cm.36x51 (included 1 Head end filler strip mod.TPA-7)

DE Gas-griddleplatte glatt, mit offenem Unterbau, platte cm.36x51 (inbegriffen 1 Abschluss-Element mod.TPA-7)

FR Plaque gaz lisse, sur armoire ouvert, plaque cm.36x51 (inclus 1 Élément de jonction top mod.TPA-7)

ES **FRY-TOP GAS LISO, SOBRE MUEBLE ABIERTO, PLANCHA CM.36X51 (INCLUIDA 1 CHAPA DE CIERRE PARA TOP MOD.TPA-7)**

cm. 40 x 70,5 x 90h

cm. 43 x 77 x 111h / kg 69 / m³ 0,368

7 kW
6.020 kcal/h

€ 2.508,00



FTL-74GS

08230454

FRY-TOP GAS LISCIO CROMATO SUPERCHROME (MOCA APPROVED), SU MOBILE A GIORNO, PIASTRA CM.36X51 (INCLUSA 1 TESTATA CHIUSURA PIANO MOD.TPA-7)

EN Gas Fry-top smooth chromed griddle SUPERCHROME (Moca Approved), on open cabinet, plate cm.36x51 (included 1 Head end filler strip mod.TPA-7)

DE Gas-griddleplatte glatt hartverchromt SUPERCHROME (Moca Approved), mit offenem Unterbau, platte cm.36x51 (inbegriffen 1 Abschluss-Element mod.TPA-7)

FR Plaque gaz lisse chromée SUPERCHROME (Moca Approved), sur armoire ouvert, plaque cm.36x51 (inclus 1 Élément de jonction top mod.TPA-7)

ES **FRY-TOP GAS LISO CROMADO SUPERCHROME (MOCA APPROVED), SOBRE MUEBLE ABIERTO, PLANCHA CM.36X51 (INCLUIDA 1 CHAPA DE CIERRE PARA TOP MOD.TPA-7)**

cm. 40 x 70,5 x 90h

cm. 43 x 77 x 111h / kg 69 / m³ 0,368

7 kW
6.020 kcal/h

€ 2.969,00



FTL-74GSS

08230450

FRY-TOP GAS LISCIO CROMO LUCIDO, SU MOBILE A GIORNO, PIASTRA CM.36X51 (INCLUSA 1 TESTATA CHIUSURA PIANO MOD.TPA-7)

EN Gas Fry-top smooth POLISHED CHROME, on open cabinet, plate cm.36x51 (included 1 Head end filler strip mod.TPA-7)

DE Gas-griddleplatte glatt POLIERTEM CHROM, mit offenem Unterbau, platte cm.36x51 (inbegriffen 1 Abschluss-Element mod.TPA-7)

FR Plaque gaz lisse CHROME POLI, sur armoire ouvert, plaque cm.36x51 (inclus 1 Élément de jonction top mod.TPA-7)

ES **FRY-TOP GAS LISO CROMO PULIDO, SOBRE MUEBLE ABIERTO, PLANCHA CM.36X51 (INCLUIDA 1 CHAPA DE CIERRE PARA TOP MOD.TPA-7)**

cm. 40 x 70,5 x 90h

cm. 43 x 77 x 111h / kg 69 / m³ 0,368

7 kW
6.020 kcal/h

€ 2.969,00



FTR-74G

08230453



FRY-TOP GAS RIGATO, SU MOBILE A GIORNO, PIASTRA CM.36X51 (INCLUSA 1 TESTATA CHIUSURA PIANO MOD.TPA-7)

EN Gas Fry-top grooved griddle, on open cabinet, plate cm.36x51 (included 1 Head end filler strip mod.TPA-7)

DE Gas-griddleplatte gerillt, mit offenem Unterbau, platte cm.36x51 (inbegriffen 1 Abschluss-Element mod.TPA-7)

FR Plaque gaz nervurée, sur armoire ouvert, plaque cm.36x51 (inclus 1 Élément de jonction top mod.TPA-7)

ES **FRY-TOP GAS ESTRIADO, SOBRE MUEBLE ABIERTO, PLANCHA CM.36X51 (INCLUIDA 1 CHAPA DE CIERRE PARA TOP MOD.TPA-7)**

cm. 40 x 70,5 x 90h

cm. 43 x 77 x 111h / kg 69 / m³ 0,368

7 kW
6.020 kcal/h

€ 2.687,00



FTR-74GS

08230456

FRY-TOP GAS RIGATO CROMATO SUPERCHROME (MOCA APPROVED), SU MOBILE A GIORNO, PIASTRA CM.36X51 (INCLUSA 1 TESTATA CHIUSURA PIANO MOD.TPA-7)

EN Gas Fry-top grooved chromed griddle SUPERCHROME (Moca Approved), on open cabinet, plate cm.36x51 (included 1 Head end filler strip mod.TPA-7)

DE Gas-griddleplatte gerillt hartverchromt SUPERCHROME (Moca Approved), mit offenem Unterbau, platte cm.36x51 (inbegriffen 1 Abschluss-Element mod.TPA-7)

FR Plaque gaz nervurée chromée SUPERCHROME (Moca Approved), sur armoire ouvert, plaque cm.36x51 (inclus 1 Élément de jonction top mod.TPA-7)

ES **FRY-TOP GAS ESTRIADO CROMADO SUPERCHROME (MOCA APPROVED), SOBRE MUEBLE ABIERTO, PLANCHA CM.36X51 (INCLUIDA 1 CHAPA DE CIERRE PARA TOP MOD.TPA-7)**

cm. 40 x 70,5 x 90h

cm. 43 x 77 x 111h / kg 69 / m³ 0,368

7 kW
6.020 kcal/h

€ 3.142,00



FTL-76G

08230651



FRY-TOP GAS LISCIO, SU MOBILE A GIORNO, PIASTRA CM.56X51 (INCLUSA 1 TESTATA CHIUSURA PIANO MOD.TPA-7)

- EN** Gas Fry-top smooth griddle, on open cabinet, plate cm.56x51 (included 1 Head end filler strip mod.TPA-7)
- DE** Gas-griddleplatte glatt, mit offenem Unterbau, platte cm.56x51 (inbegriffen 1 Abschluss-Element mod.TPA-7)
- FR** Plaque gaz lisse, sur armoire ouvert, plaque cm.56x51 (inclus 1 Elément de jonction top mod.TPA-7)

ES **FRY-TOP GAS LISO, SOBRE MUEBLE ABIERTO, PLANCHA CM.56X51 (INCLUIDA 1 CHAPA DE CIERRE PARA TOP MOD.TPA-7)**

cm. 60 x 70,5 x 90h

cm. 63 x 77 x 111h / kg 83 / m³ 0,538

10,5 kW
9.030 kcal/h

€ 2.934,00

FTL-76GS

08230654

FRY-TOP GAS LISCIO CROMATO SUPERCHROME (MOCA APPROVED), SU MOBILE A GIORNO, PIASTRA CM.56X51 (INCLUSA 1 TESTATA CHIUSURA PIANO MOD.TPA-7)

- EN** Gas Fry-top smooth chromed griddle SUPERCHROME (Moca Approved), on open cabinet, plate cm.56x51 (included 1 Head end filler strip mod.TPA-7)
- DE** Gas-griddleplatte glatt hartverchromt SUPERCHROME (Moca Approved), mit offenem Unterbau, platte cm.56x51 (inbegriffen 1 Abschluss-Element mod.TPA-7)
- FR** Plaque gaz lisse chromée SUPERCHROME (Moca Approved), sur armoire ouvert, plaque cm.56x51 (inclus 1 Elément de jonction top mod.TPA-7)

ES **FRY-TOP GAS LISO CROMADO SUPERCHROME (MOCA APPROVED), SOBRE MUEBLE ABIERTO, PLANCHA CM.56X51 (INCLUIDA 1 CHAPA DE CIERRE PARA TOP MOD.TPA-7)**

cm. 60 x 70,5 x 90h

cm. 63 x 77 x 111h / kg 83 / m³ 0,538

10,5 kW
9.030 kcal/h

€ 3.575,00

FTL-76GSS

08230650

FRY-TOP GAS LISCIO CROMO LUCIDO, SU MOBILE A GIORNO, PIASTRA CM.56X51 (INCLUSA 1 TESTATA CHIUSURA PIANO MOD.TPA-7)

- EN** Gas Fry-top smooth POLISHED CHROME, on open cabinet, plate cm.56x51 (included 1 Head end filler strip mod.TPA-7)
- DE** Gas-griddleplatte glatt POLIERTEM CHROM, mit offenem Unterbau, platte cm.56x51 (inbegriffen 1 Abschluss-Element mod.TPA-7)
- FR** Plaque gaz lisse CHROME POLI, sur armoire ouvert, plaque cm.56x51 (inclus 1 Elément de jonction top mod.TPA-7)

ES **FRY-TOP GAS LISO CROMO PULIDO, SOBRE MUEBLE ABIERTO, PLANCHA CM.56X51 (INCLUIDA 1 CHAPA DE CIERRE PARA TOP MOD.TPA-7)**

cm. 60 x 70,5 x 90h

cm. 63 x 77 x 111h / kg 83 / m³ 0,538

10,5 kW
9.030 kcal/h

€ 3.575,00

FTLR-76G

08230652



FRY-TOP GAS 1/2 RIGATO + 1/2 LISCIO, SU MOBILE A GIORNO, PIASTRA CM.56X51 (INCLUSA 1 TESTATA CHIUSURA PIANO MOD.TPA-7)

- EN** Gas Fry-top 1/2 grooved + 1/2 smooth, on open cabinet, plate cm.56x51 (included 1 Head end filler strip mod.TPA-7)
- DE** Gas-griddleplatte 1/2 gerillt + 1/2 glatt, mit offenem Unterbau, platte cm.56x51 (inbegriffen 1 Abschluss-Element mod.TPA-7)
- FR** Plaque gaz 1/2 nervurée + 1/2 lisse, sur armoire ouvert, plaque cm.56x51 (inclus 1 Elément de jonction top mod.TPA-7)

ES **FRY-TOP GAS 1/2 ESTRIADO + 1/2 LISO, SOBRE MUEBLE ABIERTO, PLANCHA CM.56X51 (INCLUIDA 1 CHAPA DE CIERRE PARA TOP MOD.TPA-7)**

cm. 60 x 70,5 x 90h

cm. 63 x 77 x 111h / kg 83 / m³ 0,538

10,5 kW
9.030 kcal/h

€ 3.078,00

FTLR-76GS

08230655

FRY-TOP GAS 1/2 RIGATO + 1/2 LISCIO CROMATO SUPERCHROME (MOCA APPROVED), SU MOBILE A GIORNO, PIASTRA CM.56X51 (INCLUSA 1 TESTATA CHIUSURA PIANO MOD.TPA-7)

- EN** Gas Fry-top 1/2 grooved + 1/2 smooth chromed griddle SUPERCHROME (Moca Approved), on open cabinet, plate cm.56x51 (included 1 Head end filler strip mod.TPA-7)
- DE** Gas-griddleplatte 1/2 gerillt + 1/2 glatt hartverchromt SUPERCHROME (Moca Approved), mit offenem Unterbau, platte cm.56x51 (inbegriffen 1 Abschluss-Element mod.TPA-7)
- FR** Plaque gaz 1/2 nervurée + 1/2 lisse chromée SUPERCHROME (Moca Approved), sur armoire ouvert, plaque cm.56x51 (inclus 1 Elément de jonction top mod.TPA-7)

ES **FRY-TOP GAS 1/2 ESTRIADO + 1/2 LISO CROMADO SUPERCHROME (MOCA APPROVED), SOBRE MUEBLE ABIERTO, PLANCHA CM.56X51 (INCLUIDA 1 CHAPA DE CIERRE PARA TOP MOD.TPA-7)**

cm. 60 x 70,5 x 90h

cm. 63 x 77 x 111h / kg 83 / m³ 0,538

10,5 kW
9.030 kcal/h

€ 3.724,00

FTR-76G

08230653



FRY-TOP GAS RIGATO, SU MOBILE A GIORNO, PIASTRA CM.56X51 (INCLUSA 1 TESTATA CHIUSURA PIANO MOD.TPA-7)

- EN** Gas Fry-top grooved griddle, on open cabinet, plate cm.56x51 (included 1 Head end filler strip mod.TPA-7)
- DE** Gas-griddleplatte gerillt, mit offenem Unterbau, platte cm.56x51 (inbegriffen 1 Abschluss-Element mod.TPA-7)
- FR** Plaque gaz nervurée, sur armoire ouvert, plaque cm.56x51 (inclus 1 Elément de jonction top mod.TPA-7)

ES FRY-TOP GAS ESTRIADO, SOBRE MUEBLE ABIERTO, PLANCHA CM.56X51 (INCLUIDA 1 CHAPA DE CIERRE PARA TOP MOD.TPA-7)

cm. 60 x 70,5 x 90h

cm. 63 x 77 x 111h / kg 83 / m³ 0,538

10,5 kW
9.030 kcal/h

€ 3.207,00**FTR-76GS**

08230656

FRY-TOP GAS RIGATO CROMATO SUPERCHROME (MOCA APPROVED), SU MOBILE A GIORNO, PIASTRA CM.56X51 (INCLUSA 1 TESTATA CHIUSURA PIANO MOD.TPA-7)

- EN** Gas Fry-top grooved chromed griddle SUPERCHROME (Moca Approved), on open cabinet, plate cm.56x51 (included 1 Head end filler strip mod.TPA-7)
- DE** Gas-griddleplatte gerillt hartverchromt SUPERCHROME (Moca Approved), mit offenem Unterbau, platte cm.56x51 (inbegriffen 1 Abschluss-Element mod.TPA-7)
- FR** Plaque gaz nervurée chromée SUPERCHROME (Moca Approved), sur armoire ouvert, plaque cm.56x51 (inclus 1 Elément de jonction top mod.TPA-7)

ES FRY-TOP GAS ESTRIADO CROMADO SUPERCHROME (MOCA APPROVED), SOBRE MUEBLE ABIERTO, PLANCHA CM.56X51 (INCLUIDA 1 CHAPA DE CIERRE PARA TOP MOD.TPA-7)

cm. 60 x 70,5 x 90h

cm. 63 x 77 x 111h / kg 83 / m³ 0,538

10,5 kW
9.030 kcal/h

€ 3.842,00**FTL-78G**

08230851



FRY-TOP GAS LISCIO, SU MOBILE A GIORNO, PIASTRA CM.76X51 - 2 ZONE DI COTTURA (INCLUSA 1 TESTATA CHIUSURA PIANO MOD.TPA-7)

- EN** Gas Fry-top smooth griddle, on open cabinet, plate cm.76x51 - 2 cooking areas (included 1 Head end filler strip mod.TPA-7)
- DE** Gas-griddleplatte glatt, mit offenem Unterbau, platte cm.76x51 - 2 Heizzonen (inbegriffen 1 Abschluss-Element mod.TPA-7)
- FR** Plaque gaz lisse, sur armoire ouvert, plaque cm.76x51 - 2 zones de cuisson (inclus 1 Elément de jonction top mod.TPA-7)

ES FRY-TOP GAS LISO, SOBRE MUEBLE ABIERTO, PLANCHA CM.76X51 - 2 ZONAS DE COCCIÓN (INCLUIDA 1 CHAPA DE CIERRE PARA TOP MOD.TPA-7)

cm. 80 x 70,5 x 90h

cm. 83 x 77 x 111h / kg 114 / m³ 0,709

14 kW
12.040 kcal/h

€ 4.029,00**FTL-78GS**

08230854

FRY-TOP GAS LISCIO CROMATO SUPERCHROME (MOCA APPROVED), SU MOBILE A GIORNO, PIASTRA CM.76X51 - 2 ZONE DI COTTURA (INCLUSA 1 TESTATA CHIUSURA PIANO MOD.TPA-7)

- EN** Gas Fry-top smooth chromed griddle SUPERCHROME (Moca Approved), on open cabinet, plate cm.76x51 - 2 cooking areas (included 1 Head end filler strip mod.TPA-7)
- DE** Gas-griddleplatte glatt hartverchromt SUPERCHROME (Moca Approved), mit offenem Unterbau, platte cm.76x51 - 2 Heizzonen (inbegriffen 1 Abschluss-Element mod.TPA-7)
- FR** Plaque gaz lisse chromée SUPERCHROME (Moca Approved), sur armoire ouvert, plaque cm.76x51 - 2 zones de cuisson (inclus 1 Elément de jonction top mod.TPA-7)

ES FRY-TOP GAS LISO CROMADO SUPERCHROME (MOCA APPROVED), SOBRE MUEBLE ABIERTO, PLANCHA CM.76X51 - 2 ZONAS DE COCCIÓN (INCLUIDA 1 CHAPA DE CIERRE PARA TOP MOD.TPA-7)

cm. 80 x 70,5 x 90h

cm. 83 x 77 x 111h / kg 114 / m³ 0,709

14 kW
12.040 kcal/h

€ 4.756,00**FTL-78GSS**

08230850

FRY-TOP GAS LISCIO CROMO LUCIDO, SU MOBILE A GIORNO, PIASTRA CM.76X51 - 2 ZONE DI COTTURA (INCLUSA 1 TESTATA CHIUSURA PIANO MOD.TPA-7)

- EN** Gas Fry-top smooth POLISHED CHROME, on open cabinet, plate cm.76x51 - 2 cooking areas (included 1 Head end filler strip mod.TPA-7)
- DE** Gas-griddleplatte glatt POLIERTEM CHROM, mit offenem Unterbau, platte cm.76x51 - 2 Heizzonen (inbegriffen 1 Abschluss-Element mod.TPA-7)
- FR** Plaque gaz lisse CHROME POLI, sur armoire ouvert, plaque cm.76x51 - 2 zones de cuisson (inclus 1 Elément de jonction top mod.TPA-7)

ES FRY-TOP GAS LISO CROMO PULIDO, SOBRE MUEBLE ABIERTO, PLANCHA CM.76X51 - 2 ZONAS DE COCCIÓN (INCLUIDA 1 CHAPA DE CIERRE PARA TOP MOD.TPA-7)

cm. 80 x 70,5 x 90h

cm. 83 x 77 x 111h / kg 114 / m³ 0,709

14 kW
12.040 kcal/h

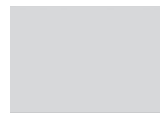
€ 4.756,00

FTLR-78G

08230852



FRY-TOP GAS 1/2 RIGATO + 1/2 LISCIO, SU MOBILE A GIORNO, PIASTRA CM.76X51 - 2 ZONE DI COTTURA (INCLUSA 1 TESTATA CHIUSURA PIANO MOD.TPA-7)

- EN** Gas Fry-top 1/2 grooved + 1/2 smooth, on open cabinet, plate cm.76x51 - 2 cooking areas (included 1 Head end filler strip mod.TPA-7)
- DE** Gas-griddleplatte 1/2 gerillt + 1/2 glatt, mit offenem Unterbau, platte cm.76x51 - 2 Heizzonen (inbegriffen 1 Abschluss-Element mod.TPA-7)
- FR** Plaque gaz 1/2 nervurée + 1/2 lisse, sur armoire ouvert, plaque cm.76x51 - 2 zones de cuisson (inclus 1 Élément de jonction top mod.TPA-7)
- ES** **FRY-TOP GAS 1/2 ESTRIADO + 1/2 LISO, SOBRE MUEBLE ABIERTO, PLANCHA CM.76X51 - 2 ZONAS DE COCCIÓN (INCLUIDA 1 CHAPA DE CIERRE PARA TOP MOD.TPA-7)**

cm. 80 x 70,5 x 90h
 cm. 83 x 77 x 111h / kg 114 / m³ 0,709

€ 4.233,00
 14 kW
 12.040 kcal/h

FTLR-78GS

08230855

FRY-TOP GAS 1/2 RIGATO + 1/2 LISCIO CROMATO SUPERCHROME (MOCA APPROVED), SU MOBILE A GIORNO, PIASTRA CM.76X51 - 2 ZONE DI COTTURA (INCLUSA 1 TESTATA CHIUSURA PIANO MOD.TPA-7)

- EN** Gas Fry-top 1/2 grooved + 1/2 smooth chromed griddle SUPERCHROME (Moca Approved), on open cabinet, plate cm.76x51 - 2 cooking areas (included 1 Head end filler strip mod.TPA-7)
- DE** Gas-griddleplatte 1/2 gerillt + 1/2 glatt hartverchromt SUPERCHROME (Moca Approved), mit offenem Unterbau, platte cm.76x51 - 2 Heizzonen (inbegriffen 1 Abschluss-Element mod.TPA-7)
- FR** Plaque gaz 1/2 nervurée + 1/2 lisse chromée SUPERCHROME (Moca Approved), sur armoire ouvert, plaque cm.76x51 - 2 zones de cuisson (inclus 1 Élément de jonction top mod.TPA-7)
- ES** **FRY-TOP GAS 1/2 ESTRIADO + 1/2 LISO CROMADO SUPERCHROME (MOCA APPROVED), SOBRE MUEBLE ABIERTO, PLANCHA CM.76X51 - 2 ZONAS DE COCCIÓN (INCLUIDA 1 CHAPA DE CIERRE PARA TOP MOD.TPA-7)**

cm. 80 x 70,5 x 90h
 cm. 83 x 77 x 111h / kg 114 / m³ 0,709

€ 4.962,00
 14 kW
 12.040 kcal/h

FTR-78G

08230853



FRY-TOP GAS RIGATO, SU MOBILE A GIORNO, PIASTRA CM.76X51 - 2 ZONE DI COTTURA (INCLUSA 1 TESTATA CHIUSURA PIANO MOD.TPA-7)

- EN** Gas Fry-top grooved griddle, on open cabinet, plate cm.76x51 - 2 cooking areas (included 1 Head end filler strip mod.TPA-7)
- DE** Gas-griddleplatte gerillt, mit offenem Unterbau, platte cm.76x51 - 2 Heizzonen (inbegriffen 1 Abschluss-Element mod.TPA-7)
- FR** Plaque gaz nervurée, sur armoire ouvert, plaque cm.76x51 - 2 zones de cuisson (inclus 1 Élément de jonction top mod.TPA-7)
- ES** **FRY-TOP GAS ESTRIADO, SOBRE MUEBLE ABIERTO, PLANCHA CM.76X51 - 2 ZONAS DE COCCIÓN (INCLUIDA 1 CHAPA DE CIERRE PARA TOP MOD.TPA-7)**

cm. 80 x 70,5 x 90h
 cm. 83 x 77 x 111h / kg 114 / m³ 0,709

€ 4.428,00
 14 kW
 12.040 kcal/h

FTR-78GS

08230856

FRY-TOP GAS RIGATO CROMATO SUPERCHROME (MOCA APPROVED), SU MOBILE A GIORNO, PIASTRA CM.76X51 - 2 ZONE DI COTTURA (INCLUSA 1 TESTATA CHIUSURA PIANO MOD.TPA-7)

- EN** Gas Fry-top grooved chromed griddle SUPERCHROME (Moca Approved), on open cabinet, plate cm.76x51 - 2 cooking areas (included 1 Head end filler strip mod.TPA-7)
- DE** Gas-griddleplatte gerillt hartverchromt SUPERCHROME (Moca Approved), mit offenem Unterbau, platte cm.76x51 - 2 Heizzonen (inbegriffen 1 Abschluss-Element mod.TPA-7)
- FR** Plaque gaz nervurée chromée SUPERCHROME (Moca Approved), sur armoire ouvert, plaque cm.76x51 - 2 zones de cuisson (inclus 1 Élément de jonction top mod.TPA-7)
- ES** **FRY-TOP GAS ESTRIADO CROMADO SUPERCHROME (MOCA APPROVED), SOBRE MUEBLE ABIERTO, PLANCHA CM.76X51 - 2 ZONAS DE COCCIÓN (INCLUIDA 1 CHAPA DE CIERRE PARA TOP MOD.TPA-7)**

cm. 80 x 70,5 x 90h
 cm. 83 x 77 x 111h / kg 114 / m³ 0,709

€ 5.179,00
 14 kW
 12.040 kcal/h



FTL-712G

08231251



FRY-TOP GAS LISCIO, SU MOBILE A GIORNO, PIASTRA CM.116X51 - 2 ZONE DI COTTURA (INCLUSA 1 TESTATA CHIUSURA PIANO MOD.TPA-7)

- EN** Gas Fry-top smooth griddle, on open cabinet, plate cm.116x51 - 2 cooking areas (included 1 Head end filler strip mod.TPA-7)
- DE** Gas-griddleplatte glatt, mit offenem Unterbau, platte cm.116x51 - 2 Heizzonen (inbegriffen 1 Abschluss-Element mod.TPA-7)
- FR** Plaque gaz lisse, sur armoire ouvert, plaque cm.116x51 - 2 zones de cuisson (inclus 1 Elément de jonction top mod.TPA-7)
- ES** **FRY-TOP GAS LISO, SOBRE MUEBLE ABIERTO, PLANCHA CM.116X51 - 2 ZONAS DE COCCIÓN (INCLUIDA 1 CHAPA DE CIERRE PARA TOP MOD. TPA-7)**

cm. 120 x 70,5 x 90h

cm. 123 x 77 x 111h / kg 154 / m³ 1,051

21 kW **€ 5.078,00**
18.060 kcal/h

**FTL-712GS**

08231254

FRY-TOP GAS LISCIO CROMATO SUPERCHROME (MOCA APPROVED), SU MOBILE A GIORNO, PIASTRA CM.116X51 - 2 ZONE DI COTTURA (INCLUSA 1 TESTATA CHIUSURA PIANO MOD.TPA-7)

- EN** Gas Fry-top smooth chromed griddle SUPERCHROME (Moca Approved), on open cabinet, plate cm.116x51 - 2 cooking areas (included 1 Head end filler strip mod.TPA-7)
- DE** Gas-griddleplatte glatt hartverchromt SUPERCHROME (Moca Approved), mit offenem Unterbau, platte cm.116x51 - 2 Heizzonen (inbegriffen 1 Abschluss-Element mod.TPA-7)
- FR** Plaque gaz lisse chromée SUPERCHROME (Moca Approved), sur armoire ouvert, plaque cm.116x51 - 2 zones de cuisson (inclus 1 Elément de jonction top mod.TPA-7)
- ES** **FRY-TOP GAS LISO CROMADO SUPERCHROME (MOCA APPROVED), SOBRE MUEBLE ABIERTO, PLANCHA CM.116X51 - 2 ZONAS DE COCCIÓN (INCLUIDA 1 CHAPA DE CIERRE PARA TOP MOD.TPA-7)**

cm. 120 x 70,5 x 90h

cm. 123 x 77 x 111h / kg 154 / m³ 1,051

21 kW **€ 5.996,00**
18.060 kcal/h

**FTLR-712G**

08231252



FRY-TOP GAS 1/2 RIGATO + 1/2 LISCIO, SU MOBILE A GIORNO, PIASTRA CM.116X51 - 2 ZONE DI COTTURA (INCLUSA 1 TESTATA CHIUSURA PIANO MOD.TPA-7)

- EN** Gas Fry-top 1/2 grooved + 1/2 smooth, on open cabinet, plate cm.116x51 - 2 cooking areas (included 1 Head end filler strip mod.TPA-7)
- DE** Gas-griddleplatte 1/2 gerillt + 1/2 glatt, mit offenem Unterbau, platte cm.116x51 - 2 Heizzonen (inbegriffen 1 Abschluss-Element mod.TPA-7)
- FR** Plaque gaz 1/2 nervurée + 1/2 lisse, sur armoire ouvert, plaque cm.116x51 - 2 zones de cuisson (inclus 1 Elément de jonction top mod.TPA-7)
- ES** **FRY-TOP GAS 1/2 ESTRIADO + 1/2 LISO, SOBRE MUEBLE ABIERTO, PLANCHA CM.116X51 - 2 ZONAS DE COCCIÓN (INCLUIDA 1 CHAPA DE CIERRE PARA TOP MOD.TPA-7)**

cm. 120 x 70,5 x 90h

cm. 123 x 77 x 111h / kg 154 / m³ 1,051

21 kW **€ 5.332,00**
18.060 kcal/h

**FTLR-712GS**

08231255

FRY-TOP GAS 1/2 RIGATO + 1/2 LISCIO CROMATO SUPERCHROME (MOCA APPROVED), SU MOBILE A GIORNO, PIASTRA CM.116X51 - 2 ZONE DI COTTURA (INCLUSA 1 TESTATA CHIUSURA PIANO MOD.TPA-7)

- EN** Gas Fry-top 1/2 grooved + 1/2 smooth chromed griddle SUPERCHROME (Moca Approved), on open cabinet, plate cm.116x51 - 2 cooking areas (included 1 Head end filler strip mod.TPA-7)
- DE** Gas-griddleplatte 1/2 gerillt + 1/2 glatt hartverchromt SUPERCHROME (Moca Approved), mit offenem Unterbau, platte cm.116x51 - 2 Heizzonen (inbegriffen 1 Abschluss-Element mod.TPA-7)
- FR** Plaque gaz 1/2 nervurée + 1/2 lisse chromée SUPERCHROME (Moca Approved), sur armoire ouvert, plaque cm.116x51 - 2 zones de cuisson (inclus 1 Elément de jonction top mod.TPA-7)
- ES** **FRY-TOP GAS 1/2 ESTRIADO + 1/2 LISO CROMADO SUPERCHROME (MOCA APPROVED), SOBRE MUEBLE ABIERTO, PLANCHA CM.116X51 - 2 ZONAS DE COCCIÓN (INCLUIDA 1 CHAPA DE CIERRE PARA TOP MOD. TPA-7)**

cm. 120 x 70,5 x 90h

cm. 123 x 77 x 111h / kg 154 / m³ 1,051

21 kW **€ 6.206,00**
18.060 kcal/h



FTR-712G
 08231253

FRY-TOP GAS RIGATO, SU MOBILE A GIORNO, PIASTRA CM.116X51 - 2 ZONE DI COTTURA (INCLUSA 1 TESTATA CHIUSURA PIANO MOD.TPA-7)

- EN** Gas Fry-top grooved griddle, on open cabinet, plate cm.116x51 - 2 cooking areas (included 1 Head end filler strip mod.TPA-7)
- DE** Gas-griddleplatte gerillt, mit offenem Unterbau, platte cm.116x51 - 2 Heizzonen (inbegriffen 1 Abschluss-Element mod.TPA-7)
- FR** Plaque gaz nervurée, sur armoire ouvert, plaque cm.116x51 - 2 zones de cuisson (inclus 1 Élément de jonction top mod.TPA-7)

ES FRY-TOP GAS ESTRIADO, SOBRE MUEBLE ABIERTO, PLANCHA CM.116X51 - 2 ZONAS DE COCCIÓN (INCLUIDA 1 CHAPA DE CIERRE PARA TOP MOD. TPA-7)

- cm. 120 x 70,5 x 90h
- cm. 123 x 77 x 111h / kg 154 / m³ 1,051

21 kW **€ 5.590,00**
18.060 kcal/h

FTR-712GS
 08231256

FRY-TOP GAS RIGATO CROMATO SUPERCHROME (MOCA APPROVED), SU MOBILE A GIORNO, PIASTRA CM.116X51 - 2 ZONE DI COTTURA (INCLUSA 1 TESTATA CHIUSURA PIANO MOD.TPA-7)

- EN** Gas Fry-top grooved chromed griddle SUPERCHROME (Moca Approved), on open cabinet, plate cm.116x51 - 2 cooking areas (included 1 Head end filler strip mod.TPA-7)
- DE** Gas-griddleplatte gerillt hartverchromt SUPERCHROME (Moca Approved), mit offenem Unterbau, platte cm.116x51 - 2 Heizzonen (inbegriffen 1 Abschluss-Element mod.TPA-7)
- FR** Plaque gaz nervurée chromée SUPERCHROME (Moca Approved), sur armoire ouvert, plaque cm.116x51 - 2 zones de cuisson (inclus 1 Élément de jonction top mod.TPA-7)

ES FRY-TOP GAS ESTRIADO CROMADO SUPERCHROME (MOCA APPROVED), SOBRE MUEBLE ABIERTO, PLANCHA CM.116X51 - 2 ZONAS DE COCCIÓN (INCLUIDA 1 CHAPA DE CIERRE PARA TOP MOD.TPA-7)

- cm. 120 x 70,5 x 90h
- cm. 123 x 77 x 111h / kg 154 / m³ 1,051

21 kW **€ 6.478,00**
18.060 kcal/h

FTL-712G3
 0823125B



FRY-TOP GAS LISCIO, SU MOBILE A GIORNO, PIASTRA CM.116X51 - 3 ZONE DI COTTURA (INCLUSA 1 TESTATA CHIUSURA PIANO MOD.TPA-7)

- EN** Gas Fry-top smooth griddle, on open cabinet, plate cm.116x51 - 3 cooking areas (included 1 Head end filler strip mod.TPA-7)
- DE** Gas-griddleplatte glatt, mit offenem Unterbau, platte cm.116x51 - 3 Heizzonen (inbegriffen 1 Abschluss-Element mod.TPA-7)
- FR** Plaque gaz lisse, sur armoire ouvert, plaque cm.116x51 - 3 zones de cuisson (inclus 1 Élément de jonction top mod.TPA-7)

ES FRY-TOP GAS LISO, SOBRE MUEBLE ABIERTO, PLANCHA CM.116X51 - 3 ZONAS DE COCCIÓN (INCLUIDA 1 CHAPA DE CIERRE PARA TOP MOD. TPA-7)

- cm. 120 x 70,5 x 90h
- cm. 123 x 77 x 111h / kg 154 / m³ 1,051

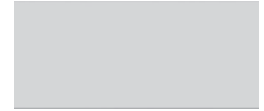
21 kW **€ 5.468,00**
18.060 kcal/h

FTL-712GS3
 0823125E

FRY-TOP GAS LISCIO CROMATO SUPERCHROME (MOCA APPROVED), SU MOBILE A GIORNO, PIASTRA CM.116X51 - 3 ZONE DI COTTURA (INCLUSA 1 TESTATA CHIUSURA PIANO MOD.TPA-7)

- EN** Gas Fry-top smooth chromed griddle SUPERCHROME (Moca Approved), on open cabinet, plate cm.116x51 - 3 cooking areas (included 1 Head end filler strip mod. TPA-7)
- DE** Gas-griddleplatte glatt hartverchromt SUPERCHROME (Moca Approved), mit offenem Unterbau, platte cm.116x51 - 3 Heizzonen (inbegriffen 1 Abschluss-Element mod.TPA-7)
- FR** Plaque gaz lisse chromée SUPERCHROME (Moca Approved), sur armoire ouvert, plaque cm.116x51 - 3 zones de cuisson (inclus 1 Élément de jonction top mod.TPA-7)

ES FRY-TOP GAS LISO CROMADO SUPERCHROME (MOCA APPROVED), SOBRE MUEBLE ABIERTO, PLANCHA CM.116X51 - 3 ZONAS DE COCCIÓN (INCLUIDA 1 CHAPA DE CIERRE PARA TOP MOD.TPA-7)

- cm. 120 x 70,5 x 90h
- cm. 123 x 77 x 111h / kg 154 / m³ 1,051

21 kW **€ 6.366,00**
18.060 kcal/h

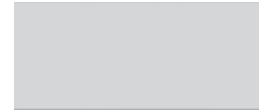
FTL-712GSS3
 0823125Y

FRY-TOP GAS LISCIO CROMO LUCIDO, SU MOBILE A GIORNO, PIASTRA CM.116X51 - 3 ZONE DI COTTURA (INCLUSA 1 TESTATA CHIUSURA PIANO MOD.TPA-7)

- EN** Gas Fry-top smooth POLISHED CHROME, on open cabinet, plate cm.116x51 - 3 cooking areas (included 1 Head end filler strip mod.TPA-7)
- DE** Gas-griddleplatte glatt POLIERTEM CHROM, mit offenem Unterbau, platte cm.116x51 - 3 Heizzonen (inbegriffen 1 Abschluss-Element mod.TPA-7)
- FR** Plaque gaz lisse CHROME POLI, sur armoire ouvert, plaque cm.116x51 - 3 zones de cuisson (inclus 1 Élément de jonction top mod.TPA-7)

ES FRY-TOP GAS LISO CROMO PULIDO, SOBRE MUEBLE ABIERTO, PLANCHA CM.116X51 - 3 ZONAS DE COCCIÓN (INCLUIDA 1 CHAPA DE CIERRE PARA TOP MOD.TPA-7)

- cm. 120 x 70,5 x 90h
- cm. 123 x 77 x 111h / kg 154 / m³ 1,051

21 kW **€ 6.366,00**
18.060 kcal/h



FTLR-712G3

0823125C



FRY-TOP GAS 1/3 RIGATO + 2/3 LISCIO, SU MOBILE A GIORNO, PIASTRA CM.116X51 - 3 ZONE DI COTTURA (INCLUSA 1 TESTATA CHIUSURA PIANO MOD.TPA-7)

- EN** Gas Fry-top 1/3 grooved + 2/3 smooth, on open cabinet, plate cm.116x51 - 3 cooking areas (included 1 Head end filler strip mod.TPA-7)
- DE** Gas-griddleplatte 1/3 gerillt + 2/3 glatt, mit offenem Unterbau, platte cm.116x51 - 3 Heizzonen (inbegriffen 1 Abschluss-Element mod.TPA-7)
- FR** Plaque gaz 1/3 nervurée + 2/3 lisse, sur armoire ouvert, plaque cm.116x51 - 3 zones de cuisson (inclus 1 Élément de jonction top mod.TPA-7)
- ES** **FRY-TOP GAS 1/3 ESTRIADO + 2/3 LISO, SOBRE MUEBLE ABIERTO, PLANCHA CM.116X51 - 3 ZONAS DE COCCIÓN (INCLUIDA 1 CHAPA DE CIERRE PARA TOP MOD.TPA-7)**

- cm. 120 x 70,5 x 90h
- cm. 123 x 77 x 111h / kg 154 / m³ 1,051

€ 5.600,00
21 kW
18.060 kcal/h

**FTLR-712GS3**

0823125F

FRY-TOP GAS 1/3 RIGATO + 2/3 LISCIO CROMATO SUPERCHROME (MOCA APPROVED), SU MOBILE A GIORNO, PIASTRA CM.116X51 - 3 ZONE DI COTTURA (INCLUSA 1 TESTATA CHIUSURA PIANO MOD.TPA-7)

- EN** Gas Fry-top 1/3 grooved + 2/3 smooth chromed SUPERCHROME (Moca Approved), on open cabinet, plate cm.116x51 - 3 cooking areas (included 1 Head end filler strip mod.TPA-7)
- DE** Gas-griddleplatte 1/3 gerillt + 2/3 glatt hartverchromt SUPERCHROME (Moca Approved), mit offenem Unterbau, platte cm.116x51 - 3 Heizzonen (inbegriffen 1 Abschluss-Element mod.TPA-7)
- FR** Plaque gaz 1/3 nervurée + 2/3 lisse chromée AW770:AW833pproved), sur armoire ouvert, plaque cm.116x51 - 3 zones de cuisson (inclus 1 Élément de jonction top mod.TPA-7)
- ES** **FRY-TOP GAS 1/3 ESTRIADO + 2/3 LISO CROMADO SUPERCHROME (MOCA APPROVED), SOBRE MUEBLE ABIERTO, PLANCHA CM.116X51 - 3 ZONAS DE COCCIÓN (INCLUIDA 1 CHAPA DE CIERRE PARA TOP MOD.TPA-7)**

- cm. 120 x 70,5 x 90h
- cm. 123 x 77 x 111h / kg 154 / m³ 1,051

€ 6.580,00
21 kW
18.060 kcal/h

**GRIGLIE ELETTRICHE**

EN ELECTRIC GRILL **DE** ELEKTRO-WURSTBRATER **FR** CHARCOAL ÉLECTRIQUE **ES** **BARBACOAS ELECTRICAS**

CWK-74ET

08080431



GRIGLIA CONTACT SU MOBILE A GIORNO - COTTURA DIRETTA SU RESISTENZA IN ACCIAIO INOX CM. 27X43 RIBALTABILE (INCLUSA 1 TESTATA CHIUSURA PIANO MOD. TPA-7)

- EN** CONTACT Grill threephase on open cabinet - rotatable stainless steel grill cm. 27x43 (included 1 Head end filler strip mod.TPA-7)
- DE** Wurstbrater dreiphasig KONTAKT mit offenem Unterbau - Drehbaren Heizelement aus Edelstahl cm. 27x43 (inbegriffen 1 Abschluss-Element mod.TPA-7)
- FR** Grillade triphase CONTACT sur armoire ouvert- Grille inox rotatif cm 27x43 (inclus 1 Élément de jonction top mod.TPA-7)
- ES** **PARRILLA TRIFÁSICO CONTACT SOBRE MUEBLE ABIERTO - PARRILLA GIRATORIA DE ACERO INOX CM 27X43 (INCLUIDA 1 CHAPA DE CIERRE PARA TOP MOD.TPA-7)**

- cm. 40 x 70,5 x 90h
- cm. 43 x 77 x 111h / kg 60 / m³ 0,368

€ 3.437,00
4,08 KW
400V~3N
50/60 Hz

CWK-78ET

08080831



GRIGLIA CONTACT SU MOBILE A GIORNO - COTTURA DIRETTA SU RESISTENZA IN ACCIAIO INOX CM. 55X43 RIBALTABILE - 2 ZONE COTTURA (INCLUSA 1 TESTATA CHIUSURA PIANO MOD.TPA-7)

- EN** CONTACT Grill threephase on open cabinet - rotatable stainless steel grill cm. 55x43 - 2 cooking areas (included 1 Head end filler strip mod.TPA-7)
- DE** Wurstbrater dreiphasig KONTAKT mit offenem Unterbau - Drehbaren Heizelement aus Edelstahl cm.. 55x43 - 2 Heizzonen (inbegriffen 1 Abschluss-Element mod.TPA-7)
- FR** Grillade triphase CONTACT sur armoire ouvert- Grille inox rotatif cm 55x43 - 2 zones de cuisson (inclus 1 Élément de jonction top mod.TPA-7)
- ES** **PARRILLA TRIFÁSICO CONTACT SOBRE MUEBLE ABIERTO - PARRILLA GIRATORIA DE ACERO INOX CM 55X43 - 2 ZONAS DE COCCIÓN (INCLUIDA 1 CHAPA DE CIERRE PARA TOP MOD.TPA-7)**

- cm. 80 x 70,5 x 90h
- cm. 83 x 77 x 111h / kg 90 / m³ 0,709

€ 4.438,00
8,16 KW
400V~3N
50/60 Hz

CW-74ET
08080430



GRIGLIA TRIFASE SU MOBILE A GIORNO GRIGLIA IN ACCIAIO INOX CM. 38X52 REGOLABILE (INCLUSA 1 TESTATA CHIUSURA PIANO MOD.TPA-7)

EN Grill threephase on open cabinet Stainless steel grill cm. 38x52 (included 1 Head end filler strip mod.TPA-7)

DE Wurstbrater dreiphasig mit offenem Unterbau Einstellbarer Rost aus Nirosta cm. 38x52 (inbegriffen 1 Abschluss-Element mod.TPA-7)

FR Grillade triphase sur armoire ouvert Grille inox cm 38x52 (inclus 1 Élément de jonction top mod.TPA-7)

ES **PARRILLA TRIFÁSICO SOBRE MUEBLE ABIERTO PARRILLA DE ACERO INOX REGULABLE CM 38X52 (INCLUIDA 1 CHAPA DE CIERRE PARA TOP MOD.TPA-7)**

cm. 40 x 70,5 x 90h
 cm. 43 x 77 x 122h / kg 62 / m³ 0,404

€ 2.644,00
6 kW
400V~3N
230V~3
50/60 Hz

CW-78ET
08080830



GRIGLIA TRIFASE SU MOBILE A GIORNO N. 2 GRIGLIE IN ACCIAIO INOX CM. 38X52 REGOLABILI 2 ZONE DI COTTURA (INCLUSA 1 TESTATA CHIUSURA PIANO MOD.TPA-7)

EN Grill threephase on open cabinet N. 2 Stainless steel grill cm. 38x52. 2 cooking areas (included 1 Head end filler strip mod.TPA-7)

DE Wurstbrater dreiphasig mit offenem Unterbau - Nr. 2 einstellbare Roste aus Nirosta cm. 38x52 - 2 Heizzonen (inbegriffen 1 Abschluss-Element mod.TPA-7)

FR Grillade triphase sur armoire ouvert N. 2 grilles réglables en acier inox cm. 38x52 2 zones de cuisson (inclus 1 Élément de jonction top mod.TPA-7)

ES **PARRILLA TRIFÁSICO SOBRE MUEBLE ABIERTO - N. 2 PARRILLAS DE ACERO INOX REGULABLE CM 38X52 - 2 ZONAS DE COCCIÓN (INCLUIDA 1 CHAPA DE CIERRE PARA TOP MOD.TPA-7)**

cm. 80 x 70,5 x 90h
 cm. 83 x 77 x 122h / kg 94 / m³ 0,780

€ 3.722,00
12 kW
400V~3N
230V~3
50/60 Hz

GRIGLIE PIETRA LAVICA A GAS

EN GAS CHARCOAL GRILL **DE** GASLAVASTEIN GRILLS **FR** CHARCOAL EN PIERRE DE LAVÈ À GAZ **ES** BARBACOAS DE PIEDRA LÁVICA A GAS

CW-74G
08250450



GRIGLIA GAS-PIETRALAVICA SU MOBILE A GIORNO GRIGLIA IN ACCIAIO INOX CM. 38X52 REGOLABILE (INCLUSA 1 TESTATA CHIUSURA PIANO MOD.TPA-7)

EN Lavastone grill gas on open cabinet Stainless steel grill cm. 38x52 (included 1 Head end filler strip mod.TPA-7)

DE Gas-Lavasteingrill mit offenem Unterbau Einstellbarer Rost aus Nirosta cm. 38x52 (inbegriffen 1 Abschluss-Element mod.TPA-7)

FR Grille à gaz en pierre de lave sur armoire ouvert Grille inox cm 38x52 (inclus 1 Élément de jonction top mod.TPA-7)

ES **PARRILLA A GAS PIEDRA LÁVICA SOBRE MUEBLE ABIERTO PARRILLA DE ACERO INOX REGULABLE CM 38X52 (INCLUIDA 1 CHAPA DE CIERRE PARA TOP MOD.TPA-7)**

cm. 40 x 70,5 x 90h
 cm. 43 x 77 x 122h / kg 61 / m³ 0,404

€ 2.676,00
9 kW
7.740 kcal/h

CW-78G
08250850



GRIGLIA GAS-PIETRALAVICA SU MOBILE A GIORNO N. 2 GRIGLIE IN ACCIAIO INOX CM. 38X52 REGOLABILI 2 ZONE DI COTTURA. (INCLUSA 1 TESTATA CHIUSURA PIANO MOD. TPA-7)

EN Lavastone grill gas on open cabinet N. 2 Stainless steel grill cm. 38x52. 2 cooking areas (included 1 Head end filler strip mod.TPA-7)

DE Gas-Lavasteingrill mit offenem Unterbau - N. 2 einstellbare Roste aus Nirosta cm. 38x52 - 2 Heizzonen (inbegriffen 1 Abschluss-Element mod.TPA-7)

FR Grille a gaz en pierre de lave sur armoire ouvert. N. 2 grilles réglables en acier inox cm. 38x52. 2 zones de cuisson (inclus 1 Élément de jonction top mod.TPA-7)

ES **PARRILLA A GAS PIEDRA LÁVICA SOBRE MUEBLE ABIERTO N. 2 PARRILLAS DE ACERO INOX REGULABLE CM 38X52 2 ZONAS DE COCCIÓN (INCLUIDA 1 CHAPA DE CIERRE PARA TOP MOD.TPA-7)**

cm. 80 x 70,5 x 90h
 cm. 83 x 77 x 122h / kg 104 / m³ 0,780

€ 4.023,00
18 kW
15.480 kcal/h

FRIGGITRICI ELETTRICHE

EN ELECRTIC FRYERS DE ELEKTRO-FRITEUSE FR FRITEUSE ÉLECTRIQUE ES FREIDORAS ELECTRICAS

F2/8-74ET
 08090432

FRIGGITRICE TRIFASE LT. 8+8 2 VASCHE CM. 14,8X35X32,7H - 2 CESTI CM. 12X30X15H - FILTRO E COPERCHIO VASCA. 2 BACINELLE RACCOGLIOLIO CON FILTRO. PRODUZIONE PATATE: 12 KG/H (INCLUSA 1 TESTATA CHIUSURA PIANO MOD.TPA-7)

EN Fryer threephase 8+8 lts - 2 Bowls cm. 14,8x35x32,7h - 2 baskets cm. 12x30x15h. Sieve and lid for pan. 2 drip tray with sieves. Production: 12 kg/h (included 1 Head end filler strip mod.TPA-7)

DE Friteuse dreiphasig lt. 8+8 - 2 Becken cm. 14,8x35x32,7h - 2 Korb cm. 12x30x15h. Einlegesieb und Deckel für Becken. 2 Fettauffangschalen mit Sieb. Pommes frites: 12 kg/h (inbegriffen 1 Abschluss-Element mod.TPA-7)

FR Friteuse triphase lt. 8+8 - 2 Cuve cm. 14,8x35x32,7h - 2 Panier cm. 12x30x15h. Filtre, couvercle pour cuve. 2 bacs de récupération de l'huile avec filtre. Production de pommes frites: 12 kg/h (inclus 1 Élément de jonction top mod.TPA-7)

ES FREIDORAS TRIFÁSICO 8+8 LT. - 2CUBA CM. 14,8X35X32,7H - 2 CESTA CM. 12X30X15H. FILTRO Y TAPA PARA CUBA. 2 BANDEJAS RECOGE ACEITE CON FILTRO. PROD. PATATAS: 12 KG/H (INCLUIDA 1 CHAPA DE CIERRE PARA TOP MOD.TPA-7)

cm. 40 x 70,5 x 90h

cm. 43 x 77 x 111h / kg 59 / m³ 0,368

12 kW
400V~3N
230V~3
50/60 Hz

€ 3.879,00

F13-74ET
 08090430

FRIGGITRICE TRIFASE LT. 13 VASCA CM. 24X35X33H - 1 CESTO CM. 21X30X12H - FILTRO E COPERCHIO VASCA. BACINELLA RACCOGLIOLIO CON FILTRO. PRODUZIONE PATATE: 10 KG/H (INCLUSA 1 TESTATA CHIUSURA PIANO MOD.TPA-7)

EN Fryer threephase 13 lts - Bowl cm. 24x35x33h - 1 basket cm. 21x30x12h. Sieve and lid for pan. Drip tray with sieve. Production: 10 kg/h (included 1 Head end filler strip mod.TPA-7)

DE Friteuse dreiphasig lt. 13 - Becken cm. 24x35x33h - 1 Korb cm. 21x30x12h. Einlegesieb und Deckel für Becken. Fettauffangschale mit Sieb. Pommes frites: 10 kg/h (inbegriffen 1 Abschluss-Element mod.TPA-7)

FR Friteuse triphase lt. 13 - Cuve cm. 24x35x33h - 1 Panier cm. 21x30x12h. Filtre, couvercle pour cuve. Bac de récupération de l'huile avec filtre. Production de pommes frites: 10 kg/h (inclus 1 Élément de jonction top mod.TPA-7)

ES FREIDORAS TRIFÁSICO 13 LT. - CUBA CM. 24X35X33H - 1 CESTA CM. 21X30X12H. FILTRO Y TAPA PARA CUBA. BANDEJA RECOGE ACEITE CON FILTRO. PROD. PATATAS: 10 KG/H (INCLUIDA 1 CHAPA DE CIERRE PARA TOP MOD.TPA-7)

cm. 40 x 70,5 x 90h

cm. 43 x 77 x 111h / kg 54 / m³ 0,368

10,95 kW
400V~3N
50/60 Hz

€ 2.797,00

F18-74ET
 08090431

FRIGGITRICE TRIFASE LT. 18 VASCA CM. 31X34X33H - 1 CESTO CM. 28X29X15H - FILTRO E COPERCHIO VASCA. BACINELLA RACCOGLIOLIO CON FILTRO. PRODUZIONE PATATE: 15 KG/H (INCLUSA 1 TESTATA CHIUSURA PIANO MOD.TPA-7)

EN Fryer threephase 18 lts - Bowl cm. 31x34x33h - 1 basket cm. 28x29x15h. Sieve and lid for pan. Drip tray with sieve. Production: 15 kg/h (included 1 Head end filler strip mod.TPA-7)

DE Friteuse dreiphasig lt. 18 - Becken cm. 31x34x33h - 1 Korb cm. 28x29x15h. Einlegesieb und Deckel für Becken. Fettauffangschale mit Sieb. Pommes frites: 15 kg/h (inbegriffen 1 Abschluss-Element mod.TPA-7)

FR Friteuse triphase lt. 18 - Cuve cm. 31x34x33h - 1 Panier cm. 28x29x15h. Filtre, couvercle pour cuve. Bac de récupération de l'huile avec filtre. Production de pommes frites: 15 kg/h (inclus 1 Élément de jonction top mod.TPA-7)

ES FREIDORAS TRIFÁSICO 18 LT. - CUBA CM. 31X34X33H - 1 CESTA CM. 28X29X15H. FILTRO Y TAPA PARA CUBA. BANDEJA RECOGE ACEITE CON FILTRO. PROD. PATATAS: 15 KG/H (INCLUIDA 1 CHAPA DE CIERRE PARA TOP MOD.TPA-7)

cm. 40 x 70,5 x 90h

cm. 43 x 77 x 111h / kg 57 / m³ 0,368

15,9 kW
400V~3N
50/60 Hz

€ 3.028,00

F2/13-78ET

08090830



FRIGGITRICE TRIFASE LT. 13+13 2 VASCHE CM. 24X35X33H - 2 CESTI CM. 21X30X12H 2 FILTRI E COPERCHI VASCHE. 2 BACINELLE RACCOGLIOLIO CON FILTRO. PRODUZIONE PATATE: 20 KG/H (INCLUSA 1 TESTATA CHIUSURA PIANO MOD.TPA-7)

EN Fryer threephase 13+13 lts - 2 pans cm. 24x35x33h 2 baskets cm. 21x30x12h. 2 sieve and lids for pan. 2 drip trays with sieves. Production: 20 kg/h (included 1 Head end filler strip mod.TPA-7)

DE Friteuse dreiphasig lt. 13+13 - 2 Becken cm. 24x35x33h 2 Körbe cm. 21x30x12h. Einlegesieb und Deckel für Becken. 2 Fettauffangschalen mit Sieb. Pommes frites: 20 kg/h (inbegriffen 1 Abschluss-Element mod.TPA-7)

FR Friteuse triphase lt. 13+13 - 2 cuves cm. 24x35x33h 2 paniers cm. 21x30x12h. 2 filtres, couvercles pour cuve. 2 bacs de récupération de l'huile avec filtre. Production de pommes frites: 20 kg/h (inclus 1 Élément de jonction top mod.TPA-7)

ES FREIDORAS TRIFÁSICO 13+13 LT. - 2 CUBAS CM. 24X35X33H 2 CESTAS CM. 21X30X12H. 2 FILTROS Y TAPAS PARA CUBA. 2 BANDEJAS RECOGE ACEITE CON FILTRO. PROD. PATATAS: 20 KG/H (INCLUIDA 1 CHAPA DE CIERRE PARA TOP MOD.TPA-7)

cm. 80 x 70,5 x 90h

cm. 83 x 77 x 111h / kg 95 / m³ 0,709

21,9 kW
400V~3N
50/60 Hz

€ 4.187,00
F2/18-78ET

08090831



FRIGGITRICE TRIFASE LT. 18+18 2 VASCHE CM. 31X34X33H - 2 CESTI CM. 28X29X15H 2 FILTRI E COPERCHI VASCHE. 2 BACINELLE RACCOGLIOLIO CON FILTRO. PRODUZIONE PATATE: 30 KG/H (INCLUSA 1 TESTATA CHIUSURA PIANO MOD.TPA-7)

EN Fryer threephase 18+18 lts - 2 pans cm. 31x34x33h 2 baskets cm. 28x29x15h. 2 sieve and lids for pan. 2 drip trays with sieves. Production: 30 kg/h (included 1 Head end filler strip mod.TPA-7)

DE Friteuse dreiphasig lt. 18+18 - 2 Becken cm. 31x34x33h 2 Körbe cm. 28x29x15h. Einlegesieb und Deckel für Becken. 2 Fettauffangschalen mit Sieb. Pommes frites: 30 kg/h (inbegriffen 1 Abschluss-Element mod.TPA-7)

FR Friteuse triphase lt. 18+18 - 2 cuves cm. 31x34x33h 2 paniers cm. 28x29x15h. 2 filtres, couvercles pour cuve. 2 bacs de récupération de l'huile avec filtre. Production de pommes frites: 30 kg/h (inclus 1 Élément de jonction top mod.TPA-7)

ES FREIDORAS TRIFÁSICO 18+18 LT. - 2 CUBAS CM. 31X34X33H 2 CESTAS CM. 28X29X15H. 2 FILTROS Y TAPAS PARA CUBA. 2 BANDEJAS RECOGE ACEITE CON FILTRO. PROD. PATATAS: 30 KG/H (INCLUIDA 1 CHAPA DE CIERRE PARA TOP MOD.TPA-7)

cm. 80 x 70,5 x 90h

cm. 83 x 77 x 111h / kg 97 / m³ 0,709

31,8 kW
400V~3N
50/60 Hz

€ 4.657,00
F45-78ET

08090835



FRIGGITRICE TRIFASE LT. 45 VASCA CM. 70X38X38H - 1 CESTO CM. 65X33X17H - FILTRO E COPERCHIO VASCA. BACINELLA RACCOGLIOLIO CON FILTRO. PRODUZIONE PATATE: 40 KG/H (INCLUSA 1 TESTATA CHIUSURA PIANO MOD.TPA-7)

EN Fryer threephase 45 lts - Bowl cm. 70x38x38h - 1 basket cm. 65x33x17h. Sieve and lid for pan. Drip tray with sieve. Production: 40 kg/h (included 1 Head end filler strip mod.TPA-7)

DE Friteuse dreiphasig lt. 45 - Becken cm. 70x38x38h - 1 Korb cm. 65x33x17h. Einlegesieb und Deckel für Becken. Fettauffangschale mit Sieb. Pommes frites: 40 kg/h (inbegriffen 1 Abschluss-Element mod.TPA-7)

FR Friteuse triphase lt. 45 - Cuve cm. 70x38x38h - 1 Panier cm. 65x33x17h. Filtre, couvercle pour cuve. Bac de récupération de l'huile avec filtre. Production de pommes frites: 40 kg/h (inclus 1 Élément de jonction top mod.TPA-7)

ES FREIDORAS TRIFÁSICO 45 LT. - CUBA CM. 70X38X38H - 1 CESTA CM. 65X33X17H. FILTRO Y TAPA PARA CUBA. BANDEJA RECOGE ACEITE CON FILTRO. PROD. PATATAS: 40 KG/H (INCLUIDA 1 CHAPA DE CIERRE PARA TOP MOD.TPA-7)

cm. 80 x 70,5 x 90h

cm. 83 x 77 x 111h / kg 96 / m³ 0,709

40 kW
400V~3N
50/60 Hz

€ 5.289,00

FRIGGITRICI A GAS

EN GAS FRYERS DE GAS-FRITEUSE FR FRITEUSE À GAZ ES FREIDORAS A GAS

F2/8-74G

08260452



FRIGGITRICE GAS LT. 8+8 - 2 VASCHE CM. 15X35X36H 2 CESTI CM. 12X30X15H. FILTRO E COPERCHIO VASCA. 2 BACINELLE RACCOGLIOLIO CON FILTRO. PROD. PATATE: 12 KG/H (INCLUSA 1 TESTATA CHIUSURA PIANO MOD.TPA-7)

EN Gas Fryer 8+8 lts - 2 pans cm. 15x35x36h 2 baskets cm. 12x30x15h. Sieve and lid for pan. 2 drip trays with sieves. Production: 12 kg/h (included 1 Head end filler strip mod.TPA-7)

DE Gas-Friteuse lt. 8+8 - 2 Becken cm. 15x35x36h 2 Körbe cm. 12x30x15h. Einlegesieb und Deckel für Becken. 2 Fettauffangschalen mit Sieb. Pommes frites: 12 kg/h (inbegriffen 1 Abschluss-Element mod.TPA-7)

FR Friteuse à gaz lt. 8+8 - 2 cuves cm. 15x35x36h 2 paniers cm. 12x30x15h. Filtre, couvercle pour cuve. 2 bacs de récupération de l'huile avec filtre. Production de pommes frites: 12 kg/h (inclus 1 Élément de jonction top mod.TPA-7)

ES FREIDORAS A GAS 8+8 LT. - 2 CUBAS CM. 15X35X36H 2 CESTAS CM. 12X30X15H. FILTRO Y TAPA PARA CUBA. 2 BANDEJAS RECOGE ACEITE CON FILTRO. PROD. PATATAS: 12 KG/H (INCLUIDA 1 CHAPA DE CIERRE PARA TOP MOD.TPA-7)

cm. 40 x 70,5 x 90h

cm. 43 x 77 x 111h / kg 59 / m³ 0,368

10 kW
8.600 kcal/h

€ 4.486,00

F13-74G

08260450



FRIGGITRICE GAS LT. 13 VASCA CM. 24X35X38H - 1 CESTO CM. 21X30X12H. FILTRO E COPERCHIO VASCA. BACINELLA RACCOGLIOLIO CON FILTRO. PROD. PATATE: 10 KG/H (INCLUDE ENTRAMBE LE TESTATE CHIUSURA PIANO)

EN Gas Fryer 13 lts - Bowl cm. 24x35x38h - 1 basket cm. 21x30x12h. Sieve and lid for pan. Drip tray with sieve. Production: 10 kg/h (included both Heads end filler strip)

DE Gas-Friteuse lt. 13 - Becken cm. 24x35x38h - 1 Korb cm. 21x30x12h. Einlegesieb und Deckel für Becken. Fettauffangschale mit Sieb. Pommes frites: 10 kg/h (inbegriffen alle 2 Abschluss-Element)

FR Friteuse a gaz lt. 13 - Cuve cm. 24x35x38h - 1 Panier cm. 21x30x12h. Filtre, couvercle pour cuve. Bac de récupération de l'huile avec filtre. Production de pommes frites: 10 kg/h (inclus tous 2 Élément de jonction top)

ES FREIDORAS A GAS 13 LT. - CUBA CM. 24X35X38H - 1 CESTA CM. 21X30X12H. FILTRO Y TAPA PARA CUBA. BANDEJA RECOGE ACEITE CON FILTRO. PROD. PATATAS: 10 KG/H (INCLUIDAS TODAS LAS 2 CHAPA DE CIERRE PARA TOP)

cm. 40 x 70,5 x 90h

cm. 43 x 77 x 122h / kg 61 / m³ 0,404

9,3 kW
8.000 kcal/h

€ 2.846,00

F18-74G

08260451



FRIGGITRICE GAS LT. 18 VASCA CM. 33X38X38H. - 1 CESTO CM. 30X33X12H. FILTRO E COPERCHIO VASCA. BACINELLA RACCOGLIOLIO CON FILTRO. PROD. PATATE: 15 KG/H (INCLUDE ENTRAMBE LE TESTATE CHIUSURA PIANO)

EN Gas Fryer 18 lts - Bowl cm. 33x38x38h - 1 basket cm. 30x33x12h. Sieve and lid for pan. Drip tray with sieve. Production: 15 kg/h (included both Heads end filler strip)

DE Gas-Friteuse lt. 18 - Becken cm. 33x38x38h - 1 Korb cm. 30x33x12h. Einlegesieb und Deckel für Becken. Fettauffangschale mit Sieb. Pommes frites: 15 kg/h (inbegriffen alle 2 Abschluss-Element)

FR Friteuse a gaz lt. 18 - Cuve cm. 33x38x38h 1 Panier cm. 30x33x12h. Filtre, couvercle pour cuve. - Bac de récupération de l'huile avec filtre. Production de pommes frites: 15 kg/h (inclus tous 2 Élément de jonction top)

ES FREIDORAS A GAS 18 LT. - CUBA CM. 33X38X38H - 1 CESTA CM. 30X33X12H. FILTRO Y TAPA PARA CUBA. BANDEJA RECOGE ACEITE CON FILTRO. PROD. PATATAS: 15 KG/H (INCLUIDAS TODAS LAS 2 CHAPA DE CIERRE PARA TOP)

cm. 40 x 70,5 x 90h

cm. 43 x 77 x 122h / kg 66 / m³ 0,404

13,5 kW
11.610 kcal/h

€ 3.170,00

F2/13-78G

08260850



FRIGGITRICE GAS LT. 13+13 - 2 VASCHE CM. 24X35X38H 2 CESTI CM. 21X30X12H. 2 FILTRI E COPERCHI VASCHE. 2 BACINELLE RACCOGLIOLIO CON FILTRO. PROD. PATATE: 20 KG/H (INCLUDE ENTRAMBE LE TESTATE CHIUSURA PIANO)

EN Gas Fryer 13+13 lts - 2 pans cm. 24x35x38h 2 baskets cm. 21x30x12h. 2 sieve and lids for pan. 2 drip trays with sieves. Production: 20 kg/h (included both Heads end filler strip)

DE Gas-Friteuse lt. 13+13 - 2 Becken cm. 24x35x38h 2 Körbe cm. 21x30x12h. Einlegesieb und Deckel für Becken. 2 Fettauffangschalen mit Sieb. Pommes frites: 20 kg/h (inbegriffen alle 2 Abschluss-Element)

FR Friteuse à gaz lt. 13+13 - 2 cuves cm. 24x35x38h 2 paniers cm. 21x30x12h. 2 filtres, couvercles pour cuve. 2 bacs de récupération de l'huile avec filtre. Production de pommes frites: 20 kg/h (inclus tous 2 Élément de jonction top)

ES FREIDORAS A GAS 13+13 LT. - 2 CUBAS CM. 24X35X38H 2 CESTAS CM. 21X30X12H. 2 FILTROS Y TAPAS PARA CUBAS. 2 BANDEJAS RECOGE ACEITE CON FILTRO. PROD. PATATAS: 20 KG/H (INCLUIDAS TODAS LAS 2 CHAPA DE CIERRE PARA TOP)

cm. 80 x 70,5 x 90h

cm. 83 x 77 x 122h / kg 102 / m³ 0,780

18,6 kW
16.000 kcal/h

€ 5.048,00

F2/18-78G

08260851



FRIGGITRICE GAS LT. 18+18 - 2 VASCHE CM. 33X38X38H 2 CESTI CM. 30X33X12H. 2 FILTRI E COPERCHI VASCHE. 2 BACINELLE RACCOGLIOLIO CON FILTRO. PROD. PATATE: 30 KG/H (INCLUDE ENTRAMBE LE TESTATE CHIUSURA PIANO)

EN Gas Fryer 18+18 lts - 2 pans cm. 33x38x38h 2 baskets cm. 30x33x12h. 2 sieve and lids for pan. 2 drip trays with sieves. Production: 30 kg/h (included both Heads end filler strip)

DE Gas-Friteuse lt. 18+18 - 2 Becken cm. 33x38x38h 2 Körbe cm. 30x33x12h. Einlegesieb und Deckel für Becken. 2 Fettauffangschalen mit Sieb. Pommes frites: 30 kg/h (inbegriffen alle 2 Abschluss-Element)

FR Friteuse à gaz lt. 18+18 - 2 cuves cm. 33x38x38h 2 paniers cm. 30x33x12h. 2 filtres, couvercles pour cuve. 2 bacs de récupération de l'huile avec filtre. Production de pommes frites: 30 kg/h (inclus tous 2 Elément de jonction top)

ES FREIDORAS A GAS 18+18 LT. - 2 CUBAS CM. 33X38X38H 2 CESTAS CM. 30X33X12H. 2 FILTROS Y TAPAS PARA CUBA. 2 BANDEJAS RECOGE ACEITE CON FILTRO. PROD. PATATAS: 30 KG/H (INCLUIDAS TODAS LAS 2 CHAPA DE CIERRE PARA TOP)

cm. 80 x 70,5 x 90h

cm. 83 x 77 x 122h / kg 111 / m³ 0,780

27 kW
23.220 kcal/h

€ 5.556,00
F45-78G

08260855



FRIGGITRICE GAS LT. 45 VASCA CM. 70X38X38H. - 1 CESTO CM. 65X33X17H. FILTRO E COPERCHIO VASCA. BACINELLA RACCOGLIOLIO CON FILTRO. PROD. PATATE: 40 KG/H (INCLUDE ENTRAMBE LE TESTATE CHIUSURA PIANO)

EN Gas Fryer 45 lts - Bowl cm. 70x38x38h - 1 basket cm. 65x33x17h. Sieve and lid for pan. Drip tray with sieve. Production: 40 kg/h (included both Heads end filler strip)

DE Gas-Friteuse lt. 45 - Becken cm. 70x38x38h - 1 Korb cm. 65x33x17h. Einlegesieb und Deckel für Becken. Fettauffangschale mit Sieb. Pommes frites: 40 kg/h (inbegriffen alle 2 Abschluss-Element)

FR Friteuse a gaz lt. 45 - Cuve cm. 70x38x38h - 1 Panier cm. 65x33x17h. Filtre, couvercle pour cuve. Bac de récupération de l'huile avec filtre. Production de pommes frites: 40 kg/h (inclus tous 2 Elément de jonction top)

ES FREIDORAS A GAS 45 LT. - CUBA CM. 70X38X38H - 1 CESTA CM. 65X33X17H. FILTRO Y TAPA PARA CUBA. BANDEJA RECOGE ACEITE CON FILTRO. PROD. PATATAS: 40 KG/H (INCLUIDAS TODAS LAS 2 CHAPA DE CIERRE PARA TOP)

cm. 80 x 70,5 x 90h

cm. 87 x 81 x 152h / kg 110 / m³ 1,071

44 kW
37.840 kcal/h

€ 6.283,00

0,005 kW
230V~
50 Hz

F18-74GVP

08330451



FRIGGITRICE GAS. VASCA 18 LITRI CM.31X34X42H CON BRUCIATORI ESTERNI. 1 CESTO CM.27X28X15H. FILTRO E COPERCHIO VASCA. PRODUZIONE PATATE: 18 KG/H (BACINELLA RACCOGLIOLIO ESCLUSA, VEDI MOD: BF25) (INCLUSA 1 TESTATA CHIUSURA PIANO MOD.TPA-7)

EN Gas Fryer. Bowl 18 lts cm.31x34x42h with external burners. 1 basket cm. 27x28x15h. Sieve and lid for pan. Production: 18 kg/h (Drip tray excluded, see mod: BF25) (included 1 Head end filler strip mod.TPA-7)

DE Gas-Friteuse. Becken 18 lt. cm.31x34x42h mit externe Brenner. 1 Korb cm. 27x28x15h. Einlegesieb und Deckel für Becken. Pommes frites: 18 kg/h (Fettauffangschale ausgeschlossen, sehen mod: BF25) (inbegriffen 1 Abschluss-Element mod.TPA-7)

FR Friteuse a gaz. Cuve 18 lt. cm.31x34x42h avec bruleurs externes. 1 Panier cm. 27x28x15h. Filtre, couvercle pour cuve. Production de pommes frites: 18 kg/h (Bac de récupération de l'huile exclus, voir mod: BF25) (inclus 1 Elément de jonction top mod.TPA-7)

ES FREIDORAS A GAS. CUBA DE 18 LITROS CM. 31X34X42H CON QUEMADORES EXTERNOS. 1 CESTA CM. 27X28X15H. FILTRO Y TAPA PARA CUBA. PROD. PATATAS: 18 KG/H (BANDEJA RECOGE ACEITE EXCLUIDA, VER MOD: BF25) (INCLUIDA 1 CHAPA DE CIERRE PARA TOP MOD.TPA-7)

cm. 40 x 70,5 x 90h

cm. 43 x 77 x 111h / kg 66 / m³ 0,368

18 kW
15.480 kcal/h

€ 3.687,00
F2/18-78GVP

08330851



FRIGGITRICE GAS. 2 VASCHE 18 LITRI CM.31X34X42H CON BRUCIATORI ESTERNI. 2 CESTI CM.27X28X15. FILTRO E COPERCHIO VASCA. PRODUZIONE PATATE: 36 KG/H (BACINELLA RACCOGLIOLIO ESCLUSA, VEDI MOD: BF25) (INCLUSA 1 TESTATA CHIUSURA PIANO MOD. TPA-7)

EN Gas Fryer. 2 bowls 18 lts cm.31x34x42h with external burners. 2 baskets cm. 27x28x15h. 2 sieve and lids for pan. Production: 36 kg/h (Drip tray excluded, see mod: BF25) (included 1 Head end filler strip mod.TPA-7)

DE Gas-Friteuse. 2 Becken 18 lt cm.31x34x42h mit externe Brenner. 2 Körbe cm. 27x28x15h. 2 Einlegesieb und Deckel für Becken. Pommes frites: 36 kg/h (Fettauffangschale ausgeschlossen, sehen mod: BF25) (inbegriffen 1 Abschluss-Element mod.TPA-7)

FR Friteuse a gaz. 2 cuves 18 lt cm.31x34x42h avec bruleurs externes. 2 paniers cm. 27x28x15h. 2 filtres, couvercles pour cuve. Production de pommes frites: 36 kg/h (Bac de récupération de l'huile exclus, voir mod: BF25) (inclus 1 Elément de jonction top mod.TPA-7)

ES FREIDORAS A GAS. 2 CUBAS DE 18 LITROS CM. 31X34X42H CON QUEMADORES EXTERNOS. 2 CESTAS CM. 27X28X15H. 2 FILTROS Y TAPAS PARA CUBA. PROD. PATATAS: 36 KG/H (BANDEJA RECOGE ACEITE EXCLUIDA, VER MOD: BF25) (INCLUIDA 1 CHAPA DE CIERRE PARA TOP MOD.TPA-7)

cm. 80 x 70,5 x 90h

cm. 83 x 77 x 111h / kg 111 / m³ 0,709

36 kW
30.960 kcal/h

€ 6.778,00

FRIGGITRICI ELETTRICHE DIGITALI

EN ELECTRIC ELECTRONIC FRYER DE ELEKTRONISCHE ELEKTRISCHE FRITEUSE FR FRITEUSE ÉLECTRIQUE ÉLECTRONIQUE ES FREIDORA ELÉCTRICA ELECTRÓNICA

F18-74ETD

0815A430



FRIGGITRICE ELETTRICA ELETTRONICA CON TOUCHSCREEN 7". CONSERVAZIONE A 110 °C O PRELAVORO A 160 °C CON O SENZA MELTING. POSSIBILITÀ DI INSERIRE IN MEMORIA FINO A 100 PROGRAMMI. SENSORE PRESENZA E LIVELLO MASSIMO OLIO. VASCA 18 LITRI CM.31X34X33H - 2 CESTI CM.13,5X29X21H - FILTRO E COPERCHIO VASCA. BACINELLA RACCOLTA OLIO CON SUPPORTO SU RUOTE. PRODUZIONE PATATE: 23 KG/H (INCLUDE ENTRAMBE LE TESTATE CHIUSURA PIANO)

EN Electric electronic Fryer with a 7" TouchScreen. Conservation at 110 °C and preworking at 160 °C with or without Melting. Possibility to store in the memory up to 100 programs. Oil presence sensor and maximum level sensor. Bowl 18 lts cm.31x34x33h - 2 baskets cm.13,5x29x21h. Sieve and lid for pan. Oil collection basin with support on wheels. Production: 23 kg/h (included both Heads end filler strip)

DE ELEKTRONISCHE ELEKTRISCHE FRITEUSE mit TouchScreen 7". Aufbewahrung bei 110 °C oder Vorbereitung bei 160 °C mit oder ohne Melting. Es können bis zu 100 Programme gespeichert werden. Anwesenheits- sowie maximaler Ölstandsensor. Becken 18 lt. cm.31x34x33h - 2 Körbe cm.13,5x29x21h. Einlegesieb und Deckel für Becken. Ölauffangbecken mit Halterung auf Rädern. Pommes frites: 23 kg/h (inbegriffen alle 2 Abschluss-Element)

FR FRITEUSE ÉLECTRIQUE ÉLECTRONIQUE à Écran tactile 7". Conservation à 110 °C ou Pré-traitement à 160 °C avec ou sans Melting. Possibilité d'enregistrer jusqu'à 100 programmes en mémoire. Capteur de présence et de niveau maximal huile. Cuve 18 lt. cm.31x34x33h - 2 Paniers cm.13,5x29x21h. Filtre, couvercle pour cuve. Bassine de collecte de l'huile avec support sur roues. Production de pommes frites: 23 kg/h (inclus tous 2 Elément de jonction top)

ES FREIDORA ELÉCTRICA ELECTRÓNICA CON PANTALLA TÁCTIL DE 7". CONSERVACIÓN A 110 °C O TRABAJO PREVIO A 160 °C CON O SIN FUSIÓN. SE PUEDEN ALMACENAR HASTA 100 PROGRAMAS EN LA MEMORIA. SENSOR DE PRESENCIA Y NIVEL MÁXIMO DE ACEITE. CUBA DE 18 LITROS CM. 31X34X33H - 2 CESTAS CM.13,5X29X21H. FILTRO Y TAPA PARA CUBA. CUBETA DE RECOGIDA DE ACEITE CON SOPORTE SOBRE RUEDAS. PROD. PATATAS: 23 KG/H (INCLUIDAS TODAS LAS 2 CHAPA DE CIERRE PARA TOP)

cm. 40 x 70,5 x 90h

cm. 43 x 77 x 122h / kg 63 / m³ 0,404

15,95 kW
400V~3N
50/60 Hz

€ 6.906,00

F18-74ETDP

0815A431

FRIGGITRICE ELETTRICA ELETTRONICA CON TOUCHSCREEN 7". CONSERVAZIONE A 110 °C O PRELAVORO A 160 °C CON O SENZA MELTING. POSSIBILITÀ DI INSERIRE IN MEMORIA FINO A 100 PROGRAMMI. SENSORE PRESENZA E LIVELLO MASSIMO OLIO. POMPA FILTRAGGIO OLIO A CALDO MAX 180°C, PULIZIA VASCA, SVUOTAMENTO VASCA. VASCA 18 LITRI CM.31X34X33H - 2 CESTI CM.13,5X29X21H - FILTRO E COPERCHIO VASCA. BACINELLA RACCOLTA OLIO CON SUPPORTO SU RUOTE E FILTRO 5 MICRON (PZ.100 INCLUSI). PRODUZIONE PATATE: 23 KG/H (INCLUDE ENTRAMBE LE TESTATE CHIUSURA PIANO)

EN Electric electronic Fryer with a 7" TouchScreen. Conservation at 110 °C and preworking at 160 °C with or without Melting. Possibility to store in the memory up to 100 programs. Oil presence sensor and maximum level sensor. Pump for filter the hot oil max 180°C, Tank cleaning, Tank emptying. Bowl 18 lts cm.31x34x33h - 2 baskets cm.13,5x29x21h. Sieve and lid for pan. Oil collection basin with support on wheels with sieve 5 microns (pcs.100 included). Production: 23 kg/h (included both Heads end filler strip)

DE ELEKTRONISCHE ELEKTRISCHE FRITEUSE mit TouchScreen 7". Aufbewahrung bei 110 °C oder Vorbereitung bei 160 °C mit oder ohne Melting. Es können bis zu 100 Programme gespeichert werden. Anwesenheits- sowie maximaler Ölstandsensor. Heißölfilterpumpe max 180°C, Tankreinigung, Tankentleerung. Becken 18 lt. cm.31x34x33h - 2 Körbe cm.13,5x29x21h. Einlegesieb und Deckel für Becken. Ölauffangbecken mit Halterung auf Rädern und 5-Mikron-Filter (Stk.100 inbegriffen). Pommes frites: 23 kg/h (inbegriffen alle 2 Abschluss-Element)

FR FRITEUSE ÉLECTRIQUE ÉLECTRONIQUE à Écran tactile 7". Conservation à 110 °C ou Pré-traitement à 160 °C avec ou sans Melting. Possibilité d'enregistrer jusqu'à 100 programmes en mémoire. Capteur de présence et de niveau maximal huile. Pompe filtration huile à chaud max 180°C, nettoyage cuve, vidange cuve. Cuve 18 lt. cm.31x34x33h - 2 Paniers cm.13,5x29x21h. Filtre, couvercle pour cuve. Bassine de collecte de l'huile avec support sur roues et filtre 5 microns (pcs.100 inclus). Production de pommes frites: 23 kg/h (inclus tous 2 Elément de jonction top)

ES FREIDORA ELÉCTRICA ELECTRÓNICA CON PANTALLA TÁCTIL DE 7". CONSERVACIÓN A 110 °C O TRABAJO PREVIO A 160 °C CON O SIN FUSIÓN. SE PUEDEN ALMACENAR HASTA 100 PROGRAMAS EN LA MEMORIA. SENSOR DE PRESENCIA Y NIVEL MÁXIMO DE ACEITE. BOMBA DE FILTRADO DE ACEITE CALIENTE, MÁXIMO 180 °C, LIMPIEZA DEL TANQUE, VACIADO DEL TANQUE. CUBA DE 18 LITROS CM. 31X34X33H - 2 CESTAS CM.13,5X29X21H. FILTRO Y TAPA PARA CUBA. CUBETA DE RECOGIDA DE ACEITE CON SOPORTE SOBRE RUEDAS Y FILTRO DE 5 MICRONES (PZ.100 INCLUIDA). PROD. PATATAS: 23 KG/H (INCLUIDAS TODAS LAS 2 CHAPA DE CIERRE PARA TOP)

cm. 40 x 70,5 x 90h

cm. 43 x 77 x 122h / kg 73 / m³ 0,404

16,2 kW
400V~3N
50/60 Hz

€ 10.228,00

F18-74ETDPS

0815A432



FRIGGITRICE ELETTRICA ELETTRONICA CON TOUCHSCREEN 7". CONSERVAZIONE A 110 °C O PRELAVORO A 160 °C CON O SENZA MELTING. POSSIBILITÀ DI INSERIRE IN MEMORIA FINO A 100 PROGRAMMI. SENSORE PRESENZA E LIVELLO MASSIMO OLIO. POMPA FILTRAGGIO OLIO A CALDO MAX 180°C, PULIZIA VASCA, SVUOTAMENTO VASCA. 2 SOLLEVATORI CESTI INTEGRATI. VASCA 18 LITRI CM.31X34X33H - 2 CESTI CM.13,5X29X21H - FILTRO E COPERCHIO VASCA. BACINELLA RACCOLTA OLIO CON SUPPORTO SU RUOTE E FILTRO 5 MICRON (PZ.100 INCLUSI). PRODUZIONE PATATE: 23 KG/H (INCLUSE ENTRAMBE LE TESTATE CHIUSURA PIANO)

16,55 kW
400V~3N
50/60 Hz

€ 12.740,00

EN Electric electronic Fryer with a 7" TouchScreen. Conservation at 110 °C and preworking at 160 °C with or without Melting. Possibility to store in the memory up to 100 programs. Oil presence sensor and maximum level sensor. Pump for filter the hot oil max 180°C, Tank cleaning, Tank emptying. 2 Lifter for baskets integrated. Bowl 18 lts cm.31x34x33h - 2 baskets cm.13,5x29x21h. Sieve and lid for pan. Oil collection basin with support on wheels with sieve 5 microns (pcs.100 included). Production: 23 kg/h (included both Heads end filler strip)

DE ELEKTRONISCHE ELEKTRISCHE FRITEUSE mit TouchScreen 7". Aufbewahrung bei 110 °C oder Vorbereitung bei 160 °C mit oder ohne Melting. Es können bis zu 100 Programme gespeichert werden. Anwesenheits- sowie maximaler Ölstandsensor. Heißölfilterpumpe max 180°C, Tankreinigung, Tankentleerung. Integrierte 2 Korbheber. Becken 18 lt. cm.31x34x33h - 2 Körbe cm.13,5x29x21h. Einlegesieb und Deckel für Becken. Ölauffangbecken mit Halterung auf Rädern und 5-Mikron-Filter (Stk.100 inbegriffen). Pommes frites: 23 kg/h (inbegriffen alle 2 Abschluss-Element)

FR FRITEUSE ÉLECTRIQUE ÉLECTRONIQUE à Écran tactile 7". Conservation à 110 °C ou Pré-traitement à 160 °C avec ou sans Melting. Possibilité d'enregistrer jusqu'à 100 programmes en mémoire. Capteur de présence et de niveau maximal huile. Pompe filtration huile à chaud max 180°C, nettoyage cuve, vidange cuve. 2 Élévateurs paniers intégrés. Cuve 18 lt. cm.31x34x33h - 2 Paniers cm.13,5x29x21h. Filtre, couvercle pour cuve. Bassine de collecte de l'huile avec support sur roues et filtre 5 microns (pcs.100 inclus). Production de pommes frites: 23 kg/h (inclus tous 2 Élément de jonction top)

ES FREIDORA ELÉCTRICA ELECTRÓNICA CON PANTALLA TÁCTIL DE 7". CONSERVACIÓN A 110 °C O TRABAJO PREVIO A 160 °C CON O SIN FUSIÓN. SE PUEDEN ALMACENAR HASTA 100 PROGRAMAS EN LA MEMORIA. SENSOR DE PRESENCIA Y NIVEL MÁXIMO DE ACEITE. BOMBA DE FILTRADO DE ACEITE CALIENTE, MÁXIMO 180 °C, LIMPIEZA DEL TANQUE, VACIADO DEL TANQUE. 2 ELEVADORES DE CESTA INTEGRADOS. CUBA DE 18 LITROS CM. 31X34X33H - 2 CESTAS CM.13,5X29X21H. FILTRO Y TAPA PARA CUBA. CUBETA DE RECOGIDA DE ACEITE CON SOPORTE SOBRE RUEDAS Y FILTRO DE 5 MICRONES (PZ.100 INCLUIDA). PROD. PATATAS: 23 KG/H (INCLUIDAS TODAS LAS 2 CHAPA DE CIERRE PARA TOP)

cm. 40 x 70,5 x 90h

cm. 43 x 77 x 122h / kg 83 / m³ 0,404

F2/18-78ETD

0815A830



FRIGGITRICE ELETTRICA ELETTRONICA CON TOUCHSCREEN 7". CONSERVAZIONE A 110 °C O PRELAVORO A 160 °C CON O SENZA MELTING. POSSIBILITÀ DI INSERIRE IN MEMORIA FINO A 100 PROGRAMMI. SENSORE PRESENZA E LIVELLO MASSIMO OLIO. 2 VASCHE 18 LITRI CM.31X34X33H - 4 CESTI CM.13,5X29X21H - FILTRI E COPERCHI VASCHE. 2 BACINELLE RACCOLTA OLIO CON SUPPORTO SU RUOTE. PRODUZIONE PATATE: 46 KG/H (INCLUDE ENTRAMBE LE TESTATE CHIUSURA PIANO)

⚡ 31,9 kW
400V~3N
50/60 Hz

€ 12.512,00

- EN** Electric electronic Fryer with a 7" TouchScreen. Conservation at 110 °C and preworking at 160 °C with or without Melting. Possibility to store in the memory up to 100 programs. Oil presence sensor and maximum level sensor. 2 bowls 18 lts cm.31x34x33h - 4 baskets cm.13,5x29x21h. 2 Sieve and lid for pan. 2 Oil collection basin with support on wheels. Production: 46 kg/h (included both Heads end filler strip)
- DE** ELEKTRONISCHE ELEKTRISCHE FRITEUSE mit TouchScreen 7". Aufbewahrung bei 110 °C oder Vorbearbeitung bei 160 °C mit oder ohne Melting. Es können bis zu 100 Programme gespeichert werden. Anwesenheits- sowie maximaler Ölstandsensor. 2 Becken 18 lt. cm.31x34x33h - 4 Körbe cm.13,5x29x21h. 2 Einlegesieb und Deckel für Becken. Ölauffangbecken mit Halterung auf Rädern. Pommes frites: 46 kg/h (inbegriffen alle 2 Abschluss-Element)
- FR** FRITEUSE ÉLECTRIQUE ÉLECTRONIQUE à Écran tactile 7". Conservation à 110 °C ou Pré-traitement à 160 °C avec ou sans Melting. Possibilité d'enregistrer jusqu'à 100 programmes en mémoire. Capteur de présence et de niveau maximal huile. 2 Cuves 18 lt. cm.31x34x33h - 4 Paniers cm.13,5x29x21h. 2 Filtre, couvercle pour cuve. 2 Bassine de collecte de l'huile avec support sur roues. Production de pommes frites: 46 kg/h (inclus tous 2 Élément de jonction top)
- ES** FREIDORA ELÉCTRICA ELECTRÓNICA CON PANTALLA TÁCTIL DE 7". CONSERVACIÓN A 110 °C O TRABAJO PREVIO A 160 °C CON O SIN FUSIÓN. SE PUEDEN ALMACENAR HASTA 100 PROGRAMAS EN LA MEMORIA. SENSOR DE PRESENCIA Y NIVEL MÁXIMO DE ACEITE. 2 CUBAS DE 18 LITROS CM. 31X34X33H - 4 CESTAS CM.13,5X29X21H. 2 FILTROS Y TAPAS PARA CUBA. 2 CUBETAS DE RECOGIDA DE ACEITE CON SOPORTE SOBRE RUEDAS. PROD. PATATAS: 46 KG/H (INCLUIDAS TODAS LAS 2 CHAPA DE CIERRE PARA TOP)

cm. 80 x 70,5 x 90h
 cm. 83 x 77 x 122h / kg 109 / m³ 0,780

F2/18-78ETDP

0815A831

FRIGGITRICE ELETTRICA ELETTRONICA CON TOUCHSCREEN 7". CONSERVAZIONE A 110 °C O PRELAVORO A 160 °C CON O SENZA MELTING. POSSIBILITÀ DI INSERIRE IN MEMORIA FINO A 100 PROGRAMMI. SENSORE PRESENZA E LIVELLO MASSIMO OLIO. 2 POMPE FILTRAGGIO OLIO A CALDO MAX 180°C, PULIZIA VASCA, SVUOTAMENTO VASCA. 2 VASCHE 18 LITRI CM.31X34X33H - 4 CESTI CM.13,5X29X21H - FILTRI E COPERCHI VASCHE. 2 BACINELLE RACCOLTA OLIO CON SUPPORTO SU RUOTE E FILTRO 5 MICRON (PZ.100 INCLUSI). PRODUZIONE PATATE: 46 KG/H (INCLUDE ENTRAMBE LE TESTATE CHIUSURA PIANO)

⚡ 32,4 kW
400V~3N
50/60 Hz

€ 19.207,00

- EN** Electric electronic Fryer with a 7" TouchScreen. Conservation at 110 °C and preworking at 160 °C with or without Melting. Possibility to store in the memory up to 100 programs. Oil presence sensor and maximum level sensor. 2 Pump for filter the hot oil max 180°C, Tank cleaning, Tank emptying. 2 bowls 18 lts cm.31x34x33h - 4 baskets cm.13,5x29x21h. 2 Sieve and lid for pan. 2 Oil collection basin with support on wheels with sieve 5 microns (pcs.100 included). Production: 46 kg/h (included both Heads end filler strip)
- DE** ELEKTRONISCHE ELEKTRISCHE FRITEUSE mit TouchScreen 7". Aufbewahrung bei 110 °C oder Vorbearbeitung bei 160 °C mit oder ohne Melting. Es können bis zu 100 Programme gespeichert werden. Anwesenheits- sowie maximaler Ölstandsensor. 2 Heißölfilterpumpe max 180°C, Tankreinigung, Tankentleerung. 2 Becken 18 lt. cm.31x34x33h - 4 Körbe cm.13,5x29x21h. 2 Einlegesieb und Deckel für Becken. 2 Ölauffangbecken mit Halterung auf Rädern und 5-Mikron-Filter (Stk.100 inbegriffen). Pommes frites: 46 kg/h (inbegriffen alle 2 Abschluss-Element)
- FR** FRITEUSE ÉLECTRIQUE ÉLECTRONIQUE à Écran tactile 7". Conservation à 110 °C ou Pré-traitement à 160 °C avec ou sans Melting. Possibilité d'enregistrer jusqu'à 100 programmes en mémoire. Capteur de présence et de niveau maximal huile. 2 Pompe filtration huile à chaud max 180°C, nettoyage cuve, vidange cuve. 2 Cuves 18 lt. cm.31x34x33h - 4 Paniers cm.13,5x29x21h. 2 Filtre, couvercle pour cuve. 2 Bassine de collecte de l'huile avec support sur roues et filtre 5 microns (pcs.100 inclus). Production de pommes frites: 46 kg/h (inclus tous 2 Élément de jonction top)
- ES** FREIDORA ELÉCTRICA ELECTRÓNICA CON PANTALLA TÁCTIL DE 7". CONSERVACIÓN A 110 °C O TRABAJO PREVIO A 160 °C CON O SIN FUSIÓN. SE PUEDEN ALMACENAR HASTA 100 PROGRAMAS EN LA MEMORIA. SENSOR DE PRESENCIA Y NIVEL MÁXIMO DE ACEITE. 2 BOMBA DE FILTRADO DE ACEITE CALIENTE, MÁXIMO 180 °C, LIMPIEZA DEL TANQUE, VACIADO DEL TANQUE. 2 CUBAS DE 18 LITROS CM. 31X34X33H - 4 CESTAS CM.13,5X29X21H. 2 FILTROS Y TAPAS PARA CUBA. 2 CUBETAS DE RECOGIDA DE ACEITE CON SOPORTE SOBRE RUEDAS Y FILTRO DE 5 MICRONES (PZ.100 INCLUIDA). PROD. PATATAS: 46 KG/H (INCLUIDAS TODAS LAS 2 CHAPA DE CIERRE PARA TOP)

cm. 80 x 70,5 x 90h
 cm. 83 x 77 x 122h / kg 129 / m³ 0,780

F2/18-78ETDPS

0815A832



FRIGGITRICE ELETTRICA ELETTRONICA CON TOUCHSCREEN 7". CONSERVAZIONE A 110 °C O PRELAVORO A 160 °C CON O SENZA MELTING. POSSIBILITÀ DI INSERIRE IN MEMORIA FINO A 100 PROGRAMMI. SENSORE PRESENZA E LIVELLO MASSIMO OLIO. 2 POMPE FILTRAGGIO OLIO A CALDO MAX 180°C, PULIZIA VASCA, SVUOTAMENTO VASCA. 4 SOLLEVATORI CESTI INTEGRATI. 2 VASCHE 18 LITRI CM.31X34X33H - 4 CESTI CM.13,5X29X21H - FILTRI E COPERCHI VASCHE. 2 BACINELLE RACCOLTA OLIO CON SUPPORTO SU RUOTE E FILTRO 5 MICRON (PZ.100 INCLUSI). PRODUZIONE PATATE: 46 KG/H (INCLUSE ENTRAMBE LE TESTATE CHIUSURA PIANO)

33,1 kW
400V~3N
50/60 Hz
€ 24.231,00

EN Electric electronic Fryer with a 7" TouchScreen. Conservation at 110 °C and preworking at 160 °C with or without Melting. Possibility to store in the memory up to 100 programs. Oil presence sensor and maximum level sensor. 2 Pump for filter the hot oil max 180°C, Tank cleaning, Tank emptying. 4 Lifter for baskets integrated. 2 bowls 18 lts cm.31x34x33h - 4 baskets cm.13,5x29x21h. 2 Sieve and lid for pan. 2 Oil collection basin with support on wheels with sieve 5 microns (pcs.100 included). Production: 46 kg/h (included both Heads end filler strip)

DE ELEKTRONISCHE ELEKTRISCHE FRITEUSE mit TouchScreen 7". Aufbewahrung bei 110 °C oder Vorbereitung bei 160 °C mit oder ohne Melting. Es können bis zu 100 Programme gespeichert werden. Anwesenheits- sowie maximaler Ölstandsensoren. 2 Heißölfilterpumpe max 180°C, Tankreinigung, Tankentleerung. Integrierte 4 Korbheber. 2 Becken 18 lt. cm.31x34x33h - 4 Körbe cm.13,5x29x21h. 2 Einlegesieb und Deckel für Becken. 2 Ölauffangbecken mit Halterung auf Rädern und 5-Mikron-Filter (Stk.100 inbegriffen). Pommes frites: 46 kg/h (inbegriffen alle 2 Abschluss-Element)

FR FRITEUSE ÉLECTRIQUE ÉLECTRONIQUE à Écran tactile 7". Conservation à 110 °C ou Pré-traitement à 160 °C avec ou sans Melting. Possibilité d'enregistrer jusqu'à 100 programmes en mémoire. Capteur de présence et de niveau maximal huile. 2 Pompe filtration huile à chaud max 180°C, nettoyage cuve, vidange cuve. 4 Élévateurs paniers intégrés. 2 Cuve 18 lt. cm.31x34x33h - 4 Paniers cm.13,5x29x21h. 2 Filtre, couvercle pour cuve. 2 Bassine de collecte de l'huile avec support sur roues et filtre 5 microns (pcs.100 inclus). Production de pommes frites: 46 kg/h (inclus tous 2 Élément de jonction top)

ES FREIDORA ELÉCTRICA ELECTRÓNICA CON PANTALLA TÁCTIL DE 7". CONSERVACIÓN A 110 °C O TRABAJO PREVIO A 160 °C CON O SIN FUSIÓN. SE PUEDEN ALMACENAR HASTA 100 PROGRAMAS EN LA MEMORIA. SENSOR DE PRESENCIA Y NIVEL MÁXIMO DE ACEITE. 2 BOMBA DE FILTRADO DE ACEITE CALIENTE, MÁXIMO 180 °C, LIMPIEZA DEL TANQUE, VACIADO DEL TANQUE. 4 ELEVADORES DE CESTA INTEGRADOS. 2 CUBAS DE 18 LITROS CM. 31X34X33H - 4 CESTAS CM.13,5X29X21H. 2 FILTROS Y TAPAS PARA CUBA. 2 CUBETAS DE RECOGIDA DE ACEITE CON SOPORTE SOBRE RUEDAS Y FILTRO DE 5 MICRONES (PZ.100 INCLUIDA). PROD. PATATAS: 46 KG/H (INCLUIDAS TODAS LAS 2 CHAPA DE CIERRE PARA TOP)

cm. 80 x 70,5 x 90h

cm. 83 x 77 x 122h / kg 149 / m³ 0,780

FRIGGITRICI A GAS DIGITALI

EN GAS ELECTRONIC FRYERS DE ELEKTRONISCHE GAS-FRITEUSE FR FRITEUSE À GAZ ÉLECTRONIQUE ES FREIDORAS A GAS ELECTRÓNICA

F18-74GD

0832A450



FRIGGITRICE GAS "PREMIX" ELETTRONICA CON TOUCHSCREEN 7". CONSERVAZIONE A 110 °C O PRELAVORO A 160 °C CON O SENZA MELTING. POSSIBILITÀ DI INSERIRE IN MEMORIA FINO A 100 PROGRAMMI. SENSORE PRESENZA E LIVELLO MASSIMO OLIO. VASCA 18 LITRI CM.31X34X42H CON BRUCIATORI ESTERNI. 2 CESTI CM.13X28X15H - FILTRO E COPERCHIO VASCA. BACINELLA RACCOLTA OLIO CON SUPPORTO SU RUOTE. PRODUZIONE PATATE: 22 KG/H (INCLUDE ENTRAMBE LE TESTATE CHIUSURA PIANO)

EN Gas "PREMIX" electronic Fryer with a 7" TouchScreen. Conservation at 110 °C and preworking at 160 °C with or without Melting. Possibility to store in the memory up to 100 programs. Oil presence sensor and maximum level sensor. Bowl 18 lts cm.31x34x42h with external burners. 2 baskets cm.13x28x15h. Sieve and lid for pan. Oil collection basin with support on wheels. Production: 22 kg/h (included both Heads end filler strip)

DE ELEKTRONISCHE GAS "PREMIX" FRITEUSE mit TouchScreen 7". Aufbewahrung bei 110 °C oder Vorbearbeitung bei 160 °C mit oder ohne Melting. Es können bis zu 100 Programme gespeichert werden. Anwesenheits- sowie maximaler Ölstandsensoren. Becken 18 lt. cm.31x34x42h mit externe Brenner. 2 Körbe cm.13x28x15h. Einlegesieb und Deckel für Becken. Ölauffangbecken mit Halterung auf Rädern. Pommes frites: 22 kg/h(inbegriffen alle 2 Abschluss-Element)

FR FRITEUSE GAZ "PREMIX" ÉLECTRONIQUE à Écran tactile 7". Conservation à 110 °C ou Pré-traitement à 160 °C avec ou sans Melting. Possibilité d'enregistrer jusqu'à 100 programmes en mémoire. Capteur de présence et de niveau maximal huile. Cuve 18 lt. cm.31x34x42h avec brûleurs externes. 2 Paniers cm.13x28x15h. Filtre, couvercle pour cuve. Bassine de collecte de l'huile avec support sur roues. Production de pommes frites: 22 kg/h (inclus tous 2 Élément de jonction top)

ES FREIDORA GAS "PREMIX" ELECTRÓNICA CON PANTALLA TÁCTIL DE 7". CONSERVACIÓN A 110 °C O TRABAJO PREVIO A 160 °C CON O SIN FUSIÓN. SE PUEDEN ALMACENAR HASTA 100 PROGRAMAS EN LA MEMORIA. SENSOR DE PRESENCIA Y NIVEL MÁXIMO DE ACEITE. CUBA DE 18 LITROS CM. 31X34X42H CON QUEMADORES EXTERNOS. 2 CESTAS CM.13X28X15H. FILTRO Y TAPA PARA CUBA. CUBETA DE RECOGIDA DE ACEITE CON SOPORTE SOBRE RUEDAS. PROD. PATATAS: 22 KG/H (INCLUIDAS TODAS LAS 2 CHAPA DE CIERRE PARA TOP)

cm. 40 x 70,5 x 90h

cm. 43 x 77 x 122h / kg 72 / m³ 0,404

18 kW
15.480 kcal/h

€ 9.129,00

0,05 kW
230V~
50 Hz

F18-74GDP

0832A451

FRIGGITRICE GAS "PREMIX" ELETTRONICA CON TOUCHSCREEN 7". CONSERVAZIONE A 110 °C O PRELAVORO A 160 °C CON O SENZA MELTING. POSSIBILITÀ DI INSERIRE IN MEMORIA FINO A 100 PROGRAMMI. SENSORE PRESENZA E LIVELLO MASSIMO OLIO. POMPA FILTRAGGIO OLIO A CALDO MAX 180°C, PULIZIA VASCA, SVUOTAMENTO VASCA. VASCA 18 LITRI CM.31X34X42H CON BRUCIATORI ESTERNI. 2 CESTI CM.13X28X15H. FILTRO E COPERCHIO VASCA. BACINELLA RACCOLTA OLIO CON SUPPORTO SU RUOTE E FILTRO 5 MICRON (PZ.100 INCLUSI). PRODUZIONE PATATE: 22 KG/H (INCLUDE ENTRAMBE LE TESTATE CHIUSURA PIANO)

EN Gas "PREMIX" electronic Fryer with a 7" TouchScreen. Conservation at 110 °C and preworking at 160 °C with or without Melting. Possibility to store in the memory up to 100 programs. Oil presence sensor and maximum level sensor. Pump for filter the hot oil max 180°C, Tank cleaning, Tank emptying. Bowl 18 lts cm.31x34x42h with external burners. 2 baskets cm.13x28x15h. Sieve and lid for pan. Oil collection basin with support on wheels with sieve 5 microns (pcs.100 included). Production: 22 kg/h (included both Heads end filler strip)

DE ELEKTRONISCHE GAS "PREMIX" FRITEUSE mit TouchScreen 7". Aufbewahrung bei 110 °C oder Vorbearbeitung bei 160 °C mit oder ohne Melting. Es können bis zu 100 Programme gespeichert werden. Anwesenheits- sowie maximaler Ölstandsensoren. Heißölfilterpumpe max 180°C, Tankreinigung, Tankentleerung. Becken 18 lt. cm.31x34x42h mit externe Brenner. 2 Körbe cm.13x28x15h. Einlegesieb und Deckel für Becken. Ölauffangbecken mit Halterung auf Rädern und 5-Mikron-Filter (Stk.100 inbegriffen). Pommes frites: 22 kg/h(inbegriffen alle 2 Abschluss-Element)

FR FRITEUSE GAZ "PREMIX" ÉLECTRONIQUE à Écran tactile 7". Conservation à 110 °C ou Pré-traitement à 160 °C avec ou sans Melting. Possibilité d'enregistrer jusqu'à 100 programmes en mémoire. Capteur de présence et de niveau maximal huile. Pompe filtration huile à chaud max 180°C, nettoyage cuve, vidange cuve. Cuve 18 lt. cm.31x34x42h avec brûleurs externes. 2 Paniers cm.13x28x15h. Filtre, couvercle pour cuve. Bassine de collecte de l'huile avec support sur roues et filtre 5 microns (pcs.100 inclus). Production de pommes frites: 22 kg/h (inclus tous 2 Élément de jonction top)

ES FREIDORA GAS "PREMIX" ELECTRÓNICA CON PANTALLA TÁCTIL DE 7". CONSERVACIÓN A 110 °C O TRABAJO PREVIO A 160 °C CON O SIN FUSIÓN. SE PUEDEN ALMACENAR HASTA 100 PROGRAMAS EN LA MEMORIA. SENSOR DE PRESENCIA Y NIVEL MÁXIMO DE ACEITE. BOMBA DE FILTRADO DE ACEITE CALIENTE, MÁXIMO 180 °C, LIMPIEZA DEL TANQUE, VACIADO DEL TANQUE. CUBA DE 18 LITROS CM. 31X34X42H CON QUEMADORES EXTERNOS. 2 CESTAS CM.13X28X15H. FILTRO Y TAPA PARA CUBA. CUBETA DE RECOGIDA DE ACEITE CON SOPORTE SOBRE RUEDAS Y FILTRO DE 5 MICRONES (PZ.100 INCLUIDA). PROD. PATATAS: 22 KG/H (INCLUIDAS TODAS LAS 2 CHAPA DE CIERRE PARA TOP)

cm. 40 x 70,5 x 90h

cm. 43 x 77 x 122h / kg 82 / m³ 0,404

18 kW
15.480 kcal/h

€ 12.442,00

0,3 kW
230V~
50 Hz

F18-74GDPS

0832A452



FRIGGITRICE GAS "PREMIX" ELETTRONICA CON TOUCHSCREEN 7". CONSERVAZIONE A 110 °C O PRELAVORO A 160 °C CON O SENZA MELTING. POSSIBILITÀ DI INSERIRE IN MEMORIA FINO A 100 PROGRAMMI. SENSORE PRESENZA E LIVELLO MASSIMO OLIO. POMPA FILTRAGGIO OLIO A CALDO MAX 180°C, PULIZIA VASCA, SVUOTAMENTO VASCA. 2 SOLLEVATORI CESTI INTEGRATI. VASCA 18 LITRI CM.31X34X42H CON BRUCIATORI ESTERNI. 2 CESTI CM.13X28X15H. FILTRO E COPERCHIO VASCA. BACINELLA RACCOLTA OLIO CON SUPPORTO SU RUOTE E FILTRO 5 MICRON (PZ.100 INCLUSI). PRODUZIONE PATATE: 22 KG/H (INCLUSE ENTRAMBE LE TESTATE CHIUSURA PIANO)

EN Gas "PREMIX" electronic Fryer with a 7" TouchScreen. Conservation at 110 °C and preworking at 160 °C with or without Melting. Possibility to store in the memory up to 100 programs. Oil presence sensor and maximum level sensor. Pump for filter the hot oil max 180°C, Tank cleaning, Tank emptying. 2 Lifter for baskets integrated. Bowl 18 lts cm.31x34x42h with external burners. 2 baskets cm.13x28x15h. Sieve and lid for pan. Oil collection basin with support on wheels with sieve 5 microns (pcs.100 included). Production: 22 kg/h (included both Heads end filler strip)

DE ELEKTRONISCHE GAS "PREMIX" FRITEUSE mit TouchScreen 7". Aufbewahrung bei 110 °C oder Vorbereitung bei 160 °C mit oder ohne Melting. Es können bis zu 100 Programme gespeichert werden. Anwesenheits- sowie maximaler Ölstandsensoren. Heißölfilterpumpe max 180°C, Tankreinigung, Tankentleerung. Integrierte 2 Korbheber. Becken 18 lt. cm.31x34x42h mit externe Brenner. 2 Körbe cm.13x28x15h. Einlegesieb und Deckel für Becken. Ölauffangbecken mit Halterung auf Rädern und 5-Mikron-Filter (Stk.100 inbegriffen). Pommes frites: 22 kg/h(inbegriffen alle 2 Abschluss-Element)

FR FRITEUSE GAZ "PREMIX" ÉLECTRONIQUE à Écran tactile 7". Conservation à 110 °C ou Pré-traitement à 160 °C avec ou sans Melting. Possibilité d'enregistrer jusqu'à 100 programmes en mémoire. Capteur de présence et de niveau maximal huile. Pompe filtration huile à chaud max 180°C, nettoyage cuve, vidange cuve. 2 Élévateurs paniers intégrés. Cuve 18 lt. cm.31x34x42h avec bruleurs externes. 2 Paniers cm.13x28x15h. Filtre, couvercle pour cuve. Bassine de collecte de l'huile avec support sur roues et filtre 5 microns (pcs.100 inclus). Production de pommes frites: 22 kg/h (inclus tous 2 Élément de jonction top)

ES FREIDORA GAS "PREMIX" ELECTRÓNICA CON PANTALLA TÁCTIL DE 7". CONSERVACIÓN A 110 °C O TRABAJO PREVIO A 160 °C CON O SIN FUSIÓN. SE PUEDEN ALMACENAR HASTA 100 PROGRAMAS EN LA MEMORIA. SENSOR DE PRESENCIA Y NIVEL MÁXIMO DE ACEITE. BOMBA DE FILTRADO DE ACEITE CALIENTE, MÁXIMO 180 °C, LIMPIEZA DEL TANQUE, VACIADO DEL TANQUE. 2 ELEVADORES DE CESTA INTEGRADOS. CUBA DE 18 LITROS CM. 31X34X42H CON QUEMADORES EXTERNOS. 2 CESTAS CM.13X28X15H. FILTRO Y TAPA PARA CUBA. CUBETA DE RECOGIDA DE ACEITE CON SOPORTE SOBRE RUEDAS Y FILTRO DE 5 MICRONES (PZ.100 INCLUIDA). PROD. PATATAS: 22 KG/H (INCLUIDAS TODAS LAS 2 CHAPA DE CIERRE PARA TOP)

cm. 40 x 70,5 x 90h

cm. 43 x 77 x 122h / kg 92 / m³ 0,404

18 kW € 14.342,00
15.480 kcal/h

0,65 kW
230V~
50 Hz

F2/18-78GD

0832A850



FRIGGITRICE GAS "PREMIX" ELETTRONICA CON TOUCHSCREEN 7". CONSERVAZIONE A 110 °C O PRELAVORO A 160 °C CON O SENZA MELTING. POSSIBILITÀ DI INSERIRE IN MEMORIA FINO A 100 PROGRAMMI. SENSORE PRESENZA E LIVELLO MASSIMO OLIO. 2 VASCHE 18 LITRI CM.31X34X42H CON BRUCIATORI ESTERNI. 4 CESTI CM.13X28X15H. FILTRI E COPERCHI VASCHE. 2 BACINELLE RACCOLTA OLIO CON SUPPORTO SU RUOTE. PRODUZIONE PATATE: 44 KG/H (INCLUDE ENTRAMBE LE TESTATE CHIUSURA PIANO)

EN Gas "PREMIX" electronic Fryer with a 7" TouchScreen. Conservation at 110 °C and preworking at 160 °C with or without Melting. Possibility to store in the memory up to 100 programs. Oil presence sensor and maximum level sensor. 2 bowls 18 lts cm.31x34x42h with external burners. 4 baskets cm.13x28x15h. 2 Sieve and lid for pan. 2 Oil collection basin with support on wheels. Production: 44 kg/h (included both Heads end filler strip)

DE ELEKTRONISCHE GAS "PREMIX" FRITEUSE mit TouchScreen 7". Aufbewahrung bei 110 °C oder Vorbearbeitung bei 160 °C mit oder ohne Melting. Es können bis zu 100 Programme gespeichert werden. Anwesenheits- sowie maximaler Ölstandsensor. 2 Becken 18 lt. cm.31x34x42h mit externe Brenner. 4 Körbe cm.13x28x15h. 2 Einlegesieb und Deckel für Becken. Ölauffangbecken mit Halterung auf Rädern. Pommes frites: 44 kg/h(inbegriffen alle 2 Abschluss-Element)

FR FRITEUSE GAZ "PREMIX" ÉLECTRONIQUE à Écran tactile 7". Conservation à 110 °C ou Pré-traitement à 160 °C avec ou sans Melting. Possibilité d'enregistrer jusqu'à 100 programmes en mémoire. Capteur de présence et de niveau maximal huile. 2 Cuves 18 lt. cm.31x34x42h avec bruleurs externes. 4 Paniers cm.13x28x15h. 2 Filtre, couvercle pour cuve. 2 Bassine de collecte de l'huile avec support sur roues. Production de pommes frites: 44 kg/h (inclus tous 2 Élément de jonction top)

ES FREIDORA GAS "PREMIX" ELECTRÓNICA CON PANTALLA TÁCTIL DE 7". CONSERVACIÓN A 110 °C O TRABAJO PREVIO A 160 °C CON O SIN FUSIÓN. SE PUEDEN ALMACENAR HASTA 100 PROGRAMAS EN LA MEMORIA. SENSOR DE PRESENCIA Y NIVEL MÁXIMO DE ACEITE. 2 CUBAS DE 18 LITROS CM. 31X34X42H CON QUEMADORES EXTERNOS. 4 CESTAS CM.13X28X15H. 2 FILTROS Y TAPAS PARA CUBA. 2 CUBETAS DE RECOGIDA DE ACEITE CON SOPORTE SOBRE RUEDAS. PROD. PATATAS: 44 KG/H (INCLUIDAS TODAS LAS 2 CHAPA DE CIERRE PARA TOP)

cm. 80 x 70,5 x 90h

cm. 83 x 77 x 122h / kg 123 / m³ 0,780

36 kW € 17.514,00
30.960 kcal/h

0,1 kW
230V~
50 Hz

F2/18-78GDP

0832A851

FRIGGITRICE GAS "PREMIX" ELETTRONICA CON TOUCHSCREEN 7". CONSERVAZIONE A 110 °C O PRELAVORO A 160 °C CON O SENZA MELTING. POSSIBILITÀ DI INSERIRE IN MEMORIA FINO A 100 PROGRAMMI. SENSORE PRESENZA E LIVELLO MASSIMO OLIO. 2 POMPE FILTRAGGIO OLIO A CALDO MAX 180°C, PULIZIA VASCA, SVUOTAMENTO VASCA. 2 VASCHE 18 LITRI CM.31X34X42H CON BRUCIATORI ESTERNI. 4 CESTI CM.13X28X15H. FILTRI E COPERCHI VASCHE. 2 BACINELLE RACCOLTA OLIO CON SUPPORTO SU RUOTE E FILTRO 5 MICRON (PZ.100 INCLUSI). PRODUZIONE PATATE: 44 KG/H (INCLUDE ENTRAMBE LE TESTATE CHIUSURA PIANO)

EN Gas "PREMIX" electronic Fryer with a 7" TouchScreen. Conservation at 110 °C and preworking at 160 °C with or without Melting. Possibility to store in the memory up to 100 programs. Oil presence sensor and maximum level sensor. 2 Pump for filter the hot oil max 180°C, Tank cleaning, Tank emptying. 2 bowls 18 lts cm.31x34x42h with external burners. 4 baskets cm.13x28x15h. 2 Sieve and lid for pan. 2 Oil collection basin with support on wheels with sieve 5 microns (pcs.100 included). Production: 44 kg/h (included both Heads end filler strip)

DE ELEKTRONISCHE GAS "PREMIX" FRITEUSE mit TouchScreen 7". Aufbewahrung bei 110 °C oder Vorbearbeitung bei 160 °C mit oder ohne Melting. Es können bis zu 100 Programme gespeichert werden. Anwesenheits- sowie maximaler Ölstandsensor. 2 Heißölfilterpumpe max 180°C, Tankreinigung, Tankentleerung. 2 Becken 18 lt. cm.31x34x42h mit externe Brenner. 4 Körbe cm.13x28x15h. 2 Einlegesieb und Deckel für Becken. 2 Ölauffangbecken mit Halterung auf Rädern und 5-Mikron-Filter (Stk.100 inbegriffen). Pommes frites: 44 kg/h(inbegriffen alle 2 Abschluss-Element)

FR FRITEUSE GAZ "PREMIX" ÉLECTRONIQUE à Écran tactile 7". Conservation à 110 °C ou Pré-traitement à 160 °C avec ou sans Melting. Possibilité d'enregistrer jusqu'à 100 programmes en mémoire. Capteur de présence et de niveau maximal huile. 2 Pompe filtration huile à chaud max 180°C, nettoyage cuve, vidange cuve. 2 Cuves 18 lt. cm.31x34x42h avec bruleurs externes. 4 Paniers cm.13x28x15h. 2 Filtre, couvercle pour cuve. 2 Bassine de collecte de l'huile avec support sur roues et filtre 5 microns (pcs.100 inclus). Production de pommes frites: 44 kg/h (inclus tous 2 Élément de jonction top)

ES FREIDORA GAS "PREMIX" ELECTRÓNICA CON PANTALLA TÁCTIL DE 7". CONSERVACIÓN A 110 °C O TRABAJO PREVIO A 160 °C CON O SIN FUSIÓN. SE PUEDEN ALMACENAR HASTA 100 PROGRAMAS EN LA MEMORIA. SENSOR DE PRESENCIA Y NIVEL MÁXIMO DE ACEITE. 2 BOMBA DE FILTRADO DE ACEITE CALIENTE, MÁXIMO 180 °C, LIMPIEZA DEL TANQUE, VACIADO DEL TANQUE. 2 CUBAS DE 18 LITROS CM. 31X34X42H CON QUEMADORES EXTERNOS. 4 CESTAS CM.13X28X15H. 2 FILTROS Y TAPAS PARA CUBA. 2 CUBETAS DE RECOGIDA DE ACEITE CON SOPORTE SOBRE RUEDAS Y FILTRO DE 5 MICRONES (PZ.100 INCLUIDA). PROD. PATATAS: 44 KG/H (INCLUIDAS TODAS LAS 2 CHAPA DE CIERRE PARA TOP)

cm. 80 x 70,5 x 90h

cm. 83 x 77 x 122h / kg 143 / m³ 0,780

36 kW € 22.786,00
30.960 kcal/h

0,6 kW
230V~
50 Hz

F2/18-78GDPS

0832A852



FRIGGITRICE GAS "PREMIX" ELETTRONICA CON TOUCHSCREEN 7". CONSERVAZIONE A 110 °C O PRELAVORO A 160 °C CON O SENZA MELTING. POSSIBILITÀ DI INSERIRE IN MEMORIA FINO A 100 PROGRAMMI. SENSORE PRESENZA E LIVELLO MASSIMO OLIO. 2 POMPE FILTRAGGIO OLIO A CALDO MAX 180°C, PULIZIA VASCA, SVUOTAMENTO VASCA. 4 SOLLEVATORI CESTI INTEGRATI. 2 VASCHE 18 LITRI CM.31X34X42H CON BRUCIATORI ESTERNI. 4 CESTI CM.13X28X15H. FILTRI E COPERCHI VASCHE. 2 BACINELLE RACCOLTA OLIO CON SUPPORTO SU RUOTE E FILTRO 5 MICRON (PZ.100 INCLUSI). PRODUZIONE PATATE: 44 KG/H (INCLUSE ENTRAMBE LE TESTATE CHIUSURA PIANO)

36 kW
30.960 kcal/h

€ 27.762,00

1,3 kW
230V~
50 Hz

EN Gas "PREMIX" electronic Fryer with a 7" TouchScreen. Conservation at 110 °C and preworking at 160 °C with or without Melting. Possibility to store in the memory up to 100 programs. Oil presence sensor and maximum level sensor. 2 Pump for filter the hot oil max 180°C, Tank cleaning, Tank emptying. 4 Lifter for baskets integrated. 2 bowls 18 lts cm.31x34x42h with external burners. 4 baskets cm.13x28x15h. 2 Sieve and lid for pan. 2 Oil collection basin with support on wheels with sieve 5 microns (pcs.100 included). Production: 44 kg/h (included both Heads end filler strip)







DE ELEKTRONISCHE GAS "PREMIX" FRITEUSE mit TouchScreen 7". Aufbewahrung bei 110 °C oder Vorbearbeitung bei 160 °C mit oder ohne Melting. Es können bis zu 100 Programme gespeichert werden. Anwesenheits- sowie maximaler Ölstandsensor. 2 Heißölfilterpumpe max 180°C, Tankreinigung, Tankentleerung. Integrierte 4 Korbheber. 2 Becken 18 lt. cm.31x34x42h mit externe Brenner. 4 Körbe cm.13x28x15h. 2 Einlegesieb und Deckel für Becken. 2 Ölauffangbecken mit Halterung auf Rädern und 5-Mikron-Filter (Stk.100 inbegriffen). Pommes frites: 44 kg/h(inbegriffen alle 2 Abschluss-Element)

FR FRITEUSE GAZ "PREMIX" ÉLECTRONIQUE à Écran tactile 7". Conservation à 110 °C ou Pré-traitement à 160 °C avec ou sans Melting. Possibilité d'enregistrer jusqu'à 100 programmes en mémoire. Capteur de présence et de niveau maximal huile. 2 Pompe filtration huile à chaud max 180°C, nettoyage cuve, vidange cuve. 4 Élévateurs paniers intégrés. 2 Cuve 18 lt. cm.31x34x42h avec bruleurs externes. 4 Paniers cm.13x28x15h. 2 Filtre, couvercle pour cuve. 2 Bassine de collecte de l'huile avec support sur roues et filtre 5 microns (pcs.100 inclus). Production de pommes frites: 44 kg/h (inclus tous 2 Élément de jonction top)

ES FREIDORA GAS "PREMIX" ELECTRÓNICA CON PANTALLA TÁCTIL DE 7". CONSERVACIÓN A 110 °C O TRABAJO PREVIO A 160 °C CON O SIN FUSIÓN. SE PUEDEN ALMACENAR HASTA 100 PROGRAMAS EN LA MEMORIA. SENSOR DE PRESENCIA Y NIVEL MÁXIMO DE ACEITE. 2 BOMBA DE FILTRADO DE ACEITE CALIENTE, MÁXIMO 180 °C, LIMPIEZA DEL TANQUE, VACIADO DEL TANQUE. 4 ELEVADORES DE CESTA INTEGRADOS. 2 CUBAS DE 18 LITROS CM. 31X34X42H CON QUEMADORES EXTERNOS. 4 CESTAS CM.13X28X15H. 2 FILTROS Y TAPAS PARA CUBA. 2 CUBETAS DE RECOGIDA DE ACEITE CON SOPORTE SOBRE RUEDAS Y FILTRO DE 5 MICRONES (PZ.100 INCLUIDA). PROD. PATATAS: 44 KG/H (INCLUIDAS TODAS LAS 2 CHAPA DE CIERRE PARA TOP)

cm. 80 x 70,5 x 90h

cm. 83 x 77 x 122h / kg 163 / m³ 0,780

	ATTENZIONE!	IT - Una volta acceso l'apparecchio, l'installatore deve procedere alla regolazione del CO2 (massimo/minimo). Questa tipologia di operazione/taratura deve essere effettuata attraverso un misuratore di combustione.
	CAUTION!	EN - Once the appliance has been switched on, the installer must set the CO2 values (maximum/minimum). This type of operation/calibration must be carried out using a combustion meter.
	ACHTUNG!	DE - Nach dem Einschalten des Geräts muss der Installateur die Einstellung des CO2-Gehalts (maximal/minimal) vornehmen. Dieser Vorgang/diese Kalibrierung müssen mit einem Verbrennungsmessgerät durchgeführt werden.
	ATTENTION!	FR - Une fois l'appareil allumé, l'installateur doit procéder au réglage du CO2 (maximum/minimum). Ce type d'opération/étalonnage doit être effectué à l'aide d'un compteur de combustion.
	ATENCIÓN!	ES - Una vez encendido el aparato, el instalador debe proceder a la regulación del CO2 (máximo/mínimo). Este tipo de operación/calibración debe realizarse mediante un medidor de combustión.
	POZOR!	CZ - Po zapnutí spotřebiče musí instalační technik provést nastavení CO2 (maximum/minimum). Tento typ operace/kalibrace musí být proveden pomocí analyzátoru spalování.
	UWAGA!	PL - Po włączeniu urządzenia instalator musi przystąpić do regulacji CO2 (maksimum/minimum). Tego typu operacja/kalibracja musi być przeprowadzona za pomocą miernika spalania.

5630064A0M00P00.docx

BRASIERE FISSE MULTIFUNZIONE ELETTRICHE
EN FIXED ELECTRIC BRATT PANS **DE** ELEKTRO MULTIFUNKTIONSBRATPFANNE FEST **FR** SAUTEUSE FIXE ELÉCTRIQUE **ES** SARTEN FIJA ELECTRICA

BRF-74ET
08070433

BRASIERA FISSA MULTIFUNZIONALE ELETTRICA VASCA CM. 32,5X46X10H (INCLUSA 1 TESTATA CHIUSURA PIANO MOD.TPA-7)

EN Electric multi-function fixed braising pan - Bowl cm. 32,5x46x10h (included 1 Head end filler strip mod.TPA-7)

DE Elektrische Multifunktionsbratpfanne Fest Becken cm. 32,5x46x10h (inbegriffen 1 Abschluss-Element mod.TPA-7)

FR Sauteuse fixe multifonction électrique - Cuve cm. 32,5x46x10h (inclus 1 Élément de jonction top mod.TPA-7)

ES SARTEN FIJA MULTIFUNCIÓN ELÉCTRICA - CUBA CM. 32,5X46X10H (INCLUIDA 1 CHAPA DE CIERRE PARA TOP MOD.TPA-7)

cm. 40 x 70,5 x 90h

 cm. 43 x 77 x 111h / kg 79 / m³ 0,368

4,5 kW
400V~3N
230V~3
50/60 Hz

€ 4.201,00
BRF-78ET
08070833

BRASIERA FISSA MULTIFUNZIONALE ELETTRICA VASCA CM. 72,5X46X10H - 2 ZONE DI COTTURA (INCLUSA 1 TESTATA CHIUSURA PIANO MOD.TPA-7)

EN Electric multi-function fixed braising pan - Bowl cm. 72,5x46x10h - 2 cooking areas (included 1 Head end filler strip mod.TPA-7)

DE Elektrische Multifunktionsbratpfanne Fest Becken cm. 72,5x46x10h - 2 Heizzonen (inbegriffen 1 Abschluss-Element mod.TPA-7)

FR Sauteuse fixe multifonction électrique - Cuve cm. 72,5x46x10h - 2 zones de cuisson (inclus 1 Élément de jonction top mod.TPA-7)

ES SARTEN FIJA MULTIFUNCIÓN ELÉCTRICA - CUBA CM. 72,5X46X10H - 2 ZONAS DE COCCIÓN (INCLUIDA 1 CHAPA DE CIERRE PARA TOP MOD. TPA-7)

cm. 80 x 70,5 x 90h

 cm. 83 x 77 x 111h / kg 126 / m³ 0,709

9 kW
400V~3N
230V~3
50/60 Hz

€ 6.763,00
BRASIERE FISSE MULTIFUNZIONE A GAS
EN FIXED GAS BRATT PANS **DE** GAS MULTIFUNKTIONSBRATPFANNE FEST **FR** SAUTEUSE FIXE A GAZ **ES** SARTEN FIJA DE GAS

BRF-74G
08240453

BRASIERA FISSA MULTIFUNZIONALE GAS VASCA 30X51X10H (INCLUSA 1 TESTATA CHIUSURA PIANO MOD.TPA-7)

EN Gas multi-function fixed braising pan Bowl 30x51x10h (included 1 Head end filler strip mod.TPA-7)

DE Gas-Multifunktionsbratpfanne Fest Becken 30x51x10h (inbegriffen 1 Abschluss-Element mod.TPA-7)

FR Sauteuse fixe multifonction à gaz - Cuve 30x51x10h (inclus 1 Élément de jonction top mod.TPA-7)

ES SARTEN FIJA MULTIFUNCIÓN A GAS - CUBA 30X51X10H (INCLUIDA 1 CHAPA DE CIERRE PARA TOP MOD.TPA-7)

cm. 40 x 70,5 x 90h

 cm. 43 x 77 x 111h / kg 79 / m³ 0,368

6,95 kW
5.970 kcal/h

€ 4.406,00
BRF-78G
08240853

BRASIERA FISSA MULTIFUNZIONALE GAS VASCA 70X51X10H (INCLUSA 1 TESTATA CHIUSURA PIANO MOD.TPA-7)

EN Gas multi-function fixed braising pan Bowl 70x51x10h (included 1 Head end filler strip mod.TPA-7)

DE Gas-Multifunktionsbratpfanne Fest Becken 70x51x10h (inbegriffen 1 Abschluss-Element mod.TPA-7)

FR Sauteuse fixe multifonction à gaz - Cuve 70x51x10h (inclus 1 Élément de jonction top mod.TPA-7)

ES SARTEN FIJA MULTIFUNCIÓN A GAS - CUBA 70X51X10H (INCLUIDA 1 CHAPA DE CIERRE PARA TOP MOD.TPA-7)

cm. 80 x 70,5 x 90h

 cm. 83 x 77 x 111h / kg 129 / m³ 0,709

13,9 kW
11.940 kcal/h

€ 6.783,00

BRASIERE RIBALTABILI ELETTRICHE

EN ELECTRIC TILTING BRATTPANS DE ELEKTRO KIPPEN BRATPFANNEN FR SAUTESE BASCULANTE ÉLECTRIQUE ES SARTEN BASCULANTES ELECTRICO

BR50-78ET

08130830



BRASIERA A RIBALTAMENTO MANUALE, VASCA INOX 50 LITRI CM.71X37X18,5H, COPERCHIO DOPPIA PARETE

EN Braising pan with manual tilting, inox bowl 50 lt. cm.71x37x18,5h, double wall lid
DE Kippbratpfanne mit manual Kippung, Edelstahlschale 50 Lt. cm.71x37x18,5h, Doppelwanddeckel

FR Sauteuse avec basculement manuel, cuve inox 50 lt. cm.71x37x18,5h, couvercle à double paroi

ES SARTÉN CON LEVANTAMIENTO MANUAL, CUBA DE ACERO INOX 50 LT. CM.71X37X18,5HH, TAPA DE DOBLE PARED

cm. 80 x 70,5 x 90h

cm. 83 x 77 x 111h / kg 133 / m³ 0,709

10,5 kW
400V~3N
50/60 Hz

€ 6.736,00

BRM50-78ET

08130831



BRASIERA A RIBALTAMENTO AUTOMATICO, VASCA INOX 50 LITRI CM.71X37X18,5H, COPERCHIO DOPPIA PARETE

EN Braising pan with automatic tilting, inox bowl 50 lt. cm.71x37x18,5h, double wall lid
DE Kippbratpfanne mit automatisch Kippung, Edelstahlschale 50 Lt. cm.71x37x18,5h, Doppelwanddeckel

FR Sauteuse avec basculement automatique, cuve inox 50 lt. cm.71x37x18,5h, couvercle à double paroi

ES SARTÉN CON LEVANTAMIENTO AUTOMATICO, CUBA DE ACERO INOX 50 LT. CM.71X37X18,5HH, TAPA DE DOBLE PARED

cm. 80 x 70,5 x 90h

cm. 83 x 77 x 111h / kg 135 / m³ 0,709

10,5 kW
400V~3N
50/60 Hz

€ 7.861,00

BRASIERE RIBALTABILI A GAS

EN GAS TILTING BRATTPANS DE GAS KIPPEN BRATPFANNEN FR SAUTESE BASCULANTE A GAZ ES SARTEN BASCULANTES DE GAS

BR50-78G

08340850



BRASIERA A RIBALTAMENTO MANUALE, VASCA INOX 50 LITRI CM.71X37X18,5H, COPERCHIO DOPPIA PARETE

EN Braising pan with manual tilting, inox bowl 50 lt. cm.71x37x18,5h, double wall lid
DE Kippbratpfanne mit manual Kippung, Edelstahlschale 50 Lt. cm.71x37x18,5h, Doppelwanddeckel

FR Sauteuse avec basculement manuel, cuve inox 50 lt. cm.71x37x18,5h, couvercle à double paroi

ES SARTÉN CON LEVANTAMIENTO MANUAL, CUBA DE ACERO INOX 50 LT. CM.71X37X18,5HH, TAPA DE DOBLE PARED

cm. 80 x 70,5 x 90h

cm. 83 x 77 x 111h / kg 135 / m³ 0,709

14 kW
12.040 kcal/h

€ 7.225,00

0,1 KW
230V~
50 Hz

BRM50-78G

08340851



BRASIERA A RIBALTAMENTO AUTOMATICO, VASCA INOX 50 LITRI CM.71X37X18,5H, COPERCHIO DOPPIA PARETE

EN Braising pan with automatic tilting, inox bowl 50 lt. cm.71x37x18,5h, double wall lid
DE Kippbratpfanne mit automatisch Kippung, Edelstahlschale 50 Lt. cm.71x37x18,5h, Doppelwanddeckel

FR Sauteuse avec basculement automatique, cuve inox 50 lt. cm.71x37x18,5h, couvercle à double paroi

ES SARTÉN CON LEVANTAMIENTO AUTOMATICO, CUBA DE ACERO INOX 50 LT. CM.71X37X18,5HH, TAPA DE DOBLE PARED

cm. 80 x 70,5 x 90h

cm. 83 x 77 x 111h / kg 139 / m³ 0,709

14 KW
12.040 kcal/h

€ 8.163,00

0,1 KW
230V~
50 Hz

PENTOLE ELETTRICHE
EN ELECTRIC KETTLE DE ELEKTRO-KOCHKESSEL FR MARMITES ÉLECTRIQUE ES MARMITAS ELECTRICAS
PI50-78ET

08160831



PENTOLA INDIRETTA ELETTRICA LT. 50 VASCA Ø CM. 40X48H (INCLUSA 1 TESTATA CHIUSURA PIANO MOD.TPA-7)

EN Electric indirect boiling pan 50 lts. Tank Ø cm. 40x48h (included 1 Head end filler strip mod.TPA-7)

DE Indirekter Elektro-kochkessel lt. 50 Becken Ø cm. 40x48h (inbegriffen 1 Abschluss-Element mod.TPA-7)

FR Marmite indirecte électrique lt. 50 Cuve Ø cm. 40x48h (inclus 1 Élément de jonction top mod.TPA-7)

ES **MARMITA DE CALEFACCIÓN INDIRECTA 50 LT. CUBA Ø CM. 40X48H (INCLUIDA 1 CHAPA DE CIERRE PARA TOP MOD.TPA-7)**

cm. 80 x 70,5 x 90h

 cm. 83 x 77 x 111h / kg 120 / m³ 0,709

 10,2 kW
 400V~3N
 50/60 Hz

€ 8.254,00
PI50A-78ET

08160832



PENTOLA INDIRETTA ELETTRICA LT. 50 VASCA Ø CM. 40X48H - CARICO AUTOMATICO INTERCAPEDINE (INCLUSA 1 TESTATA CHIUSURA PIANO MOD.TPA-7)

EN Electric indirect boiling pan 50 lts. Tank Ø cm. 40x48h - automatic water-charge of double jacket. (included 1 Head end filler strip mod.TPA-7)

DE Indirekter Elektro-kochkessel lt. 50 Becken Ø cm. 40x48h - automatische Wasserstandskontrolle im Zwischenmantel (inbegriffen 1 Abschluss-Element mod.TPA-7)

FR Marmite indirecte électrique lt. 50 Cuve Ø cm. 40x48h - remplissage automatique dans la double paroi (inclus 1 Élément de jonction top mod.TPA-7)

ES **MARMITA DE CALEFACCIÓN INDIRECTA 50 LT. CUBA Ø CM. 40X48H - CARGA AUTOMÁTICA DE LA CAMISA INTERCAMBIADOR (INCLUIDA 1 CHAPA DE CIERRE PARA TOP MOD.TPA-7)**

cm. 80 x 70,5 x 90h

 cm. 83 x 77 x 111h / kg 120 / m³ 0,709

 10,2 kW
 400V~3N
 50/60 Hz

€ 9.670,00
PENTOLE A GAS
EN GAS KETTLE DE GAS-KOCHKESSEL FR MARMITES À GAZ ES MARMITAS DE GAS
PD50-78G

08350850



PENTOLA DIRETTA GAS LT. 50 VASCA Ø CM. 40X48H (INCLUSA 1 TESTATA CHIUSURA PIANO MOD.TPA-7)

EN Gas direct boiling pan 50 lts - Tank Ø cm. 40x48h (included 1 Head end filler strip mod.TPA-7)

DE Direkter Gas-Kochkessel lt. 50 - Becken Ø cm. 40x48h (inbegriffen 1 Abschluss-Element mod.TPA-7)

FR Marmite directe à gaz lt. 50 - Cuve Ø cm. 40x48h (inclus 1 Élément de jonction top mod.TPA-7)

ES **MARMITA DE CALEFACCIÓN DIRECTA 50 LT. CUBA Ø CM. 40X48H (INCLUIDA 1 CHAPA DE CIERRE PARA TOP MOD.TPA-7)**

cm. 80 x 70,5 x 90h

 cm. 83 x 77 x 111h / kg 110 / m³ 0,709

 15,5 kW
 13.330 kcal/h

€ 6.964,00

 0,1 KW
 230V~
 50 Hz

PI50-78G

08350851



PENTOLA INDIRETTA A GAS LT. 50 VASCA Ø CM. 40X48H (INCLUSA 1 TESTATA CHIUSURA PIANO MOD.TPA-7)

EN Gas indirect boiling pan 50 lts. - Tank Ø cm. 40x48h (included 1 Head end filler strip mod.TPA-7)

DE Indirekter Gas-Kochkessel lt. 50 - Becken Ø cm. 40x48h (inbegriffen 1 Abschluss-Element mod.TPA-7)

FR Marmite indirecte à gaz lt. 50 - Cuve Ø cm. 40x48h (inclus 1 Élément de jonction top mod.TPA-7)

ES **MARMITA DE CALEFACCIÓN INDIRECTA A GAS LT. 50 CUBA Ø CM. 40X48H (INCLUIDA 1 CHAPA DE CIERRE PARA TOP MOD.TPA-7)**

cm. 80 x 70,5 x 90h

 cm. 83 x 77 x 111h / kg 120 / m³ 0,709

 15,5 kW
 13.330 kcal/h

€ 8.987,00

 0,1 KW
 230V~
 50 Hz

PI50A-78G

08350852



PENTOLA INDIRETTA A GAS LT. 50 VASCA Ø CM. 40X48H - CARICO AUTOMATICO INTERCAPEDINE (INCLUSA 1 TESTATA CHIUSURA PIANO MOD.TPA-7)

EN Gas indirect boiling pan 50 lts. - Tank Ø cm. 40x48h - automatic water-charge of double jacket. (included 1 Head end filler strip mod.TPA-7)

DE Indirekter Gas-Kochkessel lt. 50 - Becken Ø cm. 40x48h - automatische Wasserstandskontrolle im Zwischenmantel (inbegriffen 1 Abschluss-Element mod.TPA-7)

FR Marmite indirecte à gaz lt. 50 - Cuve Ø cm. 40x48h - remplissage automatique dans la double paroi (inclus 1 Élément de jonction top mod.TPA-7)

ES **MARMITA DE CALEFACCIÓN INDIRECTA A GAS LT. 50 CUBA Ø CM. 40X48H - CARGA AUTOMÁTICA DE LA CAMISA INTERCAMBIADOR (INCLUIDA 1 CHAPA DE CIERRE PARA TOP MOD.TPA-7)**

cm. 80 x 70,5 x 90h

 cm. 83 x 77 x 111h / kg 120 / m³ 0,709

 15,5 kW
 13.330 kcal/h

€ 10.364,00

 0,1 KW
 230V~
 50 Hz

PIANI LAVORO

EN WORK TOP DE ARBEITSPLATTE FR PLAN DE TRAVAIL ES ENCIMERA DE TRABAJO

PL-72

08010200



PIANO LAVORO SU MOBILE (INCLUSA 1 TESTATA CHIUSURA PIANO MOD.TPA-7)

€ 797,00

EN Worktop on cabinet (included 1 Head end filler strip mod.TPA-7)

DE Arbeitsplatte mit Unterbau (inbegriffen 1 Abschluss-Element mod.TPA-7)

FR Plan de travail sur armoire (inclus 1 Élément de jonction top mod.TPA-7)

ES **SOBRE DE TRABAJO SOBRE MUEBLE (INCLUIDA 1 CHAPA DE CIERRE PARA TOP MOD.TPA-7)**

cm. 20 x 70,5 x 90h

cm. 43 x 77 x 111h / kg 30 / m³ 0,368**PLS-73**

08010301



PIANO LAVORO SU MOBILE A GIORNO (INCLUSA 1 TESTATA CHIUSURA PIANO MOD. TPA-7)

€ 962,00

EN Worktop on open cabinet (included 1 Head end filler strip mod.TPA-7)

DE Arbeitsplatte mit offenem Unterbau (inbegriffen 1 Abschluss-Element mod.TPA-7)

FR Plan de travail sur armoire ouvert (inclus 1 Élément de jonction top mod.TPA-7)

ES **SOBRE DE TRABAJO SOBRE MUEBLE ABIERTO (INCLUIDA 1 CHAPA DE CIERRE PARA TOP MOD.TPA-7)**

cm. 30 x 70,5 x 90h

cm. 43 x 77 x 111h / kg 35 / m³ 0,368**PLS-74**

08010401



cm. 40 x 70,5 x 90h

€ 991,00cm. 43 x 77 x 111h / kg 40 / m³ 0,368**PLS-76**

08010601



cm. 60 x 70,5 x 90h

€ 1.498,00cm. 63 x 77 x 111h / kg 47 / m³ 0,538**PLS-78**

08010801



cm. 80 x 70,5 x 90h

€ 1.675,00cm. 83 x 77 x 111h / kg 55 / m³ 0,709

PL-73

08010300



PIANO LAVORO SU MOBILE A GIORNO CASSETTO - 1 BACINELLA INOX CM 19X50X15H (INCLUSA 1 TESTATA CHIUSURA PIANO MOD.TPA-7)

€ 1.307,00

- EN** Worktop on open cabinet Drawer - 1 inox container cm 19x50x15h (included 1 Head end filler strip mod.TPA-7)
- DE** Arbeitsplatte mit offenem Unterbau Schublade - 1 Chromnickelstahlbehälter cm 19x50x15h (inbegriffen 1 Abschluss-Element mod.TPA-7)
- FR** Plan de travail sur armoire ouvert Tiroir - Bac en inox cm 19x50x15h (inclus 1 Élément de jonction top mod.TPA-7)
- ES** **SOBRE DE TRABAJO SOBRE MUEBLE ABIERTO CAJÓN - 1 CONTENEDOR CM 19X50X15H DE ACERO INOX (INCLUIDA 1 CHAPA DE CIERRE PARA TOP MOD.TPA-7)**

cm. 30 x 70,5 x 90h
 cm. 43 x 77 x 111h / kg 40 / m³ 0,368

PL-74

08010400



PIANO LAVORO SU MOBILE A GIORNO CASSETTO CON 1 BACINELLA GN 1/1 15H INOX (INCLUSA 1 TESTATA CHIUSURA PIANO MOD.TPA-7)

€ 1.271,00

- EN** Worktop on open cabinet Drawer with 1 inox container GN 1/1 15h (included 1 Head end filler strip mod.TPA-7)
- DE** Arbeitsplatte mit offenem Unterbau Schublade mit 1 GN 1/1 15h aus Edelstahl (inbegriffen 1 Abschluss-Element mod.TPA-7)
- FR** Plan de travail sur armoire ouvert Tiroir avec bac en inox GN 1/1 15h. (inclus 1 Élément de jonction top mod.TPA-7)
- ES** **SOBRE DE TRABAJO SOBRE MUEBLE ABIERTO CAJÓN CON 1 CONTENEDOR GN 1/1 15H DE ACERO INOX (INCLUIDA 1 CHAPA DE CIERRE PARA TOP MOD.TPA-7)**

cm. 40 x 70,5 x 90h
 cm. 43 x 77 x 111h / kg 45 / m³ 0,368

PL-76

08010600



PIANO LAVORO SU MOBILE A GIORNO CASSETTO - 1 BACINELLA INOX CM 49X50X15H (INCLUSA 1 TESTATA CHIUSURA PIANO MOD.TPA-7)

€ 1.795,00

- EN** Worktop on open cabinet Drawer - 1 inox container cm 49x50x15h (included 1 Head end filler strip mod.TPA-7)
- DE** Arbeitsplatte mit offenem Unterbau Schublade - 1 Chromnickelstahlbehälter cm 49x50x15h (inbegriffen 1 Abschluss-Element mod.TPA-7)
- FR** Plan de travail sur armoire ouvert Tiroir - Bac en inox cm 49x50x15h (inclus 1 Élément de jonction top mod.TPA-7)
- ES** **SOBRE DE TRABAJO SOBRE MUEBLE ABIERTO CAJÓN - 1 CONTENEDOR CM 49X50X15H DE ACERO INOX (INCLUIDA 1 CHAPA DE CIERRE PARA TOP MOD.TPA-7)**

cm. 60 x 70,5 x 90h
 cm. 63 x 77 x 111h / kg 56 / m³ 0,538

PL-78

08010800



PIANO LAVORO SU MOBILE A GIORNO CASSETTO CON 2 BACINELLE GN 1/1 15H INOX (INCLUSA 1 TESTATA CHIUSURA PIANO MOD.TPA-7)

€ 2.002,00

- EN** Worktop on open cabinet Drawer with 2 inox containers GN 1/1 15h (included 1 Head end filler strip mod.TPA-7)
- DE** Arbeitsplatte mit offenem Unterbau Schublade mit 2 GN 1/1 15h aus Edelstahl (inbegriffen 1 Abschluss-Element mod.TPA-7)
- FR** Plan de travail sur armoire ouvert Tiroir avec 2 bacs en inox GN 1/1 15h (inclus 1 Élément de jonction top mod.TPA-7)
- ES** **SOBRE DE TRABAJO SOBRE MUEBLE ABIERTO CAJÓN CON 2 CONTENEDORES GN 1/1 15H DE ACERO INOX (INCLUIDA 1 CHAPA DE CIERRE PARA TOP MOD.TPA-7)**

cm. 80 x 70,5 x 90h
 cm. 83 x 77 x 111h / kg 67 / m³ 0,709

LAVELLI
EN SINK UNIT DE SPÜLBECKEN FR ÉVIER ES FREGADEROS
LA-74

08020400



LAVELLO SU MOBILE A GIORNO RUBINETTO A LEVA - VASCA CM. 30X35X15H (INCLUSA 1 TESTATA CHIUSURA PIANO MOD.TPA-7)

€ 1.596,00

- EN** Sink unit on open cabinet - Lever type tap. Bowl cm. 30x35x15h (included 1 Head end filler strip mod.TPA-7)
- DE** Spülbecken Einhebel-Mischbatterie mit offenem Unterbau - Becken cm. 30x35x15h (inbegriffen 1 Abschluss-Element mod.TPA-7)
- FR** Bac-évier sur armoire ouvert avec robinetterie - Bac cm. 30x35x15h (inclus 1 Élément de jonction top mod.TPA-7)
- ES** **FREGADERO SOBRE MUEBLE ABIERTO - GRIFO A PALANCA - PILETA CM. 30X35X15H (INCLUIDA 1 CHAPA DE CIERRE PARA TOP MOD.TPA-7)**

cm. 40 x 70,5 x 90h
 cm. 43 x 77 x 111h / kg 45 / m³ 0,368

70 SUPERLOTUS TOUCH



70 SUPERLOTUS
TOUCH

PIANI COTTURA A INDUZIONE - TOUCH
EN INDUCTION BOILING UNIT - TOUCH DE INDUKTIONNS-KOCHPLATTEN - TOUCH FR PLAN DE CUISSON À INDUCTION - TOUCH ES SOBRES DE COCCIÓN POR INDUCCIÓN - TOUCH
PCI-74ETT
0803A433

PIANO COTTURA INDUZIONE TRIFASE, TOUCH SCREEN 4,3" CON 10 LIVELLI DI POTENZA."ENERGY SAVING, WIFI E CLOUD". 2 TIMER. N. 2 ZONE - VETRO CM.35X57 (INCLUSA 1 TESTATA CHIUSURA PIANO MOD.TPA-7)

EN Three-phase induction cooking, Touch Screen 4,3" with 10 power levels. "Energy Saving, WiFi and CLOUD". Functions: 2 timerr. 2 zones - glass cm.35x57 (included 1 Head end filler strip mod.tpa-7)

DE Induktions-Kochplatte dreiphasig, Touch Screen 4,3" mit 10 Leistungsstufen. "Energy Saving, WiFi und CLOUD". Funktionen: 2 timer. 2 zonen - Glas 35x57 cm (inbegriffen 1 Abschluss-Element mod.tpa-7)

FR Plan de cuisson à induction triphasé, Touch Screen 4,3" avec 10 niveaux de puissance. "Energy Saving, WiFi et CLOUD". Fonctions: 2 timer. N. 2 zones - Verre cm.35x57 (inclus 1 Élément de jonction top mod.tpa-7)

ES **ENCIMERA INDUCCIÓN TRIFÁSICA, TOUCH SCREEN 4,3" CON 10 NIVELES DE POTENCIA. "ENERGY SAVING, WIFI Y CLOUD". FUNCIONES: 2 TIMER . - 2 ZONAS - VIDRIO CM.35X57 (INCLUIDA 1 CHAPA DE CIERRE PARA TOP MOD.TPA-7)**

cm. 40 x 70,5 x 90h

cm. 43 x 77 x 111h / kg 40 / m³ 0,368

€ 8.893,00
 ⚡ 10 kW
 400V~3N
 50/60 Hz

PCIW-74ETT
0803A434

PIANO COTTURA INDUZIONE TRIFASE "WOK", TOUCH SCREEN 4,3" CON 10 LIVELLI DI POTENZA."ENERGY SAVING, WIFI E CLOUD". 2 TIMER. N. 1 ZONA - VETRO Ø 30 CM. (INCLUSA 1 TESTATA CHIUSURA PIANO MOD.TPA-7)

EN Three-phase induction cooking "WOK", Touch Screen 4,3" with 10 power levels. "Energy Saving, WiFi and CLOUD". Functions: 2 timerr. 1 zone - glass Ø 30 cm (included 1 Head end filler strip mod.tpa-7)

DE Induktions-Kochplatte "WOK" dreiphasig, Touch Screen 4,3" mit 10 Leistungsstufen. "Energy Saving, WiFi und CLOUD". Funktionen: 2 timer. 1 zonen - Glas Ø 30 cm (inbegriffen 1 Abschluss-Element mod.tpa-7)

FR Plan de cuisson à induction "WOK" triphasé, Touch Screen 4,3" avec 10 niveaux de puissance. "Energy Saving, WiFi et CLOUD". Fonctions: 2 timer. N. 1 zone - Verre cm Ø 30 (inclus 1 Élément de jonction top mod.tpa-7)

ES **ENCIMERA INDUCCIÓN "WOK" TRIFÁSICA, TOUCH SCREEN 4,3" CON 10 NIVELES DE POTENCIA. "ENERGY SAVING, WIFI Y CLOUD". FUNCIONES: 2 TIMER . 1 ZONA - VIDRIO Ø 30 CM (INCLUIDA 1 CHAPA DE CIERRE PARA TOP MOD.TPA-7)**

cm. 40 x 70,5 x 90h

cm. 43 x 77 x 111h / kg 38 / m³ 0,368

€ 6.511,00
 ⚡ 4,5 kW
 400V~3N
 50/60 Hz

PCI-78ETT
0803A833

PIANO COTTURA INDUZIONE TRIFASE, TOUCH SCREEN 4,3" CON 10 LIVELLI DI POTENZA"ENERGY SAVING, WIFI E CLOUD". 2 TIMER. N. 4 ZONE - VETRO CM.75X57 (INCLUSA 1 TESTATA CHIUSURA PIANO MOD.TPA-7)

EN Three-phase induction cooking, Touch Screen 4,3" with 10 power levels. "Energy Saving, WiFi and CLOUD". Functions: 2 timerr. 4 zones - glass cm.75x57 (included 1 Head end filler strip mod.tpa-7)

DE Induktions-Kochplatte dreiphasig, Touch Screen 4,3" mit 10 Leistungsstufen. "Energy Saving, WiFi und CLOUD". Funktionen: 2 timer. 4 zonen - Glas 75x57 cm (inbegriffen 1 Abschluss-Element mod.tpa-7)

FR Plan de cuisson à induction triphasé, Touch Screen 4,3" avec 10 niveaux de puissance. "Energy Saving, WiFi et CLOUD". Fonctions: 2 timer. N. 4 zones - Verre cm.75x57 (inclus 1 Élément de jonction top mod.tpa-7)

ES **ENCIMERA INDUCCIÓN TRIFÁSICA, TOUCH SCREEN 4,3" CON 10 NIVELES DE POTENCIA. "ENERGY SAVING, WIFI Y CLOUD". FUNCIONES: 2 TIMER . 4 ZONAS - VIDRIO CM.75X57 (INCLUIDA 1 CHAPA DE CIERRE PARA TOP MOD.TPA-7)**

cm. 80 x 70,5 x 90h

cm. 83 x 77 x 111h / kg 70 / m³ 0,709

€ 16.781,00
 ⚡ 20 kW
 400V~3N
 50/60 Hz

TUTTOPIANO INDUZIONE - TOUCH

EN INDUCTION SOLID TOP - TOUCH DE INDUKTIONNS-KOCHPLATTEN - TOUCH FR TOUTE PLAQUE A INDUCTION - TOUCH ES PLACA DE COCCIÓN POR INDUCCIÓN - TOUCH

TPI-78ETT
 0812A833

TUTTOPIANO INDUZIONE TRIFASE, TOUCH SCREEN 4,3" CON 10 LIVELLI DI POTENZA. "ENERGY SAVING, WIFI E CLOUD". 2 TIMER. N.4X2 ZONE - VETRO CM.75X57 (INCLUSA 1 TESTATA CHIUSURA PIANO MOD.TPA-7)

EN Three-phase induction Solid top, Touch Screen 4,3" with 10 power levels. "Energy Saving, WiFi and CLOUD". Functions: 2 timer. 4x2 zones -glass cm.75x57 (included 1 Head end filler strip mod.tpa-7)

DE Induktions-Kochplatte dreiphasig, Touch Screen 4,3" mit 10 Leistungsstufen. "Energy Saving, WiFi und CLOUD". Funktionen: 2 timer. 4x2 zonen - Glas 75x57 cm (inbegriffen 1 Abschluss-Element mod.tpa-7)

FR Toute plaque à induction triphasé, Touch Screen 4,3" avec 10 niveaux de puissance. "Energy Saving, WiFi et CLOUD". Fonctions: 2 timer. N.4x2 zones - Verre cm.75x57 (inclus 1 Élément de jonction top mod.tpa-7)

ES PLACA RADIANTE INDUCCIÓN TRIFÁSICA, TOUCH SCREEN 4,3" CON 10 NIVELES DE POTENCIA. "ENERGY SAVING, WIFI Y CLOUD". FUNCIONES: 2 TIMER . 4X2 ZONAS - VIDRIO CM.75X57 (INCLUIDA 1 CHAPA DE CIERRE PARA TOP MOD.TPA-7)

cm. 80 x 70,5 x 90h

cm. 83 x 77 x 111h / kg 89 / m³ 0,709

21 kW € 22.055,00
 400V~3N
 50/60 Hz

TUTTAPIASTRA MULTIFUNZIONE ELETTRICO - TOUCH

EN ELECTRIC MULTIFUNCTION SOLID TOP - TOUCH DE ELEKTRO-MULTIFUNKTIONSKOCHPLATTEN - TOUCH FR TOUTE PLAQUE MULTIFONCTION ÉLECTRIQUE - TOUCH ES PLACA DE COCCIÓN MULTIFUNCIÓN ELECTRICAS - TOUCH

TPK-78ETT
 0812A830

TUTTA PIASTRA IN BIMETALLO PER COTTURE DIRETTE E INDIRECTE SU MOBILE A GIORNO, TOUCH SCREEN 4,3", TEMPERATURA 400°C CON CONTROLLO PID. "ENERGY SAVING, WIFI E CLOUD". FUNZIONI: 2 TIMER. PIASTRA CM. 71X48 - 4 ZONE (INCLUSA 1 TESTATA CHIUSURA PIANO MOD.TPA-7)

EN Compound Solid top for direct and indirect cooking on open unit, Touch Screen 4,3", temperature 400°C with PID control. "Energy Saving, WiFi and CLOUD". Functions: 2 timer. Plate cm. 71x48 (included 1 Head end filler strip mod.tpa-7)

DE Compound Kochplatten zum direkten und indirekten Garen auf offenem Unterbau, Touch Screen 4,3", Temperatur 400°C mit PID-Regelung. "Energy Saving, WiFi und CLOUD". Funktionen: 2 timer. Platte cm. 71x48 (inbegriffen 1 Abschluss-Element mod.tpa-7)

FR Toute plaque en Compound pour la cuisson directe et indirecte sur meuble ouvert, Touch Screen 4,3", température 400°C avec contrôle PID. "Energy Saving, WiFi et CLOUD". Fonctions: 2 timer. Plaque cm. 71x48 (inclus 1 Élément de jonction top mod.tpa-7)

ES PLACA RADIANTE EN COMPOUND PARA COCCIÓN DIRECTA E INDIRECTA SOBRE MUEBLE ABIERTO, TOUCH SCREEN 4,3", TEMPERATURA 400°C CON CONTROL PID. "ENERGY SAVING, WIFI Y CLOUD". FUNCIONES: 2 TIMER. PLACA CM. 71X48 (INCLUIDA 1 CHAPA DE CIERRE PARA TOP MOD.TPA-7)

cm. 80 x 70,5 x 90h

cm. 83 x 77 x 111h / kg 110 / m³ 0,709

10 kW € 8.954,00
 400V~3N
 50/60 Hz

CUOCIPASTA ELETTRICI - TOUCH
EN ELECTRIC PASTA COOKERS - TOUCH DE ELEKTRO NUDELKOCHER - TOUCH FR CUISEURS DE PÂTES ÉLECTRIQUE - TOUCH ES CUECEPASTAS ELECTRICAS - TOUCH
CPA-74ETT
 0810A435

CUOCIPASTA TRIFASE LT. 25 VASCA CM.30,5X33X32,7H. TOUCH SCREEN 4,3", TEMPERATURA FINO A 80°C POI MAX. "ENERGY SAVING, WIFI E CLOUD". FUNZIONI: 4 TIMER, COTTURA VAPORE, 3 VELOCITÀ RABBOCCO LENTO, SONDA AL CUORE PER COTTURE SOTTOVUOTO (OPTIONAL). CARICO ACQUA AUTOMATICO CON SENSORE DI LIVELLO - SFIORATORE + SCARICO A PAVIMENTO (CESTI ESCLUSI) (INCLUSA 1 TESTATA CHIUSURA PIANO MOD.TPA-7)

EN Pasta cooker threephase 25 lts. Tank cm.30,5x33x32,7h. Touch Screen 4,3", temperature up to 80°C then MAX. "Energy Saving, WiFi and CLOUD". Functions: 4 timer, steam cooking, 3 water loading speeds, core probe for sous vide cooking (OPTIONAL). Automatic Water loading with level sensor - overflow device and floor draining (BASKETS EXCLUDED) (included 1 Head end filler strip mod.tpa-7)

DE Nudelkocher dreiphasig lt. 25 - Becken cm.30,5x33x32,7h. Touch Screen 4,3", Temperatur bis 80°C, dann MAX. "Energy Saving, WiFi und CLOUD". Funktionen: 4 timer, Dampfgaren, 3 Wasserladegeschwindigkeiten, Kerntemperaturfühler für Sous-Vide-Garen (OPTIONAL). Automatische Wasser Beladung mit Niveauregulierung + Überlauf-Vorrichtung und Ablauf am Boden (KORB AUSGESCHLOSSEN) (inbegriffen 1 Abschluss-Element mod.tpa-7)

FR Cuiseur a pates triphase lt. 25 Cuve cm.30,5x33x32,7h. Touch Screen 4,3", température jusqu'à 80°C puis MAX. "Energy Saving, WiFi et CLOUD". Fonctions: 4 timer, cuisson vapeur, 3 vitesses de chargement d'eau, sonde à cœur pour cuisson sous vide (OPTIONAL). Chargement automatique de l'eau avec sensor de niveau, trop plein Système de vidange au sol (PANIERS EXCLUS) (inclus 1 Élément de jonction top mod.tpa-7)

ES CUECE PASTA TRIFÁSICO LT. 25 - CUBA CM.30,5X33X32,7H.TOUCH SCREEN 4,3", TEMPERATURA HASTA 80°C Y LUEGO MAX. "ENERGY SAVING, WIFI Y CLOUD". FUNCIONES: 4 TIMER, COCCIÓN AL VAPOR, 3 VELOCIDADES DE CARGA DE AGUA, SONDA AL CORAZÓN PARA COCCIÓN AL VACÍO (OPTIONAL). CARGA AUTOMÁTICA DE AGUA CON SENSOR DE NIVEL + VERTEDERO + DESCARGA A PAVIMENTO. (CESTAS EXCLUIDAS) (INCLUIDA 1 CHAPA DE CIERRE PARA TOP MOD.TPA-7)

cm. 40 x 70,5 x 90h

 cm. 43 x 77 x 111h / kg 48 / m³ 0,368

 7,8 kW
 400V~3N
 230V~3
 50/60 Hz

€ 4.662,00
COMBINAZIONI

 • Combinations / • Zusammenstellungen
 • Combinaisons / • Combinación múltiple

CPA-76ETT

0810A635



CUOCIPASTA TRIFASE LT. 40 VASCA CM.51X30,7X32,7H. TOUCH SCREEN 4,3", TEMPERATURA FINO A 80°C POI MAX. "ENERGY SAVING, WIFI E CLOUD". FUNZIONI: 4 TIMER, COTTURA VAPORE, 3 VELOCITÀ RABBOCCO LENTO, SONDA AL CUORE PER COTTURE SOTTOVUOTO (OPTIONAL). CARICO ACQUA AUTOMATICO CON SENSORE DI LIVELLO - SFIORATORE + SCARICO A PAVIMENTO (CESTI ESCLUSI) (INCLUSA 1 TESTATA CHIUSURA PIANO MOD.TPA-7)

13,5 kW
400V~3N
50/60 Hz

€ 5.535,00

EN Pasta cooker threephase 40 lts. Tank cm.51x30,7x32,7h. Touch Screen 4,3", temperature up to 80°C then MAX. "Energy Saving, WiFi and CLOUD". Functions: 4 timer, steam cooking, 3 water loading speeds, core probe for sous vide cooking (OPTIONAL). Automatic Water loading with level sensor - overflow device and floor draining (BASKETS EXCLUDED) (included 1 Head end filler strip mod.tpa-7)

DE Nudelkocher dreiphasig lt. 40 - Becken cm.51x30,7x32,7h. Touch Screen 4,3", Temperatur bis 80°C, dann MAX. "Energy Saving, WiFi und CLOUD". Funktionen: 4 timer, Dampfgaren, 3 Wasserladegeschwindigkeiten, Kerntemperaturfühler für Sous-Vide-Garen (OPTIONAL). Automatische Wasser Beladung mit Niveauregulierung + Überlauf-Vorrichtung und Ablauf am Boden (KORB AUSGESCHLOSSEN) (inbegriffen 1 Abschluss-Element mod.tpa-7)

FR Cuisseur a pates triphase lt. 40 Cuve cm.51x30,7x32,7h. Touch Screen 4,3", température jusqu'à 80°C puis MAX. "Energy Saving, WiFi et CLOUD". Fonctions: 4 timer, cuisson vapeur, 3 vitesses de chargement d'eau, sonde à cœur pour cuisson sous vide (OPTIONAL). Chargement automatique de l'eau avec sensor de niveau, trop plein Système de vidange au sol (PANIERS EXCLUS) (inclus 1 Élément de jonction top mod.tpa-7)

ES CUECE PASTA TRIFÁSICO LT. 40 - CUBA CM.51X30,7X32,7H.TOUCH SCREEN 4,3", TEMPERATURA HASTA 80°C Y LUEGO MAX. "ENERGY SAVING, WIFI Y CLOUD". FUNCIONES: 4 TIMER, COCCIÓN AL VAPOR, 3 VELOCIDADES DE CARGA DE AGUA, SONDA AL CORAZÓN PARA COCCIÓN AL VACÍO (OPTIONAL). CARGA AUTOMÁTICA DE AGUA CON SENSOR DE NIVEL + VERTEDERO + DESCARGA A PAVIMENTO. (CESTAS EXCLUIDAS) (INCLUIDA 1 CHAPA DE CIERRE PARA TOP MOD.TPA-7)

cm. 60 x 70,5 x 90h

cm. 63 x 77 x 111h / kg 78 / m³ 0,538

COMBINAZIONI

- Combinations / • Zusammenstellungen
- Combinaisons / • Combinación múltiple



CPA-78ETT

0810A835



CUOCIPASTA TRIFASE LT. 25+25 2 VASCHE CM. 30,5X33X32,7H. TOUCH SCREEN 4,3", TEMPERATURA FINO A 80°C POI MAX. "ENERGY SAVING, WIFI E CLOUD". FUNZIONI: 4 TIMER, COTTURA VAPORE, 3 VELOCITÀ RABBOCCO LENTO, SONDA AL CUORE PER COTTURE SOTTOVUOTO (OPTIONAL). CARICO ACQUA AUTOMATICO CON SENSORE DI LIVELLO - SFIORATORE + SCARICO A PAVIMENTO (CESTI ESCLUSI) (INCLUSA 1 TESTATA CHIUSURA PIANO MOD.TPA-7)

EN Pasta cooker threephase 25+25 lts. 2 Tanks cm. 30,5x33x32,7h. Touch Screen 4,3", temperature up to 80°C then MAX. "Energy Saving, WiFi and CLOUD". Functions: 4 timer, steam cooking, 3 water loading speeds, core probe for sous vide cooking (OPTIONAL). Automatic Water loading with level sensor - overflow device and floor draining (BASKETS EXCLUDED) (included 1 Head end filler strip mod.tpa-7)

DE Nudelkocher dreiphasig lt. 25+25 2 Becken cm. 30,5x33x32,7h. Touch Screen 4,3", Temperatur bis 80°C, dann MAX. "Energy Saving, WiFi und CLOUD". Funktionen: 4 timer, Dampfgaren, 3 Wasserladegeschwindigkeiten, Kerntemperaturfühler für Sous-Vide-Garen (OPTIONAL). Automatische Wasser Beladung mit Niveauregulierung + Überlauf-Vorrichtung und Ablauf am Boden (KORB AUSGESCHLOSSEN) (inbegriffen 1 Abschluss-Element mod.tpa-7)

FR Cuisneur a pates triphase lt. 25+25 2 Cuves cm.30,5x33x32,7h. Touch Screen 4,3", température jusqu'à 80°C puis MAX. "Energy Saving, WiFi et CLOUD". Fonctions: 4 timer, cuisson vapeur, 3 vitesses de chargement d'eau, sonde à cœur pour cuisson sous vide (OPTIONAL). Chargement automatique de l'eau avec sensor de niveau, trop plein Système de vidange au sol (PANIERS EXCLUS) (inclus 1 Élément de jonction top mod.tpa-7)

ES CUECE PASTA TRIFÁSICO 25+25 LT. 2 CUBAS CM. 30,5X33X32,7H. TOUCH SCREEN 4,3", TEMPERATURA HASTA 80°C Y LUEGO MAX. "ENERGY SAVING, WIFI Y CLOUD". FUNCIONES: 4 TIMER, COCCIÓN AL VAPOR, 3 VELOCIDADES DE CARGA DE AGUA, SONDA AL CORAZÓN PARA COCCIÓN AL VACÍO (OPTIONAL). CARGA AUTOMÁTICA DE AGUA CON SENSOR DE NIVEL + VERTEDERO + DESCARGA A PAVIMENTO. (CESTAS EXCLUIDAS) (INCLUIDA 1 CHAPA DE CIERRE PARA TOP MOD.TPA-7)

cm. 80 x 70,5 x 90h

cm. 83 x 77 x 111h / kg 82 / m³ 0,709

15,6 kW
400V~3N
230V~3
50/60 Hz

€ 7.832,00
COMBINAZIONI

- Combinations / • Zusammenstellungen
- Combinaisons / • Combinación múltiple

FRY-TOP ELETTRICI - TOUCH

EN ELECTRIC GRIDDLE - TOUCH **DE** ELEKTROGRIDDLEPLATTEN - TOUCH **FR** FRY-TOP ÉLECTRIQUE - TOUCH **ES** FRY-TOP ELECTRICO - TOUCH

FTL-74ETTS

0806A434



FRY-TOP ELETTRICO LISCIO CROMATO SUPERCHROME (MOCA APPROVED), SU MOBILE A GIORNO, TOUCH SCREEN 4,3", TEMPERATURA 300°C CON CONTROLLO PID. "ENERGY SAVING, WIFI E CLOUD". FUNZIONI: 2 TIMER, SONDA AL CUORE PER COTTURE DIRETTE (OPTIONAL). PIASTRA CM.36X51 (INCLUSA 1 TESTATA CHIUSURA PIANO MOD.TPA-7)

EN Electric Fry-top smooth chromed griddle SUPERCHROME (Moca Approved), on open cabinet, Touch Screen 4,3", temperature 300°C with PID control. "Energy Saving, WiFi and CLOUD". Functions: 2 timer, core probe for direct cooking (OPTIONAL). Plate cm.36x51 (included 1 Head end filler strip mod.tpa-7)

DE Griddleplatte elektrische glatt hartverchromt SUPERCHROME (Moca Approved), mit offenem Unterbau, Touch Screen 4,3", Temperatur 300°C mit PID-Regelung. "Energy Saving, WiFi und CLOUD". Funktionen: 2 timer, Kerntemperaturfühler für direktes Garen (OPTIONAL). Platte cm.36x51 (inbegriffen 1 Abschluss-Element mod.tpa-7)

FR Plaque électriques lisse chromée SUPERCHROME (Moca Approved), sur armoire ouvert, Touch Screen 4,3", température 300°C avec contrôle PID. "Energy Saving, WiFi et CLOUD". Fonctions: 2 timer, sonde à cœur pour cuisson directe (OPTIONAL). Plaque cm.36x51 (inclus 1 Élément de jonction top mod.tpa-7)

ES FRY-TOP ELÉCTRICO LISO CROMADO SUPERCHROME (MOCA APPROVED), SOBRE MUEBLE ABIERTO, TOUCH SCREEN 4,3", TEMPERATURA 300°C CON CONTROL PID. "ENERGY SAVING, WIFI Y CLOUD". FUNCIONES: 2 TIMER, SONDA AL CORAZÓN PARA COCCIÓN DIRECTA (OPTIONAL). PLANCHA CM.36X51 (INCLUIDA 1 CHAPA DE CIERRE PARA TOP MOD.TPA-7)

cm. 40 x 70,5 x 90h

cm. 43 x 77 x 111h / kg 64 / m³ 0,368

5,55 kW
400V~3N
230V~3
50/60 Hz

€ 3.622,00

FTR-74ETTS

0806A436



FRY-TOP ELETTRICO RIGATO CROMATO SUPERCHROME (MOCA APPROVED), SU MOBILE A GIORNO, TOUCH SCREEN 4,3", TEMPERATURA 300°C CON CONTROLLO PID. "ENERGY SAVING, WIFI E CLOUD". FUNZIONI: 2 TIMER, SONDA AL CUORE PER COTTURE DIRETTE (OPTIONAL). PIASTRA CM.36X51 (INCLUSA 1 TESTATA CHIUSURA PIANO MOD.TPA-7)

EN Electric Fry-top grooved chromed griddle SUPERCHROME (Moca Approved), on open cabinet, Touch Screen 4,3", temperature 300°C with PID control. "Energy Saving, WiFi and CLOUD". Functions: 2 timer, core probe for direct cooking (OPTIONAL). Plate cm.36x51 (included 1 Head end filler strip mod.tpa-7)

DE Griddleplatte elektrische gerillt hartverchromt SUPERCHROME (Moca Approved), mit offenem Unterbau, Touch Screen 4,3", Temperatur 300°C mit PID-Regelung. "Energy Saving, WiFi und CLOUD". Funktionen: 2 timer, Kerntemperaturfühler für direktes Garen (OPTIONAL). Platte cm.36x51 (inbegriffen 1 Abschluss-Element mod.tpa-7)

FR Plaque électriques nervurée chromée SUPERCHROME (Moca Approved), sur armoire ouvert, Touch Screen 4,3", température 300°C avec contrôle PID. "Energy Saving, WiFi et CLOUD". Fonctions: 2 timer, sonde à cœur pour cuisson directe (OPTIONAL). Plaque cm.36x51 (inclus 1 Élément de jonction top mod.tpa-7)

ES **FRY-TOP ELÉCTRICO ESTRIADO CROMADO SUPERCHROME (MOCA APPROVED), SOBRE MUEBLE ABIERTO, TOUCH SCREEN 4,3", TEMPERATURA 300°C CON CONTROL PID. "ENERGY SAVING, WIFI Y CLOUD". FUNCIONES: 2 TIMER, SONDA AL CORAZÓN PARA COCCIÓN DIRECTA (OPTIONAL). PLANCHA CM.36X51 (INCLUIDA 1 CHAPA DE CIERRE PARA TOP MOD.TPA-7)**

cm. 40 x 70,5 x 90h

cm. 43 x 77 x 111h / kg 64 / m³ 0,368

5,55 kW
400V~3N
230V~3
50/60 Hz

€ 3.723,00**FTL-76ETTS**

0806A634



FRY-TOP ELETTRICO LISCIO CROMATO SUPERCHROME (MOCA APPROVED), SU MOBILE A GIORNO, TOUCH SCREEN 4,3", TEMPERATURA 300°C CON CONTROLLO PID. "ENERGY SAVING, WIFI E CLOUD". FUNZIONI: 2 TIMER, SONDA AL CUORE PER COTTURE DIRETTE (OPTIONAL). PIASTRA CM.56X51 (INCLUSA 1 TESTATA CHIUSURA PIANO MOD.TPA-7)

EN Electric Fry-top smooth chromed griddle SUPERCHROME (Moca Approved), on open cabinet, Touch Screen 4,3", temperature 300°C with PID control. "Energy Saving, WiFi and CLOUD". Functions: 2 timer, core probe for direct cooking (OPTIONAL). Plate cm.56x51 (included 1 Head end filler strip mod.tpa-7)

DE Griddleplatte elektrische glatt hartverchromt SUPERCHROME (Moca Approved), mit offenem Unterbau, Touch Screen 4,3", Temperatur 300°C mit PID-Regelung. "Energy Saving, WiFi und CLOUD". Funktionen: 2 timer, Kerntemperaturfühler für direktes Garen (OPTIONAL). Platte cm.56x51 (inbegriffen 1 Abschluss-Element mod.tpa-7)

FR Plaque électriques lisse chromée SUPERCHROME (Moca Approved), sur armoire ouvert, Touch Screen 4,3", température 300°C avec contrôle PID. "Energy Saving, WiFi et CLOUD". Fonctions: 2 timer, sonde à cœur pour cuisson directe (OPTIONAL). Plaque cm.56x51 (inclus 1 Élément de jonction top mod.tpa-7)

ES **FRY-TOP ELÉCTRICO LISO CROMADO SUPERCHROME (MOCA APPROVED), SOBRE MUEBLE ABIERTO, TOUCH SCREEN 4,3", TEMPERATURA 300°C CON CONTROL PID. "ENERGY SAVING, WIFI Y CLOUD". FUNCIONES: 2 TIMER, SONDA AL CORAZÓN PARA COCCIÓN DIRECTA (OPTIONAL). PLANCHA CM.56X51 (INCLUIDA 1 CHAPA DE CIERRE PARA TOP MOD.TPA-7)**

cm. 60 x 70,5 x 90h

cm. 63 x 77 x 111h / kg 78 / m³ 0,538

7,4 kW
400V~3N
50/60 Hz

€ 4.136,00**FTLR-76ETTS**

0806A635



FRY-TOP ELETTRICO 1/2 RIGATO + 1/2 LISCIO CROMATO SUPERCHROME (MOCA APPROVED), SU MOBILE A GIORNO, TOUCH SCREEN 4,3", TEMPERATURA 300°C CON CONTROLLO PID. "ENERGY SAVING, WIFI E CLOUD". FUNZIONI: 2 TIMER, SONDA AL CUORE PER COTTURE DIRETTE (OPTIONAL). PIASTRA CM.56X51 (INCLUSA 1 TESTATA CHIUSURA PIANO MOD.TPA-7)

EN Electric Fry-top 1/2 grooved + 1/2 smooth chromed griddle SUPERCHROME (Moca Approved), on open cabinet, Touch Screen 4,3", temperature 300°C with PID control. "Energy Saving, WiFi and CLOUD". Functions: 2 timer, core probe for direct cooking (OPTIONAL). Plate cm.56x51 (included 1 Head end filler strip mod.tpa-7)

DE Griddleplatte elektrische 1/2 gerillt + 1/2 glatt hartverchromt SUPERCHROME (Moca Approved), mit offenem Unterbau, Touch Screen 4,3", Temperatur 300°C mit PID-Regelung. "Energy Saving, WiFi und CLOUD". Funktionen: 2 timer, Kerntemperaturfühler für direktes Garen (OPTIONAL). Platte cm.56x51 (inbegriffen 1 Abschluss-Element mod.tpa-7)

FR Plaque électriques 1/2 nervurée + 1/2 lisse chromée SUPERCHROME (Moca Approved), sur armoire ouvert, Touch Screen 4,3", température 300°C avec contrôle PID. "Energy Saving, WiFi et CLOUD". Fonctions: 2 timer, sonde à cœur pour cuisson directe (OPTIONAL). Plaque cm.56x51 (inclus 1 Élément de jonction top mod.tpa-7)

ES **FRY-TOP ELÉCTRICO 1/2 ESTRIADO + 1/2 LISO CROMADO SUPERCHROME (MOCA APPROVED), SOBRE MUEBLE ABIERTO, TOUCH SCREEN 4,3", TEMPERATURA 300°C CON CONTROL PID. "ENERGY SAVING, WIFI Y CLOUD". FUNCIONES: 2 TIMER, SONDA AL CORAZÓN PARA COCCIÓN DIRECTA (OPTIONAL). PLANCHA CM.56X51 (INCLUIDA 1 CHAPA DE CIERRE PARA TOP MOD.TPA-7)**

cm. 60 x 70,5 x 90h

cm. 63 x 77 x 111h / kg 78 / m³ 0,538

7,4 kW
400V~3N
50/60 Hz

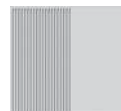
€ 4.284,00

FTL-78ETTS

0806A834



FRY-TOP ELETTRICO LISCIO CROMATO SUPERCHROME (MOCA APPROVED), SU MOBILE A GIORNO, TOUCH SCREEN 4,3", TEMPERATURA 300°C CON CONTROLLO PID. "ENERGY SAVING, WIFI E CLOUD". FUNZIONI: 2 TIMER, SONDA AL CUORE PER COTTURE DIRETTE (OPTIONAL). PIASTRA CM.76X51 - 2 ZONE DI COTTURA (INCLUSA 1 TESTATA CHIUSURA PIANO MOD.TPA-7)

EN Electric Fry-top smooth chromed griddle SUPERCHROME (Moca Approved), on open cabinet, Touch Screen 4,3", temperature 300°C with PID control. "Energy Saving, WiFi and CLOUD". Functions: 2 timer, core probe for direct cooking (OPTIONAL). Plate cm.76x51 - 2 cooking areas (included 1 Head end filler strip mod. tpa-7)

DE Griddleplatte elektrische glatt hartverchromt SUPERCHROME (Moca Approved), mit offenem Unterbau, Touch Screen 4,3", Temperatur 300°C mit PID-Regelung. "Energy Saving, WiFi und CLOUD". Funktionen: 2 timer, Kerntemperaturfühler für direktes Garen (OPTIONAL). Platte cm.76x51 - 2 Heizzonen (inbegriffen 1 Abschluss-Element mod.tpa-7)

FR Plaque électriques lisse chromée SUPERCHROME (Moca Approved), sur armoire ouvert, Touch Screen 4,3", température 300°C avec contrôle PID. "Energy Saving, WiFi et CLOUD". Fonctions: 2 timer, sonde à cœur pour cuisson directe (OPTIONAL). Plaque cm.76x51 - 2 zones de cuisson (inclus 1 Élément de jonction top mod.tpa-7)

ES **FRY-TOP ELÉCTRICO LISO CROMADO SUPERCHROME (MOCA APPROVED), SOBRE MUEBLE ABIERTO, TOUCH SCREEN 4,3", TEMPERATURA 300°C CON CONTROL PID. "ENERGY SAVING, WIFI Y CLOUD". FUNCIONES: 2 TIMER, SONDA AL CORAZÓN PARA COCCIÓN DIRECTA (OPTIONAL). PLANCHA CM.76X51 - 2 ZONAS DE COCCIÓN (INCLUIDA 1 CHAPA DE CIERRE PARA TOP MOD.TPA-7)**

cm. 80 x 70,5 x 90h

cm. 83 x 77 x 111h / kg 110 / m³ 0,709

11,1 kW
400V~3N
230V~3
50/60 Hz

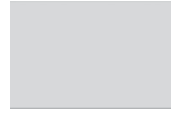
€ 5.910,00

FTLR-78ETTS

0806A835



FRY-TOP ELETTRICO 1/2 RIGATO + 1/2 LISCIO CROMATO SUPERCHROME (MOCA APPROVED), SU MOBILE A GIORNO, TOUCH SCREEN 4,3", TEMPERATURA 300°C CON CONTROLLO PID. "ENERGY SAVING, WIFI E CLOUD". FUNZIONI: 2 TIMER, SONDA AL CUORE PER COTTURE DIRETTE (OPTIONAL). PIASTRA CM.76X51 - 2 ZONE DI COTTURA (INCLUSA 1 TESTATA CHIUSURA PIANO MOD.TPA-7)

EN Electric Fry-top 1/2 grooved + 1/2 smooth chromed griddle SUPERCHROME (Moca Approved), on open cabinet, Touch Screen 4,3", temperature 300°C with PID control. "Energy Saving, WiFi and CLOUD". Functions: 2 timer, core probe for direct cooking (OPTIONAL). Plate cm.76x51 - 2 cooking areas (included 1 Head end filler strip mod.tpa-7)

DE Griddleplatte elektrische 1/2 gerillt + 1/2 glatt hartverchromt SUPERCHROME (Moca Approved), mit offenem Unterbau, Touch Screen 4,3", Temperatur 300°C mit PID-Regelung. "Energy Saving, WiFi und CLOUD". Funktionen: 2 timer, Kerntemperaturfühler für direktes Garen (OPTIONAL). Platte cm.76x51 - 2 Heizzonen (inbegriffen 1 Abschluss-Element mod.tpa-7)

FR Plaque électriques 1/2 nervurée + 1/2 lisse chromée SUPERCHROME (Moca Approved), sur armoire ouvert, Touch Screen 4,3", température 300°C avec contrôle PID. "Energy Saving, WiFi et CLOUD". Fonctions: 2 timer, sonde à cœur pour cuisson directe (OPTIONAL). Plaque cm.76x51 - 2 zones de cuisson (inclus 1 Élément de jonction top mod.tpa-7)

ES **FRY-TOP ELÉCTRICO 1/2 ESTRIADO + 1/2 LISO CROMADO SUPERCHROME (MOCA APPROVED), SOBRE MUEBLE ABIERTO, TOUCH SCREEN 4,3", TEMPERATURA 300°C CON CONTROL PID. "ENERGY SAVING, WIFI Y CLOUD". FUNCIONES: 2 TIMER, SONDA AL CORAZÓN PARA COCCIÓN DIRECTA (OPTIONAL). PLANCHA CM.76X51 - 2 ZONAS DE COCCIÓN (INCLUIDA 1 CHAPA DE CIERRE PARA TOP MOD.TPA-7)**

cm. 80 x 70,5 x 90h

cm. 83 x 77 x 111h / kg 110 / m³ 0,709

11,1 kW
400V~3N
230V~3
50/60 Hz

€ 6.085,00

FTL-712ETTS3

0806B23E



FRY-TOP ELETTRICO LISCIO CROMATO SUPERCHROME (MOCA APPROVED), SU MOBILE A GIORNO, TOUCH SCREEN 4,3", TEMPERATURA 300°C CON CONTROLLO PID. "ENERGY SAVING, WIFI E CLOUD". FUNZIONI: 2 TIMER, SONDA AL CUORE PER COTTURE DIRETTE (OPTIONAL). PIASTRA CM.116X51 - 3 ZONE DI COTTURA (INCLUSA 1 TESTATA CHIUSURA PIANO MOD.TPA-7)

EN Electric Fry-top smooth chromed griddle SUPERCHROME (Moca Approved), on open cabinet, Touch Screen 4,3", temperature 300°C with PID control. "Energy Saving, WiFi and CLOUD". Functions: 2 timer, core probe for direct cooking (OPTIONAL). Plate cm.116x51 - 3 cooking areas (included 1 Head end filler strip mod.tpa-7)

DE Griddleplatte elektrische glatt hartverchromt SUPERCHROME (Moca Approved), mit offenem Unterbau, Touch Screen 4,3", Temperatur 300°C mit PID-Regelung. "Energy Saving, WiFi und CLOUD". Funktionen: 2 timer, Kerntemperaturfühler für direktes Garen (OPTIONAL). Platte cm.116x51 - 3 Heizzonen (inbegriffen 1 Abschluss-Element mod.tpa-7)

FR Plaque électriques lisse chromée SUPERCHROME (Moca Approved), sur armoire ouvert, Touch Screen 4,3", température 300°C avec contrôle PID. "Energy Saving, WiFi et CLOUD". Fonctions: 2 timer, sonde à cœur pour cuisson directe (OPTIONAL). Plaque cm.116x51 - 3 zones de cuisson (inclus 1 Élément de jonction top mod.tpa-7)

ES **FRY-TOP ELÉCTRICO LISO CROMADO SUPERCHROME (MOCA APPROVED), SOBRE MUEBLE ABIERTO, TOUCH SCREEN 4,3", TEMPERATURA 300°C CON CONTROL PID. "ENERGY SAVING, WIFI Y CLOUD". FUNCIONES: 2 TIMER, SONDA AL CORAZÓN PARA COCCIÓN DIRECTA (OPTIONAL). PLANCHA CM.116X51 - 3 ZONAS DE COCCIÓN (INCLUIDA 1 CHAPA DE CIERRE PARA TOP MOD.TPA-7)**

cm. 120 x 70,5 x 90h

cm. 123 x 77 x 111h / kg 150 / m³ 1,051

16,65 kW
400V~3N
50/60 Hz

€ 8.921,00**FTLR-712ETTS3**

0806B23F



FRY-TOP ELETTRICO 1/3 RIGATO + 2/3 LISCIO CROMATO SUPERCHROME (MOCA APPROVED), SU MOBILE A GIORNO, TOUCH SCREEN 4,3", TEMPERATURA 300°C CON CONTROLLO PID. "ENERGY SAVING, WIFI E CLOUD". FUNZIONI: 2 TIMER, SONDA AL CUORE PER COTTURE DIRETTE (OPTIONAL). PIASTRA CM.116X51 - 3 ZONE DI COTTURA (INCLUSA 1 TESTATA CHIUSURA PIANO MOD.TPA-7)

EN Electric Fry-top 1/3 grooved + 2/3 smooth chromed griddle SUPERCHROME (Moca Approved), on open cabinet, Touch Screen 4,3", temperature 300°C with PID control. "Energy Saving, WiFi and CLOUD". Functions: 2 timer, core probe for direct cooking (OPTIONAL). Plate cm.116x51 - 3 cooking areas (included 1 Head end filler strip mod.tpa-7)

DE Griddleplatte elektrische 1/3 gerillt + 2/3 glatt hartverchromt SUPERCHROME (Moca Approved), mit offenem Unterbau, Touch Screen 4,3", Temperatur 300°C mit PID-Regelung. "Energy Saving, WiFi und CLOUD". Funktionen: 2 timer, Kerntemperaturfühler für direktes Garen (OPTIONAL). Platte cm.116x51 - 3 Heizzonen (inbegriffen 1 Abschluss-Element mod.tpa-7)

FR Plaque électriques 1/3 nervurée + 2/3 lisse chromée SUPERCHROME (Moca Approved), sur armoire ouvert, Touch Screen 4,3", température 300°C avec contrôle PID. "Energy Saving, WiFi et CLOUD". Fonctions: 2 timer, sonde à cœur pour cuisson directe (OPTIONAL). Plaque cm.116x51 - 3 zones de cuisson (inclus 1 Élément de jonction top mod.tpa-7)

ES **FRY-TOP ELÉCTRICO 1/3 ESTRIADO + 2/3 LISO CROMADO SUPERCHROME (MOCA APPROVED), SOBRE MUEBLE ABIERTO, TOUCH SCREEN 4,3", TEMPERATURA 300°C CON CONTROL PID. "ENERGY SAVING, WIFI Y CLOUD". FUNCIONES: 2 TIMER, SONDA AL CORAZÓN PARA COCCIÓN DIRECTA (OPTIONAL). PLANCHA CM.116X51 - 3 ZONAS DE COCCIÓN (INCLUIDA 1 CHAPA DE CIERRE PARA TOP MOD.TPA-7)**

cm. 120 x 70,5 x 90h

cm. 123 x 77 x 111h / kg 150 / m³ 1,051

16,65 kW
400V~3N
50/60 Hz

€ 9.062,00

GRIGLIE ELETTRICHE - TOUCH
EN ELECTRIC GRILL - TOUCH DE ELEKTRO-WURSTBRATER - TOUCH FR CHARCOAL ÉLECTRIQUE - TOUCH ES BARBACOAS ELECTRICAS - TOUCH
CWK-74ETT
 0808A431

GRIGLIA CONTACT SU MOBILE A GIORNO. TOUCH SCREEN 4,3", CON 10 LIVELLI DI POTENZA. "ENERGY SAVING, WIFI E CLOUD". FUNZIONI: 2 TIMER, SONDA AL CUORE PER COTTURE DIRETTE (OPTIONAL). COTTURA DIRETTA SU RESISTENZA IN ACCIAIO INOX CM. 27X43 RIBALTABILE (INCLUSA 1 TESTATA CHIUSURA PIANO MOD.TPA-7)

4,08 KW
 400V~3N
 50/60 Hz

€ 4.046,00

EN CONTACT Grill threephase on open cabinet. Touch Screen 4,3", with 10 power levels. "Energy Saving, WiFi and CLOUD". Functions: 2 timer, core probe for direct cooking (OPTIONAL). rotatable stainless steel grill cm. 27x43 (included 1 Head end filler strip mod.tpa-7)

DE Wurstbrater dreiphasig KONTAKT mit offenem Unterbau. Touch Screen 4,3", with 10 power levels. "Energy Saving, WiFi und CLOUD". Funktionen: 2 timer, Kerntemperaturfühler für direktes Garen (OPTIONAL). Drehbaren Heizelement aus Edelstahl cm. 27x43 (inbegriffen 1 Abschluss-Element mod.tpa-7)

FR Grillade triphase CONTACT sur armoire ouvert. Touch Screen 4,3", avec 10 niveaux de puissance. "Energy Saving, WiFi et CLOUD". Fonctions: 2 timer, sonde à cœur pour cuisson directe (OPTIONAL). Grille inox rotatif cm 27x43 (inclus 1 Élément de jonction top mod.tpa-7)

ES PARRILLA TRIFÁSICO CONTACT SOBRE MUEBLE ABIERTO. TOUCH SCREEN 4,3", CON 10 NIVELES DE POTENCIA. "ENERGY SAVING, WIFI Y CLOUD". FUNCIONES: 2 TIMER, SONDA AL CORAZÓN PARA COCCIÓN DIRECTA (OPTIONAL). PARRILLA GIRATORIA DE ACERO INOX CM 27X43 (INCLUIDA 1 CHAPA DE CIERRE PARA TOP MOD.TPA-7)

cm. 40 x 70,5 x 90h

cm. 43 x 77 x 111h / kg 60 / m³ 0,368

CWK-78ETT
 0808A831

GRIGLIA CONTACT SU MOBILE A GIORNO. TOUCH SCREEN 4,3", CON 10 LIVELLI DI POTENZA. "ENERGY SAVING, WIFI E CLOUD". FUNZIONI: 2 TIMER, SONDA AL CUORE PER COTTURE DIRETTE (OPTIONAL). COTTURA DIRETTA SU RESISTENZA IN ACCIAIO INOX CM. 55X43 RIBALTABILE - 2 ZONE DI COTTURA (INCLUSA 1 TESTATA CHIUSURA PIANO MOD.TPA-7)

8,16 KW
 400V~3N
 50/60 Hz

€ 6.782,00

EN CONTACT Grill threephase on open cabinet. Touch Screen 4,3", with 10 power levels. "Energy Saving, WiFi and CLOUD". Functions: 2 timer, core probe for direct cooking (OPTIONAL). rotatable stainless steel grill cm. 55x43 - 2 cooking areas (included 1 Head end filler strip mod.tpa-7)

DE Wurstbrater dreiphasig KONTAKT mit offenem Unterbau. Touch Screen 4,3", with 10 power levels. "Energy Saving, WiFi und CLOUD". Funktionen: 2 timer, Kerntemperaturfühler für direktes Garen (OPTIONAL). Drehbaren Heizelement aus Edelstahl cm. 55x43 - 2 Heizzonen (inbegriffen 1 Abschluss-Element mod.tpa-7)

FR Grillade triphase CONTACT sur armoire ouvert. Touch Screen 4,3", avec 10 niveaux de puissance. "Energy Saving, WiFi et CLOUD". Fonctions: 2 timer, sonde à cœur pour cuisson directe (OPTIONAL). Grille inox rotatif cm 55x43 - 2 zones de cuisson (inclus 1 Élément de jonction top mod.tpa-7)

ES PARRILLA TRIFÁSICO CONTACT SOBRE MUEBLE ABIERTO. TOUCH SCREEN 4,3", CON 10 NIVELES DE POTENCIA. "ENERGY SAVING, WIFI Y CLOUD". FUNCIONES: 2 TIMER, SONDA AL CORAZÓN PARA COCCIÓN DIRECTA (OPTIONAL). PARRILLA GIRATORIA DE ACERO INOX CM 55X43 - 2 ZONAS DE COCCIÓN (INCLUIDA 1 CHAPA DE CIERRE PARA TOP MOD. TPA-7)

cm. 80 x 70,5 x 90h

cm. 83 x 77 x 111h / kg 90 / m³ 0,709

FRIGGITRICI ELETTRICHE - TOUCH

EN ELECTRIC FRYERS - TOUCH DE ELEKTRO-FRITEUSE - TOUCH FR FRITEUSE ÉLECTRIQUE - TOUCH ES FREIDORAS ELECTRICAS - TOUCH

F2/8-74ETT
 0809A432

FRIGGITRICE TRIFASE LT. 8+8 2 VASCHE CM. 14,8X35X32,7H 2 CESTI CM. 12X30X15H. TOUCH SCREEN 4,3", TEMPERATURA MASSIMA 190°C CON CONTROLLO PID. "ENERGY SAVING, WIFI E CLOUD". FUNZIONI: 2 TIMER, MELTING. FILTRO E COPERCHIO VASCA. PRODUZIONE PATATE: 22 KG/H (INCLUSA 1 TESTATA CHIUSURA PIANO MOD.TPA-7)

EN Fryer threephase 8+8 lts - 2 Bowls cm. 14,8x35x32,7h - 2 baskets cm. 12x30x15h. Touch Screen 4,3", max temperature 190°C with PID control. "Energy Saving, WiFi and CLOUD". Functions: 2 timer, Melting. 2 sieve and lids for pan. 2 drip trays with sieves. Production: 22 kg/h (included 1 Head end filler strip mod.tpa-7)

DE Friteuse dreiphasig lt. 8+8 - 2 Becken cm. 14,8x35x32,7h - 2 Korb cm. 12x30x15h. Touch Screen 4,3", maximale Temperatur 190°C mit PID-Regelung. "Energy Saving, WiFi und CLOUD". Funktionen: 2 timer, Melting. 2 Einlegesieb und Deckel für Becken. 2 Fettauffangschalen mit Sieb. Pommes frites: 22 kg/h (inbegriffen 1 Abschluss-Element mod.tpa-7)

FR Friteuse triphase lt. 8+8 - 2 Cuve cm. 14,8x35x32,7h - 2 Panier cm. 12x30x15h. Touch Screen 4,3", température maximale 190°C avec contrôle PID. "Energy Saving, WiFi et CLOUD". Fonctions: 2 timer, Melting. 2 filtres, couvercles pour cuve. 2 bacs de récupération de l'huile avec filtre. Production de pommes frites: 22 kg/h (inclus 1 Élément de jonction top mod.tpa-7)

ES FREIDORAS TRIFÁSICO 8+8 LT. - 2 CUBA CM. 14,8X35X32,7H - 2 CESTA CM. 12X30X15HH. TOUCH SCREEN 4,3", TEMPERATURA MÁXIMA 190°C CON CONTROL PID. "ENERGY SAVING, WIFI Y CLOUD". FUNCIONES: 2 TIMER, MELTING. 2 FILTROS Y TAPAS PARA CUBAS. 2 BANDEJAS RECOGE ACEITE CON FILTRO. PROD. PATATAS: 22 KG/H (INCLUIDA 1 CHAPA DE CIERRE PARA TOP MOD.TPA-7)

cm. 40 x 70,5 x 90h

cm. 43 x 77 x 111h / kg 59 / m³ 0,368

12 kW
400V~3N
230V~3
50/60 Hz

€ 5.584,00

F13-74ETT
 0809A430

FRIGGITRICE TRIFASE LT. 13 VASCA CM. 24X35X33H 1 CESTO CM. 21X30X12H. TOUCH SCREEN 4,3", TEMPERATURA MASSIMA 190°C CON CONTROLLO PID. "ENERGY SAVING, WIFI E CLOUD". FUNZIONI: 2 TIMER, MELTING. FILTRO E COPERCHIO VASCA - PROD. PATATE: 15 KG/H (INCLUSA 1 TESTATA CHIUSURA PIANO MOD.TPA-7)

EN Fryer threephase 13 lts. - Bowl cm. 24x35x33h 1 basket cm. 21x30x12h. Touch Screen 4,3", max temperature 190°C with PID control. "Energy Saving, WiFi and CLOUD". Functions: 2 timer, Melting. Sieve and lid for pan. Drip tray with sieve. Production: 15 kg/h (included 1 Head end filler strip mod.tpa-7)

DE Friteuse dreiphasig lt. 13 - Becken cm. 24x35x33h 1 Korb cm. 21x30x12h. Touch Screen 4,3", maximale Temperatur 190°C mit PID-Regelung. "Energy Saving, WiFi und CLOUD". Funktionen: 2 timer, Melting. Einlegesieb und Deckel für Becken. Fettauffangschale mit Sieb. Pommes frites: 15 kg/h (inbegriffen 1 Abschluss-Element mod.tpa-7)

FR Friteuse triphase lt. 13 - Cuve cm. 24x35x33h 1 Panier cm. 21x30x12h. Touch Screen 4,3", température maximale 190°C avec contrôle PID. "Energy Saving, WiFi et CLOUD". Fonctions: 2 timer, Melting. Filtre, couvercle pour cuve. Bac de récupération de l'huile avec filtre. Production de pommes frites: 15 kg/h (inclus 1 Élément de jonction top mod.tpa-7)

ES FREIDORAS TRIFÁSICO 13 LT. - CUBA CM. 24X35X33H 1 CESTA CM. 21X30X12H. TOUCH SCREEN 4,3", TEMPERATURA MÁXIMA 190°C CON CONTROL PID. "ENERGY SAVING, WIFI Y CLOUD". FUNCIONES: 2 TIMER, MELTING. FILTRO Y TAPA PARA CUBA. BANDEJA RECOGE ACEITE CON FILTRO. PRODUCCIÓN PATATAS: 15 KG/H (INCLUIDA 1 CHAPA DE CIERRE PARA TOP MOD.TPA-7)

cm. 40 x 70,5 x 90h

cm. 43 x 77 x 111h / kg 54 / m³ 0,368

10,95 kW
400V~3N
50/60 Hz

€ 3.523,00

F18-74ETT

0809A431



FRIGGITRICE TRIFASE LT. 18 VASCA CM. 31X34X33H 1 CESTO CM. 28X29X15H. TOUCH SCREEN 4,3", TEMPERATURA MASSIMA 190°C CON CONTROLLO PID. "ENERGY SAVING, WIFI E CLOUD". FUNZIONI: 2 TIMER, MELTING. FILTRO E COPERCHIO VASCA - PROD. PATATE: 23 KG/H (INCLUSA 1 TESTATA CHIUSURA PIANO MOD.TPA-7)

- EN** Fryer threephase 18 lts. - Bowl cm. 31x34x33h 1 basket cm. 28x29x15h. Touch Screen 4,3", max temperature 190°C with PID control. "Energy Saving, WiFi and CLOUD". Functions: 2 timer, Melting. Sieve and lid for pan. Drip tray with sieve. Production: 23 kg/h (included 1 Head end filler strip mod.tpa-7)
- DE** Friteuse dreiphasig lt. 18 - Becken cm. 31x34x33h 1 Korb cm. 28x29x15h. Touch Screen 4,3", maximale Temperatur 190°C mit PID-Regelung. "Energy Saving, WiFi und CLOUD". Funktionen: 2 timer, Melting. Einlegesieb und Deckel für Becken. Fettauffangschale mit Sieb. Pommes frites: 23 kg/h (inbegriffen 1 Abschluss-Element mod.tpa-7)
- FR** Friteuse triphase lt. 18 - Cuve cm. 31x34x33h 1 Panier cm. 28x29x15h. Touch Screen 4,3", température maximale 190°C avec contrôle PID. "Energy Saving, WiFi et CLOUD". Fonctions: 2 timer, Melting. Filtre, couvercle pour cuve. Bac de récupération de l'huile avec filtre. Production de pommes frites: 23 kg/h (inclus 1 Élément de jonction top mod.tpa-7)
- ES** FREIDORAS TRIFÁSICO 18 LT. - CUBA CM. 31X34X33H 1 CESTA CM. 28X29X15H. TOUCH SCREEN 4,3", TEMPERATURA MÁXIMA 190°C CON CONTROL PID. "ENERGY SAVING, WIFI Y CLOUD". FUNCIONES: 2 TIMER, MELTING. FILTRO Y TAPA PARA CUBA. BANDEJA RECOGE ACEITE CON FILTRO. PRODUCCIÓN PATATAS: 23 KG/H (INCLUIDA 1 CHAPA DE CIERRE PARA TOP MOD.TPA-7)

15,9 kW
400V~3N
50/60 Hz

€ 3.700,00

- cm. 40 x 70,5 x 90h
- cm. 43 x 77 x 111h / kg 57 / m³ 0,368

F2/13-78ETT

0809A830



FRIGGITRICE TRIFASE LT. 13+13 2 VASCHE CM. 24X35X33H - 2 CESTI CM. 21X30X12H. TOUCH SCREEN 4,3", TEMPERATURA MASSIMA 190°C CON CONTROLLO PID. "ENERGY SAVING, WIFI E CLOUD". FUNZIONI: 2 TIMER, MELTING. 2X FILTRO E COPERCHIO VASCA - PROD. PATATE: 30 KG/H (INCLUSA 1 TESTATA CHIUSURA PIANO MOD.TPA-7)

- EN** Fryer threephase 13+13 lts - 2 Bowls cm. 24x35x33h 2 baskets cm. 21x30x12h. Touch Screen 4,3", max temperature 190°C with PID control. "Energy Saving, WiFi and CLOUD". Functions: 2 timer, Melting. 2 sieve and lids for pan. 2 drip trays with sieves. Production: 30 kg/h (included 1 Head end filler strip mod.tpa-7)
- DE** Friteuse dreiphasig lt. 13+13 - 2 Becken cm. 24x35x33h 2 Körbe cm. 21x30x12h. Touch Screen 4,3", maximale Temperatur 190°C mit PID-Regelung. "Energy Saving, WiFi und CLOUD". Funktionen: 2 timer, Melting. 2 Einlegesieb und Deckel für Becken. 2 Fettauffangschalen mit Sieb. Pommes frites: 30 kg/h (inbegriffen 1 Abschluss-Element mod.tpa-7)
- FR** Friteuse triphase lt. 13+13 - 2 cuves cm. 24x35x33h 2 paniers cm. 21x30x12h. Touch Screen 4,3", température maximale 190°C avec contrôle PID. "Energy Saving, WiFi et CLOUD". Fonctions: 2 timer, Melting. 2 filtres, couvercles pour cuve. 2 bacs de récupération de l'huile avec filtre. Production de pommes frites: 30 kg/h (inclus 1 Élément de jonction top mod.tpa-7)
- ES** FREIDORAS TRIFÁSICO 13+13 LT. - 2 CUBAS CM. 24X35X33H 2 CESTAS CM. 21X30X12H. TOUCH SCREEN 4,3", TEMPERATURA MÁXIMA 190°C CON CONTROL PID. "ENERGY SAVING, WIFI Y CLOUD". FUNCIONES: 2 TIMER, MELTING. 2 FILTROS Y TAPAS PARA CUBAS. 2 BANDEJAS RECOGE ACEITE CON FILTRO. PRODUCCIÓN PATATAS: 30 KG/H (INCLUIDA 1 CHAPA DE CIERRE PARA TOP MOD.TPA-7)

21,9 kW
400V~3N
50/60 Hz

€ 6.071,00

- cm. 80 x 70,5 x 90h
- cm. 83 x 77 x 111h / kg 95 / m³ 0,709

F2/18-78ETT

0809A831



FRIGGITRICE TRIFASE LT. 18+18 2 VASCHE CM. 31X34X33H - 2 CESTI CM. 28X29X15H. TOUCH SCREEN 4,3", TEMPERATURA MASSIMA 190°C CON CONTROLLO PID. "ENERGY SAVING, WIFI E CLOUD". FUNZIONI: 2 TIMER, MELTING. 2X FILTRO E COPERCHIO VASCA - PROD. PATATE: 46 KG/H (INCLUSA 1 TESTATA CHIUSURA PIANO MOD.TPA-7)

EN Fryer threephase 18+18 lts - 2 BOWLS cm. 31x34x33h 2 baskets cm. 28x29x15h. Touch Screen 4,3", max temperature 190°C with PID control. "Energy Saving, WiFi and CLOUD". Functions: 2 timer, Melting. 2 sieve and lids for pan. 2 drip trays with sieves. Production: 46 kg/h (included 1 Head end filler strip mod.tpa-7)

DE Friteuse dreiphasig lt. 18+18 - 2 Becken cm. 31x34x33h 2 Körbe cm. 28x29x15h. Touch Screen 4,3", maximale Temperatur 190°C mit PID-Regelung. "Energy Saving, WiFi und CLOUD". Funktionen: 2 timer, Melting. 2 Einlegesieb und Deckel für Becken. 2 Fettauffangschalen mit Sieb. Pommes frites: 46 kg/h (inbegriffen 1 Abschluss-Element mod.tpa-7)

FR Friteuse triphase lt. 18+18 - 2 cuves cm. 31x34x33h 2 paniers cm. 28x29x15h. Touch Screen 4,3", température maximale 190°C avec contrôle PID. "Energy Saving, WiFi et CLOUD". Fonctions: 2 timer, Melting. 2 filtres, couvercles pour cuve. 2 bacs de récupération de l'huile avec filtre. Production de pommes frites: 46 kg/h (inclus 1 Élément de jonction top mod.tpa-7)

ES FREIDORAS TRIFÁSICO 18+18 LT. - 2 CUBAS CM. 31X34X33H 2 CESTAS CM. 28X29X15H. TOUCH SCREEN 4,3", TEMPERATURA MÁXIMA 190°C CON CONTROL PID. "ENERGY SAVING, WIFI Y CLOUD". FUNCIONES: 2 TIMER, MELTING. 2 FILTROS Y TAPAS PARA CUBAS. 2 BANDEJAS RECOGE ACEITE CON FILTRO. PRODUCCIÓN PATATAS: 46 KG/H (INCLUIDA 1 CHAPA DE CIERRE PARA TOP MOD.TPA-7)

cm. 80 x 70,5 x 90h

cm. 83 x 77 x 111h / kg 97 / m³ 0,709

€ 6.434,00
 ⚡ 31,8 kW
 400V~3N
 50/60 Hz

F45-78ETT

0809A835



FRIGGITRICE TRIFASE LT. 45 VASCA CM. 70X38X38H 1 CESTO CM. 65X33X17H. TOUCH SCREEN 4,3", TEMPERATURA MASSIMA 190°C CON CONTROLLO PID. "ENERGY SAVING, WIFI E CLOUD". FUNZIONI: 2 TIMER, MELTING. FILTRO E COPERCHIO VASCA - PROD. PATATE: 48 KG/H (INCLUSA 1 TESTATA CHIUSURA PIANO MOD.TPA-7)

EN Fryer threephase 45 lts. - Bowl cm. 70x38x38h 1 basket cm. 65x33x17h. Touch Screen 4,3", max temperature 190°C with PID control. "Energy Saving, WiFi and CLOUD". Functions: 2 timer, Melting. Sieve and lid for pan. Drip tray with sieve. Production: 48 kg/h (included 1 Head end filler strip mod.tpa-7)

DE Friteuse dreiphasig lt. 45 - Becken cm. 70x38x38h 1 Korb cm. 65x33x17h. Touch Screen 4,3", maximale Temperatur 190°C mit PID-Regelung. "Energy Saving, WiFi und CLOUD". Funktionen: 2 timer, Melting. Einlegesieb und Deckel für Becken. Fettauffangschale mit Sieb. Pommes frites: 48 kg/h (inbegriffen 1 Abschluss-Element mod.tpa-7)

FR Friteuse triphase lt. 45 - Cuve cm. 70x38x38h 1 Panier cm. 65x33x17h. Touch Screen 4,3", température maximale 190°C avec contrôle PID. "Energy Saving, WiFi et CLOUD". Fonctions: 2 timer, Melting. Filtre, couvercle pour cuve. Bac de récupération de l'huile avec filtre. Production de pommes frites: 48 kg/h (inclus 1 Élément de jonction top mod.tpa-7)

ES FREIDORAS TRIFÁSICO 45 LT. - CUBA CM. 70X38X38H 1 CESTA CM. 65X33X17H. TOUCH SCREEN 4,3", TEMPERATURA MÁXIMA 190°C CON CONTROL PID. "ENERGY SAVING, WIFI Y CLOUD". FUNCIONES: 2 TIMER, MELTING. FILTRO Y TAPA PARA CUBA. BANDEJA RECOGE ACEITE CON FILTRO. PRODUCCIÓN PATATAS: 48 KG/H (INCLUIDA 1 CHAPA DE CIERRE PARA TOP MOD.TPA-7)

cm. 80 x 70,5 x 90h

cm. 83 x 77 x 111h / kg 96 / m³ 0,709

€ 6.066,00
 ⚡ 40 kW
 400V~3N
 50/60 Hz

BRASIERE FISSE MULTIFUNZIONE ELETTRICHE - TOUCH

EN FIXED ELECTRIC BRATT PANS - TOUCH **DE** ELEKTRO MULTIFUNKTIONSBRATPFANNE FEST - TOUCH **FR** SAUTEUSE FIXE ELÉCTRIQUE - TOUCH
ES SARTEN FIJA ELECTRICA - TOUCH

BRF-74ETT
 0807A433



BRASIERA FISSA MULTIFUNZIONALE ELETTRICA VASCA CM. 32,5X46X10H. TOUCH SCREEN 4,3", TEMPERATURA 300°C CON CONTROLLO PID. "ENERGY SAVING, WIFI E CLOUD". FUNZIONI: 2 TIMER, SONDA AL CUORE PER COTTURE DIRETTE (OPTIONAL). (INCLUSA 1 TESTATA CHIUSURA PIANO MOD.TPA-7)

EN Electric multi-function fixed braising pan Bowl cm. 32,5x46x10h. Touch Screen 4,3", temperature 300°C with PID control. "Energy Saving, WiFi and CLOUD". Functions: 2 timer, core probe for direct cooking (OPTIONAL). (included 1 Head end filler strip mod.tpa-7)

DE Elektrische Multifunktionsbratpfanne fest Becken cm. 32,5x46x10h. Touch Screen 4,3", Temperatur 300°C mit PID-Regelung. "Energy Saving, WiFi und CLOUD". Funktionen: 2 timer, Kerntemperaturfühler für direktes Garen (OPTIONAL). (inbegriffen 1 Abschluss-Element mod.tpa-7)

FR Sauteuse fixe multifonction électrique Cuve cm. 32,5x46x10h. Touch Screen 4,3", température 300°C avec contrôle PID. "Energy Saving, WiFi et CLOUD". Fonctions: 2 timer, sonde à cœur pour cuisson directe (OPTIONAL). (inclus 1 Élément de jonction top mod.tpa-7)

ES SARTEN FIJA MULTIFUNCIÓN ELÉCTRICA CUBA CM. 32,5X46X10H. TOUCH SCREEN 4,3", TEMPERATURA 300°C CON CONTROL PID. "ENERGY SAVING, WIFI Y CLOUD". FUNCIONES: 2 TIMER, SONDA AL CORAZÓN PARA COCCIÓN DIRECTA (OPTIONAL). (INCLUIDA 1 CHAPA DE CIERRE PARA TOP MOD.TPA-7)

cm. 40 x 70,5 x 90h

cm. 43 x 77 x 111h / kg 79 / m³ 0,368

4,5 kW
 400V~3N
 230V~3
 50/60 Hz

€ 5.172,00

BRF-78ETT
 0807A833



BRASIERA FISSA MULTIFUNZIONALE ELETTRICA VASCA CM. 72,5X46X10H, 2 ZONE DI COTTURA. TOUCH SCREEN 4,3", TEMPERATURA 300°C CON CONTROLLO PID. "ENERGY SAVING, WIFI E CLOUD". FUNZIONI: 2 TIMER, SONDA AL CUORE PER COTTURE DIRETTE (OPTIONAL). (INCLUSA 1 TESTATA CHIUSURA PIANO MOD.TPA-7)

EN Electric multi-function fixed braising pan Bowl cm. 72,5x46x10h, 2 cooking areas. Touch Screen 4,3", temperature 300°C with PID control. "Energy Saving, WiFi and CLOUD". Functions: 2 timer, core probe for direct cooking (OPTIONAL). (included 1 Head end filler strip mod.tpa-7)

DE Elektrische Multifunktionsbratpfanne fest Becken cm. 72,5x46x10h, 2 Heizzonen. Touch Screen 4,3", Temperatur 300°C mit PID-Regelung. "Energy Saving, WiFi und CLOUD". Funktionen: 2 timer, Kerntemperaturfühler für direktes Garen (OPTIONAL). (inbegriffen 1 Abschluss-Element mod.tpa-7)

FR Sauteuse fixe multifonction électrique Cuve cm. 72,5x46x10h, 2 zones de cuisson. Touch Screen 4,3", température 300°C avec contrôle PID. "Energy Saving, WiFi et CLOUD". Fonctions: 2 timer, sonde à cœur pour cuisson directe (OPTIONAL). (inclus 1 Élément de jonction top mod.tpa-7)

ES SARTEN FIJA MULTIFUNCIÓN ELÉCTRICA CUBA CM. 72,5X46X10H, 2 ZONAS DE COCCIÓN. TOUCH SCREEN 4,3", TEMPERATURA 300°C CON CONTROL PID. "ENERGY SAVING, WIFI Y CLOUD". FUNCIONES: 2 TIMER, SONDA AL CORAZÓN PARA COCCIÓN DIRECTA (OPTIONAL). (INCLUIDA 1 CHAPA DE CIERRE PARA TOP MOD.TPA-7)

cm. 80 x 70,5 x 90h

cm. 83 x 77 x 111h / kg 126 / m³ 0,709

9 kW
 400V~3N
 230V~3
 50/60 Hz

€ 8.442,00

BRASIERE RIBALTABILI ELETTRICHE - TOUCH

EN ELECTRIC TILTING BRATTPANS - TOUCH DE ELEKTRO KIPPEN BRATPFANNEN - TOUCH FR SAUTEUSE BASCULANTE ÉLECTRIQUE - TOUCH
 ES SARTEN BASCULANTES ELECTRICO - TOUCH

BRM50-78ETT
0813A831

BRASIERA CON VASCA RIBALTABILE MOTORIZZATA, VASCA INOX 50 LITRI CM.71X37X18,5H, COPERCHIO DOPPIA PARETE. TOUCH SCREEN 4,3", TEMPERATURA MASSIMA 300°C CON CONTROLLO PID. "ENERGY SAVING, WIFI E CLOUD". FUNZIONI: 2 TIMER, CARICO ACQUA, SONDA AL CUORE PER COTTURE DIRETTE (OPTIONAL).

EN Braising pan with motorized tank, inox bowl 50 lt. cm.71x37x18,5h, double wall lid. Touch Screen 4,3", max temperature 300°C with PID control. "Energy Saving, WiFi and CLOUD". Functions: 2 timer, water loading, core probe for direct cooking (OPTIONAL).

DE Kippbratpfanne mit motorisiertem Tank, Edelstahlschale 50 Lt. cm.71x37x18,5h, Doppelwanddeckel. Touch Screen 4,3", maximale Temperatur 300°C mit PID-Regelung. "Energy Saving, WiFi und CLOUD". Funktionen: 2 timer, Wasserbeladung, Kerntemperaturfühler für direktes Garen (OPTIONAL).

FR Sauteuse avec cuve basculement motorisé, cuve inox 50 lt. cm.71x37x18,5h, couvercle à double paroi. Touch Screen 4,3", température maximale 300°C avec contrôle PID. "Energy Saving, WiFi et CLOUD". Fonctions: 2 timer, chargement d'eau, sonde à cœur pour cuisson directe (OPTIONAL).

ES SARTÉN CON CUBA BASCULANTE MOTORIZADA, CUBA DE ACERO INOX 50 LT. CM.71X37X18,5H, TAPA DE DOBLE PARED. TOUCH SCREEN 4,3", TEMPERATURA MÁXIMA 300°C CON CONTROL PID. "ENERGY SAVING, WIFI Y CLOUD". FUNCIONES: 2 TIMER, CARGA AGUA, SONDA AL CORAZÓN PARA COCCIÓN DIRECTA (OPTIONAL).

cm. 80 x 70,5 x 90h

cm. 83 x 77 x 111h / kg 135 / m³ 0,709

10,5 kW
400V~3N
50/60 Hz

€ 9.883,00

PENTOLE ELETTRICHE - TOUCH

EN ELECTRIC KETTLE - TOUCH DE ELEKTRO-KOCHKESSEL - TOUCH FR MARMITES ÉLECTRIQUE - TOUCH ES MARMITAS ELECTRICAS - TOUCH

PI50A-78ETT
0816A832

PENTOLA INDIRETTA ELETTRICA LT.50 VASCA Ø CM. 40X48H. TOUCH SCREEN 4,3", CON 10 LIVELLI DI POTENZA. "ENERGY SAVING, WIFI E CLOUD". FUNZIONI: 2 TIMER, CARICO ACQUA CALDA E FREDDA, SONDA AL CUORE (OPTIONAL). CARICO AUTOMATICO INTERCAPEDINE (INCLUSA 1 TESTATA CHIUSURA PIANO MOD.TPA-7)

EN Electric indirect boiling pan 50 lts. Tank Ø cm. 40x48h. Touch Screen 4,3", with 10 power levels. "Energy Saving, WiFi and CLOUD". Functions: 2 timer, water loading cold and hot, core probe (OPTIONAL). Automatic water-charge of double jacket (included 1 Head end filler strip mod.tpa-7)

DE Indirekter Elektro-Kochkessel lt. 50 Becken Ø cm. 40x48h. Touch Screen 4,3", with 10 power levels. "Energy Saving, WiFi und CLOUD". Funktionen: 2 timer, Wasserbeladung kalt und heiß, Kernsonde (OPTIONAL). Automatische Wasserstandskontrolle im Zwischenmantel (inbegriffen 1 Abschluss-Element mod. tpa-7)

FR Marmite indirecte électrique lt. 50 Cuve Ø cm. 40x48h. Touch Screen 4,3", avec 10 niveaux de puissance. "Energy Saving, WiFi et CLOUD". Fonctions: 2 timer, chargement d'eau froid et chaud, sonde à cœur (OPTIONAL). Remplissage automatique dans la double paroi (inclus 1 Élément de jonction top mod.tpa-7)

ES MARMITA DE CALEFACCIÓN INDIRECTA 50 LT. CUBA Ø CM. 40X48H. TOUCH SCREEN 4,3", CON 10 NIVELES DE POTENCIA. "ENERGY SAVING, WIFI Y CLOUD". FUNCIONES: 2 TIMER, CARGA AGUA FRIA Y CALIENTE, SONDA AL CORAZÓN (OPTIONAL). CARGA AUTOMÁTICA DE LA CAMISA INTERCAMBIADOR (INCLUIDA 1 CHAPA DE CIERRE PARA TOP MOD.TPA-7)

cm. 80 x 70,5 x 90h

cm. 83 x 77 x 111h / kg 120 / m³ 0,709

10,2 kW
400V~3N
50/60 Hz

€ 10.964,00

ACCESSORI - TOUCH

EN ACCESSORIES - TOUCH DE ZUBEHÖR - TOUCH FR ACCESSOIRES - TOUCH ES ACCESORIOS - TOUCH

SCSV-ST
 0958A000

SONDA AL CUORE CON SPILLONE Ø1,5MM PER COTTURE SOTTOVUOTO SU "CPA" E "PI" TOUCH

EN Core probe Ø1,5mm for sous vide cooking on "CPA" and "PI" touch
 DE Kerntemperaturfühler Ø1,5mm für Sous-Vide-Garen auf "CPA" und "PI" touch
 FR Sonde à cœur Ø1,5mm pour cuisson sous vide sur "CPA" et "PI" touch
 ES **SONDA AL CORAZÓN Ø1,5MM PARA COCCIÓN AL VACÍO EN "CPA" Y "PI" TOUCH**

 cm. 25 x 15 x 5h / kg 0.2 / m³ 0,002

€ 233,00

SCCD-ST
 0958A001

SONDA AL CUORE CON SPILLONE Ø4MM PER COTTURE DIRETTE SU "FT" E "BRF" E "CWK" E "BRM" TOUCH

EN Core probe Ø4mm for direct cooking on "FT" and "BRF" and "CWK" and "BRM" touch
 DE Kerntemperaturfühler Ø4mm für direktes Garen auf "FT" und "BRF" und "CWK" und "BRM" touch
 FR Sonde à cœur Ø4mm pour cuisson directe sur "FT" et "BRF" et "CWK" et "BRM" touch
 ES **SONDA AL CORAZÓN Ø4MM PARA COCCIÓN DIRECTA EN "FT" Y "BRF" Y "CWK" Y "BRM" TOUCH**

 cm. 25 x 15 x 5h / kg 0.2 / m³ 0,002

€ 233,00

SPSC-PI
 0958A002

SUPPORTO PER SONDA AL CUORE NECESSARIO SU "PI" TOUCH

EN Support for core probe necessary on "PI" touch
 DE Unterstützung für Kernsonden notwendig auf "PI" touch
 FR Support pour sonde à cœur nécessaire sur "PI" touch
 ES **SOPORTE PARA SONDA AL CORAZÓN NECESARIO EN "PI" TOUCH**

 cm. 30 x 15 x 10h / kg 0.5 / m³ 0,005

€ 156,00

70 SUPERLOTUS ACC

ACCESSORI
EN ACCESSORIES DE ZUBEHÖR FR ACCESSOIRES ES ACCESORIOS
PT-POTS

STRUTTURA PORTATEGAMI PER S70 E S90 (REALIZZAZIONI A PROGETTO)

€ 1.512,00

EN pot rack structure for S70 / S90 (realizations for project)
DE Ablagerost für Kochwerkzeuge, für S70 / S90 (Realisierunge im Projekt)
FR structures porte casseroles pour S70 / S90 (réalisations en projet)
ES ESTRUCTURAS SUPERIORES PORTA CAZUELAS PARA S70 / S90 (LOGROS EN EL PROYECTO)

€ / m x cm. 70 x 75h

PT-POTS-SL



STRUTTURA PORTATEGAMI PER S70 E S90 CON ABBASSAMENTO PORTASALAMANDRA (REALIZZAZIONI A PROGETTO)

€ 1.620,00

EN pot rack structure for S70 / S90 with salamander support (realizations for project)
DE Ablagerost für Kochwerkzeuge, für S70 / S90 mit Salamander Konsolen (Realisierunge im Projekt)
FR structures porte casseroles pour S70 / S90 avec porte salamandres (réalisations en projet)
ES ESTRUCTURAS SUPERIORES PORTA CAZUELAS PARA S70 / S90 CON PORTA SALAMANDRA (LOGROS EN EL PROYECTO)

€ / m x cm. 70 x 75h

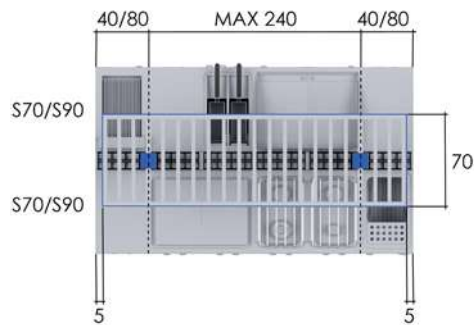
NO CM.20/30/60

P-73/93-DX

08430300



PORTA 300 DESTRA

€ 219,00

EN Right door 300
DE Rechte tür 300
FR Porte droite 300
ES PUERTA DERECHA 300

cm. 29,5 x 2,5 x 47,5h

 cm. 33 x 7 x 58h / kg 3 / m³ 0,013

P-74/94-DX

08430400

PORTA 400 DESTRA

€ 227,00

EN Right door 400
DE Rechte tür 400
FR Porte droite 400
ES PUERTA DERECHA 400

cm. 39,5 x 2,5 x 47,5h

 cm. 43 x 7 x 58h / kg 3.5 / m³ 0,017

P-73/93-SX

08430301



PORTA 300 SINISTRA

- EN** Left door 300
- DE** Linke tür 300
- FR** Porte gauche 300
- ES** **PUERTA IZQUIERDA 300**

cm. 29,5 x 2,5 x 47,5h

 cm. 33 x 7 x 58h / kg 3 / m³ 0,013
€ 219,00**P-74/94-SX**

08430401

PORTA 400 SINISTRA

- EN** Left door 400
- DE** Linke tür 400
- FR** Porte gauche 400
- ES** **PUERTA IZQUIERDA 400**

cm. 39,5 x 2,5 x 47,5h

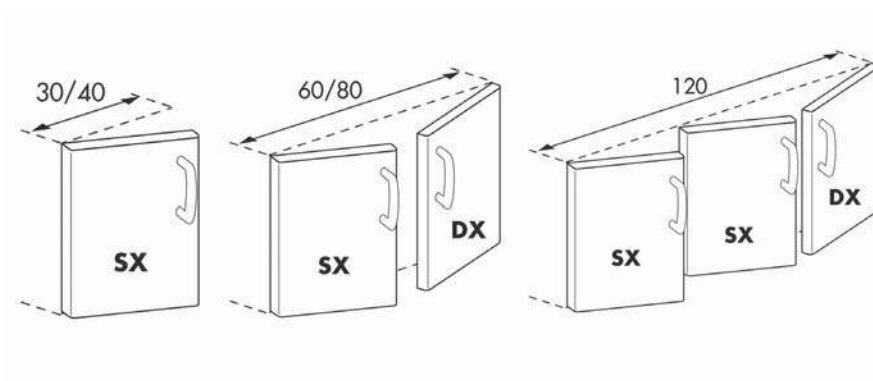
 cm. 43 x 7 x 58h / kg 3.5 / m³ 0,017
€ 227,00**C-73/93**

08440320



CASSETTIERA 300 - N. 2 CASSETTI CON 2 BACINELLE INOX, GUIDE TELESCOPICHE. SOLO SU PL

- EN** Drawer set 300 - N. 2 drawers with 2 inox containers, telescopic guides. Only for PL
- DE** Schubladen 300 - N. 2 Schubladen mit 2 Chromnickelstahlbehältern, Telescopeinführungen. Nur für PL
- FR** Tiroirs pour meuble de 300 - N. 2 tiroirs avec 2 bacs inox, guides télescopiques. Seulement pour PL

ES CAJONERA 300 - N. 2 CAJONES CON 2 CONTENEDORES DE ACERO INOX, GUÍAS TELESCÓPICAS. SOLO PARA PL

cm. 29,5 x 59 x 47,5h

 cm. 43 x 69 x 65h / kg 16 / m³ 0,193
€ 852,00**C-74/94**

08440420



CASSETTIERA 400 - N. 2 CASSETTI CON 2 BACINELLE GN 1/1 15H IN INOX, GUIDE TELESCOPICHE. SOLO SU PL

- EN** Drawer set 400 - N. 2 drawers with 2 GN 1/1 15h inox containers, telescopic guides. Only for PL
- DE** Schubladen - N. 2 Schubladen mit 2 GN 1/1 15h aus Edelstahl, Telescopeinführungen. Nur für PL
- FR** Tiroirs pour meuble de 400 - N. 2 tiroirs avec 2 bacs en inox GN 1/1 15h, guides télescopiques. Seulement pour PL

ES CAJONERA 400 - N. 2 CAJONES CON 2 CONTENEDORES GN 1/1 15H DE ACERO INOX, GUÍAS TELESCÓPICAS. SOLO PARA PL

cm. 39,5 x 59 x 47,5h

 cm. 43 x 69 x 65h / kg 18 / m³ 0,193
€ 875,00

C-76/96

08440620



CASSETTIERA 600 N. 2 CASSETTI CON 2 BACINELLE INOX, GUIDE TELESCOPICHE. SOLO SU PL

€ 1.209,00

- EN** Drawer set 600 N. 2 drawers with 2 inox containers, telescopic guides. Only for PL
- DE** Schubladen 600 - N. 2 Schubladen mit 2 Chromnickelstahlbehältern, Telescopeinführungen. Nur für PL
- FR** Tiroirs pour meuble de 600 N. 2 tiroirs avec 2 bacs inox, guides télescopiques. Seulement pour PL
- ES** **CAJONERA 600 - N. 2 CAJONES CON 2 CONTENEDORES DE ACERO INOX, GUÍAS TELESCÓPICAS. SOLO PARA PL**

- cm. 59,5 x 59 x 47,5h
- cm. 63 x 69 x 65h / kg 22 / m³ 0,283

C-78/98

08440820



CASSETTIERA 800 - N. 2 CASSETTI CON 4 BACINELLE GN 1/1 15H IN INOX, GUIDE TELESCOPICHE. SOLO SU PL

€ 1.229,00

- EN** Drawer set 800 - N. 2 drawers with 4 GN 1/1 15h inox containers, telescopic guides. Only for PL
- DE** Schubladen 800 - N. 2 Schubladen mit 4 GN 1/1 15h aus Edelstahl, Telescopeinführungen. Nur für PL
- FR** Tiroirs pour meuble de 800 - N. 2 tiroirs avec 4 bacs en inox GN 1/1 15h, guides télescopiques. Seulement pour PL
- ES** **CAJONERA 800 - N. 2 CAJONES CON 4 CONTENEDORES GN 1/1 15H DE DE ACERO INOX, GUÍAS TELESCÓPICAS. SOLO PARA PL**

- cm. 79,5 x 59 x 47,5h
- cm. 83 x 69 x 65h / kg 26 / m³ 0,372

D-7

08470000



DIVISORIO

€ 177,00

- EN** Spacer
- DE** Trennwand
- FR** Separation
- ES** **DIVISORIO**

- cm. 5 x 59 x 45h
- cm. 7 x 60 x 51h / kg 2.5 / m³ 0,021

R-74

08450400



RIPIANO 400

€ 140,00

- EN** Shelf 400
- DE** Zwischenboden 400
- FR** Etagère 400
- ES** **ESTANTE 400**

- cm. 35 x 59 x 3,5h
- cm. 37 x 61 x 4h / kg 2 / m³ 0,009

R-76

08450600



RIPIANO 600

€ 159,00

- EN** Shelf 600
- DE** Zwischenboden 600
- FR** Etagère 600
- ES** **ESTANTE 600**

- cm. 55 x 59 x 3,5h
- cm. 57 x 61 x 4h / kg 3 / m³ 0,014

R-78

08450800



RIPIANO 800

€ 177,00

- EN** Shelf 800
- DE** Zwischenboden 800
- FR** Etagère 800
- ES** **ESTANTE 800**

- cm. 75 x 59 x 3,5h
- cm. 77 x 61 x 4h / kg 3.5 / m³ 0,019

PT-74/94

08460002



PORTATEGLIE VANO 400/600 (GN-1/1) 4 RIPIANI INT. 7 CM.

- EN** Frame for plates 400/600 (GN-1/1) - N. 4 shelves, wheel-base 7 cm.
- DE** Auflangeschienen für bleche 400/600 (GN-1/1) N. 4 Etagen, Abstand 7 cm.
- FR** Kit porte-plaques 400/600 (GN-1/1) - N. 4 étagères; 7 cm.
- ES** **PORTACAZUELAS 400/600 (GN-1/1) - N. 4 ESTANTES, INT. 7 CM.**

€ 473,00

 cm. 5 x 60 x 32h / kg 2.5 / m³ 0,010
PT-78/98

08460012

PORTATEGLIE VANO 800 (GN-2/1) 4 RIPIANI INT. 7 CM.

- EN** Frame for plates 800 (GN-2/1) 4 Etagen, Abstand 7 cm.
- DE** Auflangeschienen für bleche 800 (GN-2/1) N. 4 Etagen, Abstand 7 cm.
- FR** Kit porte-plaques 800 (GN-2/1) - N. 4 étagères; 7 cm.
- ES** **PORTACAZUELAS 800 (GN-2/1) - N. 4 ESTANTES, INT. 7 CM.**

€ 632,00

 cm. 5 x 60 x 32h / kg 4 / m³ 0,010
TG-4

07580400

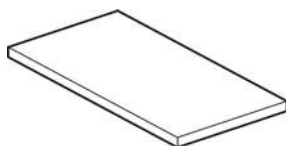

TAGLIERE PLASTICA

- EN** Plastic chopping-board
- DE** Schneidebrett
- FR** Plan de decoupe
- ES** **PICADOR DE PLÁSTICO**

€ 175,00

cm. 39 x 58 x 2,5h

 cm. 41 x 60 x 4h / kg 6 / m³ 0,010
TG-6

07580600

cm. 59 x 58 x 2,5h

 cm. 61 x 60 x 4h / kg 9 / m³ 0,015

€ 258,00

TG-8

07580800

cm. 79 x 58 x 2,5h

 cm. 81 x 60 x 4h / kg 11 / m³ 0,019

€ 334,00

OPT-GA

ACCENSIONE ELETTRICA PER APPARECCHI GAS: PC-74GA, PC-78GA, PC-712GA, CF6-712GAV, CF6-712GA, CF4-78GA - CF4-78GAE, CF6-712GAEV, CF6-712GAE, CFV4-78GAE, CFV6-712GAEV (PREZZO A BRUCIATORE)

- EN** electric ignition for gas model: PC-74GA, PC-78GA, PC-712GA, CF6-712GAV, CF6-712GA, CF4-78GA - CF4-78GAE, CF6-712GAEV, CF6-712GAE, CFV4-78GAE, CFV6-712GAEV (PRICE FOR 1 BURNER)

- DE** elektrische Zündung für gas modell: PC-74GA, PC-78GA, PC-712GA, CF6-712GAV, CF6-712GA, CF4-78GA - CF4-78GAE, CF6-712GAEV, CF6-712GAE, CFV4-78GAE, CFV6-712GAEV (PREIS FÜR 1 BRENNER)

- FR** allumage électrique pour modèle a gaz: PC-74GA, PC-78GA, PC-712GA, CF6-712GAV, CF6-712GA, CF4-78GA - CF4-78GAE, CF6-712GAEV, CF6-712GAE, CFV4-78GAE, CFV6-712GAEV (PRIX POUR 1 BRÛLEUR)

- ES** **IGNICIÓN ELÉCTRICA PARA MODELO GAS: PC-74GA, PC-78GA, PC-712GA, CF6-712GAV, CF6-712GA, CF4-78GA - CF4-78GAE, CF6-712GAEV, CF6-712GAE, CFV4-78GAE, CFV6-712GAEV (PRECIO POR 1 QUEMADOR)**

 0,01 KW
 230V~
 50/60 Hz

€ 270,00

532005901

GRIGLIA 1 FUOCO

- EN** 1 flame grill
- DE** Rost 1 flamme
- FR** Frille 1 feu
- ES** **PARILLA 1 QUEMADOR**

€ 119,00

 cm. 40 x 30 x 10h / kg 3 / m³ 0,012

533009200

GRIGLIA DI RIDUZIONE

- EN Reduction
- DE Reduzierstern
- FR Grille de réduction
- ES **REJILLA DE REDUCCIÓN**

cm. 25 x 25

 cm. 28 x 28 x 2h / kg 0.2 / m³ 0,002

€ 44,00
KIT-WOK

09580040



KIT WOK - FIAMMA VERTICALE - SOLO SU BRUCIATORE DA 10 KW E GRIGLIE IN GHISA

- EN KIT WOK - vertical flame - only for 10 kW burner and cast iron grills
- DE KIT WOK - vertikaler Flamme - nur 10 kW-Brenner und Roste aus Gusseisen
- FR KIT WOK - verticale de la flamme - seulement 10 kW brûleur et grilles en fonte
- ES **KIT WOK - LLAMA VERTICAL - SÓLO 10 KW QUEMADOR Y PARRILAS DE HIERRO COLADO**

cm. Ø 26 x 16h

 cm. 27 x 27 x 20h / kg 5 / m³ 0,015

€ 470,00
CEAT

19580010



COLONNINA EROGAZIONE ACQUA TOP

- EN Pillar tap top
- DE Mischbatterie top
- FR Colonne de distribution eau top
- ES **RUBINETO DISPENSADOR DE AGUA TOP**

 cm. 81 x 40 x 11h / kg 5 / m³ 0,036

€ 473,00

S70/90	S70T/90T	
BM	BMT	E/G
BRF		E/G
CF		E/G
CW	CWT	E/G
CWK	CWKT	E
FT	FTT	E/G
PA	PAT	G
PAF		G
PC	PCT	E/G
PCC	PCCT	E
PCI	PCIT	E
TP	TPT	E/G
TPF		E/G
TPI	TPIRT	E
PL	PLT	

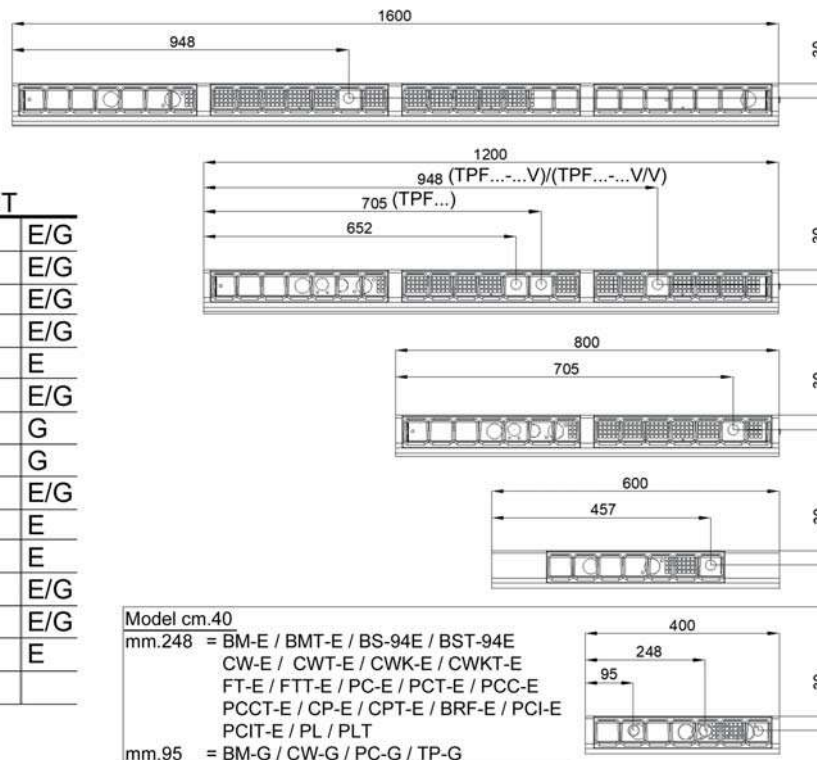

PLF

07590401



PIASTRA LISCIA PER GRIGLIA IN GHISA

- EN** Smooth griddle plate for cast iron grid
- DE** Fortkochplatte glatt für Gusseisen Rost
- FR** Plaque lisse pour la grille en fonte

ES PLANCHA LISA PARA REJILLA DE HIERRO FUNDIDO

↙ cm. 35 x 27

📦 cm. 38 x 30 x 6h / kg 9 / m³ 0,007**€ 212,00****PLF/2**

07590421



PIASTRA LISCIA 2 FUOCHI PER GRIGLIA IN GHISA

- EN** Smooth griddle plate 2 burners for cast iron grid
- DE** Fortkochplatte glatt 2 Kochstellen für Gusseisen Rost
- FR** Plaque lisse 2 feux pour la grille en fonte

ES PLANCHA LISA 2 QUEMADORES PARA REJILLA DE HIERRO FUNDIDO

↙ cm. 35 x 57

📦 cm. 38 x 60 x 6h / kg 18 / m³ 0,014**€ 417,00****PRF**

07590403



PIASTRA RIGATA PER GRIGLIA IN GHISA

- EN** Grooved griddle plate for cast iron grid
- DE** Fortkochplatte gerillt für Gusseisen Rost
- FR** Plaque nervurée pour la grille en fonte

ES PLANCHA ESTRIADA PARA REJILLA DE HIERRO FUNDIDO

↙ cm. 35 x 27

📦 cm. 38 x 30 x 6h / kg 9 / m³ 0,007**€ 283,00****PRF/2**

07590423



PIASTRA RIGATA 2 FUOCHI PER GRIGLIA IN GHISA

- EN** Grooved griddle plate 2 burners for cast iron grid
- DE** Fortkochplatte gerillt 2 Kochstellen für Gusseisen Rost
- FR** Plaque nervurée 2 feux pour la grille en fonte

ES PLANCHA ESTRIADA 2 QUEMADORES PARA REJILLA DE HIERRO FUNDIDO

↙ cm. 35 x 57

📦 cm. 38 x 60 x 6h / kg 18 / m³ 0,014**€ 464,00****PLFT/7**

08590451



PIASTRA LISCIA PER GRIGLIA IN TONDINO

- EN** Smooth griddle plate for grid rod
- DE** Fortkochplatte glatt für Gitterstab
- FR** Plaque lisse pour tige grille

ES PLANCHA LISA POR RED DE VARILLA

↙ cm. 35 x 27

📦 cm. 38 x 30 x 6h / kg 9 / m³ 0,007**€ 212,00****PLFT/72**

08590471



PIASTRA LISCIA 2 FUOCHI PER GRIGLIA IN TONDINO

- EN** Smooth griddle plate 2 burners for grid rod
- DE** Fortkochplatte glatt 2 Kochstellen für Gitterstab
- FR** Plaque lisse 2 feux pour tige grille

ES PLANCHA LISA 2 QUEMADORES POR RED DE VARILLA

↙ cm. 35 x 57

📦 cm. 38 x 60 x 6h / kg 18 / m³ 0,014**€ 417,00****PRFT/7**

08590453



PIASTRA RIGATA PER GRIGLIA IN TONDINO

- EN** Grooved griddle plate for grid rod
- DE** Fortkochplatte gerillt für Gitterstab
- FR** Plaque nervurée pour tige grille

ES PLANCHA ESTRIADA POR RED DE VARILLA

↙ cm. 35 x 27

📦 cm. 38 x 30 x 6h / kg 9 / m³ 0,007**€ 283,00**

PRFT/72

08590473



PIASTRA RIGATA 2 FUOCHI PER GRIGLIA IN TONDINO

- EN** Grooved griddle plate 2 burners for grid rod
- DE** Fortkochplatte gerillt 2 Kochstellen für Gitterstab
- FR** Plaque nervurée 2 feux pour tige grille

ES PLANCHA ESTRIADA 2 QUEMADORES POR RED DE VARILLA

cm. 35 x 57

 cm. 38 x 60 x 6h / kg 18 / m³ 0,014

€ 464,00
RV

08660410



RISCALDANTE VANO

- EN** Heater for cabinet
- DE** Heizer für Schrankelement
- FR** Réchauffeur pour armoire

ES ELEMENTO DE CALEFACCIÓN PARA ARMARIO NEUTRO

cm. 32 x 48,5 x 8h

 cm. 48 x 62 x 28h / kg 8 / m³ 0,083

 ⚡ 0,75 kW
 230V~
 50/60 Hz

€ 1.004,00
RCRV-74

08450402



RIPIANO FORATO IN APPOGGIO PER RISCALDANTE SU VANO CUCINA

- EN** Perforated shelf for heater element mod.RV for cooker cabinet
- DE** regale Gelocht für Heizer mod.RV für Herden-Schrankelement
- FR** Étagère perforées pour réchauffeur mod.RV pour armoire du fourneau

ES ESTANTE PERFORADO PARA ELEMENTO DE CALEFACCION MOD.RV PARA ARMARIO NEUTRO DE LA COCINA

cm. 34 x 55 x 10h

 cm. 37 x 60 x 13h / kg 5 / m³ 0,029

€ 391,00
RRV-74

08450401

RIPIANO FORATO IN APPOGGIO PER RISCALDANTE

- EN** Perforated shelf for heater element mod.RV
- DE** regale Gelocht für Heizer mod.RV
- FR** Étagère perforées pour réchauffeur mod.RV

ES ESTANTE PERFORADO PARA ELEMENTO DE CALEFACCION MOD.RV

cm. 34 x 57 x 10h

 cm. 37 x 60 x 13h / kg 5 / m³ 0,029

€ 391,00
RRV-76

08450601

cm. 54 x 57 x 10h

 cm. 57 x 60 x 13h / kg 7 / m³ 0,044

€ 599,00
RRV-78

08450801

cm. 74 x 57 x 10h

 cm. 77 x 60 x 13h / kg 9 / m³ 0,060

€ 861,00
RRV-710

08451001

cm. 94 x 57 x 10h

 cm. 97 x 60 x 13h / kg 11 / m³ 0,076

€ 1.079,00

RRV-712

08451201

cm. 114 x 57 x 10h

 cm. 117 x 60 x 13h / kg 14 / m³ 0,091

€ 1.381,00
RRV-716

08451601

cm. 154 x 57 x 10h

 cm. 157 x 60 x 13h / kg 18 / m³ 0,122

€ 1.758,00

SIA-7/9

08480000

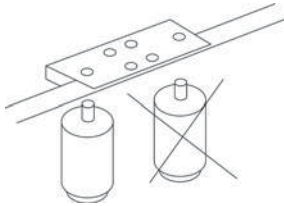

STAFFA INFERIORE UNIONE APPARECCHI

- EN Lower bracket to join two items
- DE Unterer Halter zur Verbindung zweier Teile
- FR Support inférieur permettant d'assembler deux éléments
- ES **SOPORTE INFERIOR PARA UNIR DOS ELEMENTOS**

 cm. 21 x 11 x 10h / kg 2 / m³ 0,002

€ 66,00

SR-100

50900001

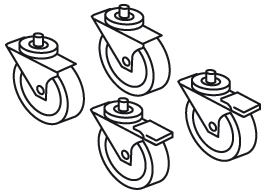

SET 4 RUOTE Ø 100X30, 2 CON FRENO

- EN Set of 4 wheels Ø 100x30, 2 with brake
- DE 4 Rollen Satz Ø 100x30, 2 davon mit Feststellbremse
- FR Kit 4 roues Ø 100x30, 2 avec frein
- ES **EQUIPO 4 RUEDAS Ø 100X30, 2 CON FRENOS**

cm. 12,7h

 cm. 30 x 20 x 20h / kg 1 / m³ 0,012

€ 395,00

ZB

01410000



ZOCOLATURA BASE

- EN FRONT PLINTH
- DE GRUNDSOCKEL
- FR PLINTHE FRONTAL
- ES **ZOCOLOS BASE**

€/m x cm. 15h

€ 159,00

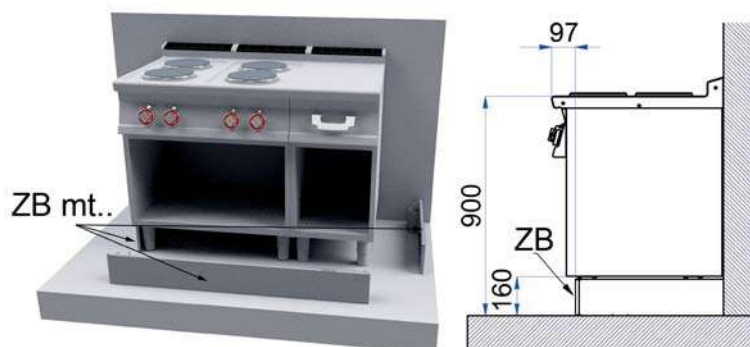
**COR1/9-20**

08570202



CORRIMANO FRONTALE CON INVASO, INCLUSO NR.1 TELAIO CM.20 CON BACINELLA GN1/9X10H A SCORRIMENTO

- EN Front handrail, including one 20cm sliding frame with GN1/9x10h tray
- DE Vorderer Handlauf, einschließlich eines 20 cm breiten Schieberahmens mit GN1/9x10h-Ablage
- FR Main courante avant, comprenant un cadre coulissant de 20 cm avec plateau GN1/9x10h
- ES **PASAMANOS FRONTAL, INCLUYE 1 MARCO DESLIZANTE DE 20 CM CON BANDEJA GN1/9X10H**

cm. 20 x 14X 5h

 cm. 24 x 20 x 15h / kg 1 / m³ 0,007

€ 363,00

COR1/9-30

08570203

cm. 30 x 14X 5h

 cm. 34 x 20 x 15h / kg 1.1 / m³ 0,010

€ 367,00

COR1/9-40
 08570204

CORRIMANO FRONTALE CON INVASO, INCLUSO NR.1 TELAIO CM.20 CON BACINELLA GN1/9X10H E NR.1 GRIGLIA CM.20 A SCORRIMENTO

EN Front handrail, including one 20cm frame with GN1/9x10h tray and one 20cm sliding grid

DE Vorderer Handlauf, einschließlich eines 20 cm Rahmens mit GN1/9x10h Ablage und eines 20 cm Schiebegitters

FR Main courante avant, comprenant un cadre de 20 cm avec plateau GN1/9x10h et une grille coulissante de 20 cm

ES **PASAMANOS FRONTAL, INCLUYE 1 MARCO DE 20 CM CON BANDEJA GN1/9X10H Y 1 REJILLA DESLIZANTE DE 20 CM**

↳ cm. 40 x 14X 5h

📦 cm. 44 x 20 x 15h / kg 1.6 / m³ 0,013

€ 393,00
COR1/9-50
 08570205

↳ cm. 50 x 14X 5h

📦 cm. 54 x 20 x 15h / kg 2 / m³ 0,016

€ 415,00
COR1/9-60
 08570206

↳ cm. 60 x 14X 5h

📦 cm. 64 x 20 x 15h / kg 2.4 / m³ 0,019

€ 433,00
COR1/9-70
 08570207

↳ cm. 70 x 14X 5h

📦 cm. 74 x 20 x 15h / kg 2.8 / m³ 0,022

€ 456,00
COR1/9-80
 08570208

↳ cm. 80 x 14X 5h

📦 cm. 84 x 20 x 15h / kg 3.2 / m³ 0,025

€ 477,00
COR1/9-90
 08570209

↳ cm. 90 x 14X 5h

📦 cm. 94 x 20 x 15h / kg 3.6 / m³ 0,028

€ 492,00
COR1/9-100
 08570210

↳ cm. 100 x 14X 5h

📦 cm. 104 x 20 x 15h / kg 4 / m³ 0,031

€ 517,00
COR1/9-110
 08570211

↳ cm. 110 x 14X 5h

📦 cm. 114 x 20 x 15h / kg 7.7 / m³ 0,034

€ 536,00
COR1/9-120
 08570212

↳ cm. 120 x 14X 5h

📦 cm. 124 x 20 x 15h / kg 8.4 / m³ 0,037

€ 558,00
KIT-COR1/9
 0857020A

KIT NR.1 TELAIO CM.20 CON BACINELLA GN1/9X10H E NR.1 GRIGLIA CM.20 A SCORRIMENTO

EN Kit one 20cm frame with GN1/9x10h tray and one 20cm sliding grid

DE kit eines 20 cm Rahmens mit GN1/9x10h Ablage und eines 20 cm Schiebegitters

FR Kit un cadre de 20 cm avec plateau GN1/9x10h et une grille coulissante de 20 cm

ES **KIT 1 MARCO DE 20 CM CON BANDEJA GN1/9X10H Y 1 REJILLA DESLIZANTE DE 20 CM**

↳ cm.20/20 x 12X 10h

📦 cm. 21 x 15 x 15h / kg 0.2 / m³ 0,005

€ 91,00

TPA-7

08560001



TESTATA CHIUSURA PIANO (IN DOTAZIONE 1 PEZZO PER APPARECCHIO)

€ 79,00**EN** Head end filler strip (1 piece included in each machine)**DE** Abschluss-Element (1 Stück in jeder Maschine enthalten)**FR** Élément de jonction top (1 pièce incluse dans chaque machine)**ES** CHAPA DE CIERRE PARA TOP (1 PIEZA INCLUIDA EN CADA EQUIPO)

↳ cm. 0,2 x 70,5

📦 cm. 2 x 72 x 15h / kg 1 / m³ 0,002**TMA-7SX**

08540701



TESTATA 1 LATO SERIE 70 SINISTRA

€ 288,00**EN** Head 1 side S70 left**DE** Abschluss element 1 seite S70 links**FR** Element de jonction 1 coté S70 gauche**ES** EMBELLECEDOR 1 LADO S70 IZQUIERDA

↳ cm. 0,2 x 70,5

📦 cm. 100 x 3 x 100h / kg 8 / m³ 0,030**TMA-7DX**

08540700



TESTATA 1 LATO SERIE 70 DESTRA

€ 288,00**EN** Head 1 side S70 right**DE** Abschluss element 1 seite S70 recht**FR** Element de jonction 1 coté S70 droit**ES** EMBELLECEDOR 1 LADO S70 DERECHA

↳ cm. 0,2 x 70,5

📦 cm. 100 x 3 x 100h / kg 8 / m³ 0,030**TMA-77**

08547700



TESTATA 2 LATI SERIE 70

€ 579,00**EN** Head 2 sides S70**DE** Abschluss element seiten S70**FR** Element de jonction 2 cotés S70**ES** EMBELLECEDOR 2 LADOS S70

↳ cm. 0,2 x 141

📦 cm. 200 x 3 x 100h / kg 16 / m³ 0,060**TMA-79SX**

08547901



TESTATA 2 LATI SERIE 70/90 SINISTRA

€ 592,00**EN** Head 2 sides S70/90 left**DE** Abschluss element seiten S70/90 links**FR** Element de jonction 2 cotés S70/90 gauche**ES** EMBELLECEDOR 2 LADOS S70/90 IZQUIERDA

↳ cm. 0,2 x 160,5

📦 cm. 200 x 3 x 100h / kg 18 / m³ 0,060

TMA-79DX

08547900



TESTATA 2 LATI SERIE 70/90 DESTRA

- EN** Head 2 sides S70/90 right
- DE** Abschluss element seiten S70/90 recht
- FR** Element de jonction 2 cotés S70/90 droit
- ES** **EMBELLECEDOR 2 LADOS S70/90 DERECHA**

cm. 0,2 x160,5

 cm. 200 x 3 x 100h / kg 18 / m³ 0,060

€ 592,00
TMTA-7SX

08540721



TESTATA TAMBURATA 1 LATO SERIE 70 SINISTRA, CON STESSO PROFILO LINEA FRONTALE

- EN** Head 1 side S70 left, with the same front line profile
- DE** Abschluss element 1 seite S70 links, mit dem gleichen Frontlinienprofil
- FR** Element de jonction 1 coté S70 gauche, avec le même profil de ligne
- ES** **EMBELLECEDOR 1 LADO S70 IZQUIERDA, CON EL MISMO PERFIL DE LÍNEA FRONTAL**

cm. 7,5 x 70,5

 cm. 78 x 87 x 23h / kg 14 / m³ 0,156

€ 907,00
TMTA-7DX

08540720



TESTATA TAMBURATA 1 LATO SERIE 70 DESTRA, CON STESSO PROFILO LINEA FRONTALE

- EN** Head 1 side S70 right, with the same front line profile
- DE** Abschluss element 1 seite S70 recht, mit dem gleichen Frontlinienprofil
- FR** Element de jonction 1 coté S70 droit, avec le même profil de ligne
- ES** **EMBELLECEDOR 1 LADO S70 DERECHA, CON EL MISMO PERFIL DE LÍNEA FRONTAL**

cm. 7,5 x 70,5

 cm. 78 x 87 x 23h / kg 14 / m³ 0,156

€ 907,00
TMTA-77

08547720



TESTATA TAMBURATA 2 LATI SERIE 70, CON STESSO PROFILO LINEA FRONTALE

- EN** Head 2 sides S70, with the same front line profile
- DE** Abschluss element seiten S70, mit dem gleichen Frontlinienprofil
- FR** Element de jonction 2 cotés S70, avec le même profil de ligne
- ES** **EMBELLECEDOR 2 LADOS S70, CON EL MISMO PERFIL DE LÍNEA FRONTAL**

cm. 7,5 x 141

 cm. 148 x 87 x 23h / kg 28 / m³ 0,296

€ 1.756,00
TMTA-79

08547920

TESTATA TAMBURATA 2 LATI SERIE 70/90, CON STESSO PROFILO LINEA FRONTALE

- EN** Head 2 sides S70/90, with the same front line profile
- DE** Abschluss element seiten S70/90, mit dem gleichen Frontlinienprofil
- FR** Element de jonction 2 cotés S70/90, avec le même profil de ligne
- ES** **EMBELLECEDOR 2 LADOS S70/90, CON EL MISMO PERFIL DE LÍNEA FRONTAL**

cm. 7,5 x160,5

 cm. 168 x 87 x 23h / kg 30 / m³ 0,336

€ 1.784,00

SA-72/92

08600200



SCHIENA POSTERIORE A VISTA PER APPARECCHI

EN Back cover
DE Rückenwand
FR Dos de finition
ES **PANEL POSTERIOR**

↙ cm. 20 x 1,5 x 97h
 ↻ cm. 22 x 3 x 98h / kg 2 / m³ 0,006

€ 116,00**SA-73/93**

08600300

↙ cm. 30 x 1,5 x 97h
 ↻ cm. 32 x 3 x 98h / kg 3 / m³ 0,009

€ 132,00**SA-74/94**

08600400

↙ cm. 40 x 1,5 x 97h
 ↻ cm. 42 x 3 x 98h / kg 3 / m³ 0,012

€ 150,00**SA-75/95**

08600500

↙ cm. 50 x 1,5 x 97h
 ↻ cm. 52 x 3 x 98h / kg 4 / m³ 0,015

€ 189,00**SA-76/96**

08600600

↙ cm. 60 x 1,5 x 97h
 ↻ cm. 62 x 3 x 98h / kg 4 / m³ 0,018

€ 218,00**SA-77/97**

08600700

↙ cm. 70 x 1,5 x 97h
 ↻ cm. 72 x 3 x 98h / kg 5 / m³ 0,021

€ 231,00**SA-78/98**

08600800

↙ cm. 80 x 1,5 x 97h
 ↻ cm. 82 x 3 x 98h / kg 5 / m³ 0,024

€ 255,00**SA-79/99**

08600900

↙ cm. 90 x 1,5 x 97h
 ↻ cm. 92 x 3 x 98h / kg 6 / m³ 0,027

€ 286,00**SA-710/910**

08601000

↙ cm. 100 x 1,5 x 97h
 ↻ cm. 102 x 3 x 98h / kg 6 / m³ 0,030

€ 318,00**SA-711/911**

08601100

↙ cm. 110 x 1,5 x 97h
 ↻ cm. 112 x 3 x 98h / kg 7 / m³ 0,033

€ 351,00**SA-712/912**

08601200

↙ cm. 120 x 1,5 x 97h
 ↻ cm. 122 x 3 x 98h / kg 7 / m³ 0,036

€ 382,00**SA-713/913**

08601300

↙ cm. 130 x 1,5 x 97h
 ↻ cm. 132 x 3 x 98h / kg 8 / m³ 0,039

€ 415,00**SA-714/914**

08601400

↙ cm. 140 x 1,5 x 97h
 ↻ cm. 142 x 3 x 98h / kg 8 / m³ 0,042

€ 445,00

SA-715/915 08601500	↙ cm. 150 x 1,5 x 97h 📦 cm. 152 x 3 x 98h / kg 10 / m ³ 0,045	€ 476,00
SA-716/916 08601600	↙ cm. 160 x 1,5 x 97h 📦 cm. 162 x 3 x 98h / kg 10 / m ³ 0,048	€ 508,00
SA-74FG 08600401	SCHIENA POSTERIORE A VISTA PER FRIGGITRICI GAS (NO F2/8-74G) EN Back cover for Gas Fryer (no F2/8-74G) DE Ruckenwand für Gas-Friteuse (no F2/8-74G) FR Dos de finition pour Friteuse a gaz (no F2/8-74G) ES PANEL POSTERIOR PARA FREIDORAS A GAS (NO F2/8-74G) ↙ cm. 40 x 1,5 x 110h 📦 cm. 42 x 3 x 112h / kg 3 / m ³ 0,014	€ 174,00
SA-78FG 08600801	SCHIENA POSTERIORE A VISTA PER FRIGGITRICI GAS EN Back cover for Gas Fryer DE Ruckenwand für Gas-Friteuse FR Dos de finition pour Friteuse a gaz ES PANEL POSTERIOR PARA FREIDORAS A GAS ↙ cm. 80 x 1,5 x 110h 📦 cm. 82 x 3 x 112h / kg 5 / m ³ 0,028	€ 276,00
SA-78F45G 08600803	SCHIENA POSTERIORE A VISTA PER FRIGGITRICE GAS F45-78G EN Back cover for Gas Fryer F45-78G DE Ruckenwand für Gas-Friteuse F45-78G FR Dos de finition pour Friteuse a gaz F45-78G ES PANEL POSTERIOR PARA FREIDORAS A GAS F45-78G ↙ cm. 80 x 1,5 x 137h 📦 cm. 82 x 3 x 139h / kg 6 / m ³ 0,034	€ 288,00

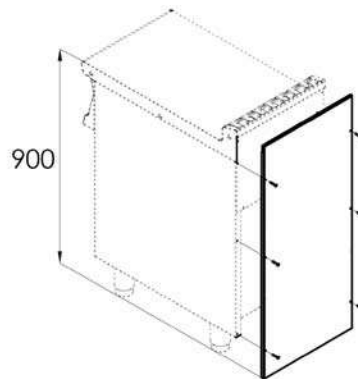

09610800

MITRA 800

EN Chimney jack 800**DE** Lüftungsaufsatz 800**FR** Mitre 800**ES** **CAPERUZA 800**

↙ cm. 80 x 7 x 92h

/ kg 16

€ 651,00**09611200**

MITRA 1200

EN Chimney jack 1200**DE** Lüftungsaufsatz 1200**FR** Mitre 1200**ES** **CAPERUZA 1200**

↙ cm. 120 x 7 x 92h

/ kg 24

€ 869,00**08610802**

MITRA 800 PER F45-78G

EN Chimney jack 800**DE** Lüftungsaufsatz 800**FR** Mitre 800**ES** **CAPERUZA 800**

↙ cm. 80 x 7 x 52h

/ kg 16

€ 651,00**09610801**

CAMINO ANTIVENTO 800

EN Draught diverter 800**DE** Strömungssicherung 800**FR** Cheminee anti-vent 800**ES** **CHIMENEA CONTRA VIENTO 800**

↙ cm. 80 x 19 x 120h

/ kg 16

€ 916,00**09611201**

CAMINO ANTIVENTO 1200

EN Draught diverter 1200**DE** Strömungssicherung 1200**FR** Cheminee anti-vent 1200**ES** **CHIMENEA CONTRA VIENTO 1200**

↙ cm. 120 x 19 x 120h

/ kg 24

€ 1.209,00**08610803**

CAMINO ANTIVENTO 800 PER F45-78G

EN Draught diverter 800 for F45-78G**DE** Strömungssicherung 800 für F45-78G**FR** Cheminee anti-vent 800 pour F45-78G**ES** **CHIMENEA CONTRA VIENTO 800 PARA F45-78G**

↙ cm. 80 x 19 x 77h

/ kg 16

€ 916,00

ACCESSORI CUOCIPASTA
EN PASTA COOKERS ACCESSORIES DE ZUBEHÖR NUDELKOCHER FR ACCESSOIRES CUISEURS DE PÂTES ES ACCESORIOS CUECEPASTAS
531070200

CESTO 1/1 PER CP-74/78
EN Basket 1/1 for CP-74/78
DE Korb 1/1 für CP-74/78
FR Panier 1/1 pour CP-74/78
ES **CESTA 1/1 PARA CP-74/78**
 ↳ cm. 28 x 32 x 21,5h
 📦 cm. 38 x 42 x 35h / kg 2 / m³ 0,056

€ 190,00
531032400

CESTO 1/2 PER CP-74/78
EN Basket 1/2 for CP-74/78
DE Korb 1/2 für CP-74/78
FR Panier 1/2 pour CP-74/78
ES **CESTA 1/2 PARA CP-74/78**
 ↳ cm. 14 x 32 x 20h
 📦 cm. 24 x 57 x 35h / kg 1.5 / m³ 0,048

€ 132,00
531047900

↳ cm. 28 x 16 x 21,5h
 📦 cm. 38 x 26 x 35h / kg 1.5 / m³ 0,035

€ 137,00
531048000

CESTO 1/4 PER CP-74/78
EN Basket 1/4 for CP-74/78
DE Korb 1/4 für CP-74/78
FR Panier 1/4 pour CP-74/78
ES **CESTA 1/4 PARA CP-74/78**
 ↳ cm. 13,5 x 16 x 21,5h
 📦 cm. 24 x 26 x 35h / kg 1 / m³ 0,022

€ 105,00
531032600

CESTO 1/6 PER CP-74/78
EN Basket 1/6 for CP-74/78
DE Korb 1/6 für CP-74/78
FR Panier 1/6 pour CP-74/78
ES **CESTA 1/6 PARA CP-74/78**
 ↳ cm. 14 x 10 x 20h
 📦 cm. 24 x 20 x 35h / kg 0.7 / m³ 0,017

€ 92,00

531053900

CESTO 1/1 PER CP-76

- EN** Basket 1/1 for CP-76
- DE** Korb 1/1 für CP-76
- FR** Panier 1/1 pour CP-76
- ES** **CESTA 1/1 PARA CP-76**

cm. 49 x 29 x 20h

 cm. 59 x 39 x 35h / kg 3,5 / m³ 0,081
€ 203,00**531017900**

CESTO 1/3 PER CP-76

- EN** Basket 1/3 for CP-76
- DE** Korb 1/3 für CP-76
- FR** Panier 1/3 pour CP-76
- ES** **CESTA 1/3 PARA CP-76**

cm. 16 x 29 x 20h

 cm. 26 x 54 x 35h / kg 1,5 / m³ 0,049
€ 149,00**531064300**

CESTO 1/4 PER CP-76

- EN** Basket 1/4 for CP-76
- DE** Korb 1/4 für CP-76
- FR** Panier 1/4 pour CP-76
- ES** **CESTA 1/4 PARA CP-76**

cm. 11,5 x 29 x 20h

 cm. 22 x 54 x 35h / kg 1,2 / m³ 0,042
€ 134,00**531071100**

CESTO CON GANCIO 1/2 PER CP-74/78

- EN** Basket with hook 1/2 for CP-74/78
- DE** Korb mit Haken 1/2 für CP-74/78
- FR** Panier avec crochet 1/2 pour CP-74/78
- ES** **CESTA CON GANCHO 1/2 PARA CP-74/78**

cm. 14,5 x 29 x 20h

 cm. 25 x 54 x 35h / kg 1,5 / m³ 0,047
€ 185,00**531071200**

CESTO CON GANCIO 1/3 PER CP-76

- EN** Basket with hook 1/3 for CP-76
- DE** Korb mit Haken 1/3 für CP-76
- FR** Panier avec crochet 1/3 pour CP-76
- ES** **CESTA CON GANCHO 1/3 PARA CP-76**

cm. 15 x 26 x 20h

 cm. 25 x 51 x 35h / kg 1,5 / m³ 0,045
€ 162,00**531018700**

CESTO CON GANCIO 1/4 PER CP-76

- EN** Basket with hook 1/4 for CP-76
- DE** Korb mit Haken 1/4 für CP-76
- FR** Panier avec crochet 1/4 pour CP-76
- ES** **CESTA CON GANCHO 1/4 PARA CP-76**

cm. 11 x 26 x 20h

 cm. 21 x 51 x 35h / kg 1,2 / m³ 0,037
€ 135,00

531069300

GRIGLIA SUPPORTO CESTI CON GANCIO PER CP-74/78

€ 157,00
EN support for baskets with hook for CP-74/78

DE Unterstützung für Körbe mit Haken für CP-74/78

FR soutien pour les paniers avec crochet pour CP-74/78

ES SOPORTE PARA CESTAS CON GANCHO PARA CP-74/78

cm. 30 x 33 x 41h

 cm. 35 x 38 x 46h / kg 3.5 / m³ 0,061

531069400

GRIGLIA SUPPORTO CESTI CON GANCIO PER CP-76

€ 201,00
EN support for baskets with hook for CP-76

DE Unterstützung für Körbe mit Haken für CP-76

FR soutien pour les paniers avec crochet pour CP-76

ES SOPORTE PARA CESTAS CON GANCHO PARA CP-76

cm. 50 x 29 x 41h

 cm. 55 x 34 x 46h / kg 4 / m³ 0,086

ACCESSORI FRY-TOP
EN GRIDDLE ACCESSORIES **DE** ZUBEHÖR GRIDDLEPLATTEN **FR** ACCESSOIRES FRY-TOP **ES** ACCESORIOS FRY-TOP

544023800

RASCHIETTO PER PIASTRA RIGATA

€ 71,00
EN Scraper for gooved plate

DE Schaber für gerillte Kochplatte

FR Racloir pour plaque nervurée

ES RASQUETA PARA PLACA RANURADA

 cm. 20 x 7 x 3h / kg 0.5 / m³ 0,001

531040800

RASCHIETTO PER PIASTRA LISCIA AL CROMO LUCIDO

€ 65,00
EN Scraper for smooth POLISHED CHROME plate

DE Schaber für glatte POLIERTEM CHROM Platte

FR Racloir pour plaque lisse au CHROME POLI

ES RASQUETA PARA PLACA LISA DE CROMO PULIDO

 cm. 20 x 7 x 3h / kg 0.5 / m³ 0,001

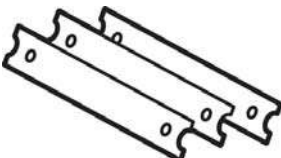
531040900

KIT 10 LAME PER RASCHIETTO COD.531040800

€ 46,00
EN 10 blades kit for scraper cod.531040800

DE Kit 10 klingen für Schaber cod.531040800

FR Kit de 10 lames pour racloir cod.531040800

ES KIT DE 10 CUCHILLAS PARA RASQUETA COD.531040800

 cm. 10 x 10 x 5h / kg 0.5 / m³ 0,001

T-FT

09580060



TAPPO PER FRY-TOP

- EN** stopper for Fry-top
- DE** Stopfen griddleplatte
- FR** bouchon pour Plaque
- ES** **TAPÓN FRY-TOP**

- cm. 10 x 2 x 5h
- cm. 20 x 20 x 10h / kg 0.5 / m³ 0,004

€ 275,00

PFT-74

08620400



KIT PROTEZIONE FRONTALE PIANO FRY-TOP

- EN** KIT front protection plan fry-top
- DE** Schutz-kit vorne Plan griddleplatte
- FR** KIT protection avant plan plaque
- ES** **KIT DE PROTECCIÓN FRONTAL PLAN DE FRY-TOP**

- cm. 35 x 8 x 6h
- cm. 41 x 11 x 9h / kg 2 / m³ 0,004

€ 141,00

PFT-76

08620600

- cm. 55 x 8 x 6h
- cm. 61 x 11 x 9h / kg 3 / m³ 0,006

€ 191,00

PFT-78

08620800

- cm. 75 x 8 x 6h
- cm. 81 x 11 x 9h / kg 4 / m³ 0,008

€ 240,00

PFT-712

08621200

- cm. 115 x 8 x 6h
- cm. 121 x 11 x 9h / kg 6 / m³ 0,012

€ 272,00

ACCESSORI GRIGLIE

EN GRILL ACCESSORIES **DE** ZUBEHÖR GRILLS **FR** ACCESSOIRES CHARCOAL **ES** ACCESORIOS BARBACOAS
08570401

GRIGLIA TONDINO PER CW (SERIE 70)

- EN** Grid for CW (70 line)
- DE** Gitter für CW (70. Serie)
- FR** Grille ronde pour CW (serie 70)
- ES** **REJILLA PARA CW (SERIE 70)**

- cm. 36 x 51 x
- cm. 40 x 65 x 10h / kg 11 / m³ 0,026

€ 469,00

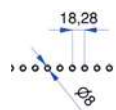
**08570402**

GRIGLIA TEGOLO V PER CW (SERIE 70)

- EN** Grid V for CW (70 line)
- DE** Gitter V für CW (70. Serie)
- FR** Grille V pour CW (serie 70)
- ES** **REJILLA V PARA CW (SERIE 70)**

- cm. 36 x 51 x
- cm. 40 x 65 x 10h / kg 11 / m³ 0,026

€ 469,00

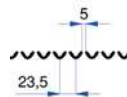

ACCESSORI FRIGGITRICI
EN FRYERS ACCESSORIES **DE** ZUBEHÖR FRITEUSE **FR** ACCESSOIRES FRITEUSE **ES** ACCESORIOS FREIDORAS

KF-F-ETD S70

546003402



KIT 100 FILTRI 5 MICRON PER F-ETDP/GDP S70

EN KIT 100 sieve 5 microns for F-ETDP/GDP S70

DE KIT 100 Filter 5-Mikron für F-ETDP/GDP S70

FR KIT 100 filtre 5 microns pour F-ETDP/GDP S70

ES KIT 100 FILTRO DE 5 MICRONES PARA F-ETDP/GDP S70

 cm. 20 x 60 x 3h / kg 0.1 / m³ 0,004

€ 446,00
531013200

CESTINO 1/2 PER F13-G/E

EN Basket 1/2 for F13-G/E

DE Korb 1/2 für F13-G/E

FR Panier 1/2 pour F13-G/E

ES CESTA 1/2 PARA F13-G/E

cm. 10 x 30 x 12h

 cm. 20 x 55 x 27h / kg 0.7 / m³ 0,030

€ 65,00
531013500

CESTINO 1/2 PER F18-70G

EN Basket 1/2 for F18-70G

DE Korb 1/2 für F18-70G

FR Panier 1/2 pour F18-70G

ES CESTA 1/2 PARA F18-70G

cm. 14 x 33 x 12h

 cm. 24 x 55 x 27h / kg 0.8 / m³ 0,036

€ 79,00
531041600

CESTINO 1/2 PER F18-E

EN Basket 1/2 for F18-E

DE Korb 1/2 zur Friteuse F18-E

FR Panier 1/2 pour F18-E

ES CESTA 1/2 PARA F18-E

cm. 13,5 x 29 x 15h

 cm. 25 x 54 x 30h / kg 0.8 / m³ 0,041

€ 86,00
531086900

CESTINO 1/1 PER F18-70GD (STANDARD IN F18-70GVP)

EN Basket 1/1 for F18-70GD (standard F18-70GVP)

DE korb 1/1 für F18-70GD (standard F18-70GVP)

FR Panier 1/1 pour F18-70GD (standard F18-70GVP)

ES CESTA 1/1 PARA F18-70GD (STANDARD F18-70GVP)

cm. 27 x 28 x 15h

 cm. 39 x 54 x 30h / kg 1.5 / m³ 0,063

€ 81,00

531087000**€ 72,00**

CESTINO 1/2 PER F18-70GVP (STANDARD IN F18-70GD)

EN Basket 1/2 for F18-70GVP (standard F18-70GD)**DE** korb 1/2 für F18-70GVP (standard F18-70GD)**FR** Panier 1/2 pour F18-70GVP (standard F18-70GD)**ES** CESTA 1/2 PARA F18-70GVP (STANDARD F18-70GD)

↳ cm. 13 x 28 x 15h

📦 cm. 25 x 54 x 30h / kg 0.8 / m³ 0,041**541417700****€ 111,00**

DEFLETTORE OLIO PER PRODOTTI INFARINATI, PER F18-70GVP + F18-70GD

EN Oil deflector for floured products, for f18-70gvp + f18-70gd**DE** Olabweiser für mehlierte produkte, für f18-70gvp + f18-70gd**FR** Déflecteur d'huile pour produits farinés, pour f18-70gvp + f18-70gd**ES** DEFLECTOR DE ACEITE PARA PRODUCTOS ENHARINADOS, PARA F18-70GVP + F18-70GD

↳ cm. 25 x 31 x 6h

📦 cm. 30 x 35 x 15h / kg 2 / m³ 0,016**531088500****€ 16,00**

GANCIO PER SOLLEVAMENTO FILTRO SEDIMENTI

EN Hook for lifting sediment filter**DE** Haken zum anheben des sedimentfilters**FR** Crochet pour soulever le filtre à sédiments**ES** GANCHO PARA LEVANTAR EL FILTRO DE SEDIMENTOS

↳ cm. 1 x 19 x 45h

📦 cm. 5 x 50 x 20h / kg 0.2 / m³ 0,005**531088600****€ 167,00**

FILTRO SEDIMENTI PER F18-70GVP + F18-70GD

EN Sediment filter for f18-70gvp + f18-70gd**DE** Sediment-filter für f18-70gvp + f18-70gd**FR** Filtre à sédiments pour f18-70gvp + f18-70gd**ES** FILTRO DE SEDIMENTOS PARA F18-70GVP + F18-70GD

↳ cm. 7 x 31 x 11h

📦 cm. 10 x 40 x 15h / kg 1 / m³ 0,006**531033300****€ 226,00**

CESTINO 1/1 F45

EN Basket 1/1 F45**DE** korb 1/1 F45**FR** Panier 1/1 F45**ES** CESTA 1/1 F45

↳ cm. 65 x 33 x 17h

📦 cm. 75 x 43 x 32h / kg 3 / m³ 0,103**531041300****€ 94,00**

CESTINO 1/2 F45, 1/1 PER F18-ETD (STANDARD IN F18-E)

EN Basket 1/2 F45, 1/1 for F18-ETD (standard F18-E)**DE** korb 1/2 F45, 1/1 für F18-ETD (standard F18-E)**FR** Panier 1/2 F45, 1/1 pour F18-ETD (standard F18-E)**ES** CESTA 1/2 F45, 1/1 PARA F18-ETD (STANDARD F18-E)

↳ cm. 28 x 29 x 15h

📦 cm. 39 x 54 x 30h / kg 1.5 / m³ 0,063

531047800

CESTINO 1/3 F45

EN Basket 1/3 F45

DE korb 1/3 F45

FR Panier 1/3 F45

ES CESTA 1/3 F45

cm. 21,5 x 33 x 16h

 cm. 32 x 58 x 32h / kg 1.3 / m³ 0,059

€ 110,00
08550801

COPERCHIO F-45 CON CESTI 1/2 E 1/3

EN Lid F45 with basket 1/2, 1/3

DE Deckel F45 mit bkorb 1/2, 1/3

FR Couvercle F45 avec panier 1/2, 1/3

ES TAPA F45 CON CESTA 1/2, 1/3

cm. 74 x 57 x 5h

 cm. 80 x 60 x 8h / kg 4 / m³ 0,038

€ 212,00
40280800

SCIVOLO INOX F45

EN Stainless steel slide F45

DE Rutsche aus Rostfreiem Stahl F45

FR Goulotte en acier inox F45

ES DESLIZADOR INOX F45

cm. 38 x 75 x 27h

 cm. 40 x 77 x 30h / kg 5 / m³ 0,092

€ 175,00

ACCESSORI BRASIERE

EN BRATTPANS ACCESSORIES DE ZUBEHÖR KIPPBRATPFANNEN FR ACCESSOIRES SAUTEUSES ES ACCESORIOS SARTENS

08550400



COPERCHIO BRF-74

EN Lid BRF-74
DE Deckel BRF-74
FR Couvercle BRF-74
ES **TAPA BRF-74**

↙ cm. 32 x 53 x 5h

📦 cm. 34 x 55 x 8h / kg 2 / m³ 0,015

€ 159,00

08550800



COPERCHIO BRF-78

EN Lid BRF-78
DE Deckel BRF-78
FR Couvercle BRF-78
ES **TAPA BRF-78**

↙ cm. 72 x 53 x 5h

📦 cm. 74 x 55 x 8h / kg 4 / m³ 0,033

€ 212,00

OPT-LAVBR50



DOCCIA LAVAGGIO MANUALE ESTRAIBILE PER BR50 (OPTIONAL ALL'ORDINE)

EN retractable hand shower for BR50 (optional when ordering)
DE einziehbare Handbrause für BR50 (optional bei Bestellung)
FR douchette manuelle rétractable pour BR50 (en option à la commande)
ES **DUCHA MANUAL RETRÁCTIL PARA BR50 (OPCIONAL AL REALIZAR EL PEDIDO)**

/ kg 2

€ 443,00

545132800



FILTRO FRONTALE AGGANCIABILE PER SCARICO LIQUIDI, PER BRASIERE RIBALTABILI S70 S90

EN ATTACHABLE FRONT FILTER FOR LIQUID DISCHARGE, for tilting Braising pan S70 S90

DE ANBAUBARER FRONTFILTER FÜR FLÜSSIGKEITSABLAUF, für Kippbratpfanne S70 S90

FR FILTRE AVANT AMOVIBLE POUR ÉVACUATION DE LIQUIDE, pour sauteuse avec basculement S70 S90

ES **FILTRO DELANTERO ACOPLABLE PARA DESCARGA DE LÍQUIDOS, PARA SARTEN LEVANTANTE S70 S90**

↙ cm. 26 x 13 x 25h

📦 cm. 30 x 20 x 30h / kg 1 / m³ 0,018

€ 86,00

FF-BR50

08480800



FALSO FONDO FORATO PER BR50

EN Perforated false bottom for BR50

DE Gelochter Bodenrost für BR50

FR Faux-fond perforé pour BR50

ES **FALSO FONDO AGUJERADO PARA BR50**

↙ cm. 70 x 36 x 2h

📦 cm. 40 x 40 x 6h / kg 3 / m³ 0,010

€ 99,00

ACCESSORI PENTOLE
EN BOILING PANS ACCESSORIES DE ZUBEHÖR KOCHKESSEL FR ACCESSOIRES MARMITES ES ACCESORIOS MARMITAS
531094500
CESTO PASTA 1/1 PER PENTOLA P50
€ 723,00
EN Pasta basket 1/1 for boiling pan P50

DE Nudelkorb 1/1 für Kochkessel P50

FR Panier à pâtes 1/1 pour marmite P50

ES **CESTA PARA PASTA 1/1 PARA MARMITA P50**
cm. Ø 36 x 40h
cm. 40 x 40 x 60h / kg 5 / m³ 0,096

531093800
CESTO RISO 1/1 PER PENTOLA P50
€ 723,00
EN Rice basket 1/1 for boiling pan P50

DE Reiskorb 1/1 für Kochpfanne P50

FR Panier à riz 1/1 pour marmite P50

ES **CESTA PARA ARROZ 1/1 PARA MARMITA P50**
cm. Ø 36 x 40h
cm. 40 x 40 x 60h / kg 5 / m³ 0,096
ISP
SCARICO PENTOLE
€ 172,00

09580020

EN Channel for pan drainage

DE Trichter zum Entleeren der Töpfe

FR Entonnoir pour vidange marmites

ES **EMBUDO PARA DESCARGAR MARMITAS**
cm. 30 x 30 x 40h / kg 5 / m³ 0,036

70 SUPERLOTUS TOP



PIANI COTTURA ELETTRICI - TOP
EN ELECTRIC BOILING UNIT - TOP DE ELEKTRO KOCHPLATTEN- TOP FR PLAN DE CUISSON ÉLECTRIQUE - TOP ES SOBRES DE COCCIÓN ELECTRICO - TOP
PCT-74ET
 18030430

PIANO COTTURA TRIFASE - N. 2 PIASTRE (INCLUSA 1 TESTATA CHIUSURA PIANO MOD. TPA-7)

EN Boiling unit threephase - N. 2 plates (included 1 Head end filler strip mod.TPA-7)

DE Kochplatte dreiphasig - N. 2 Kochplatten (inbegriffen 1 Abschluss-Element mod. TPA-7)

FR Rechaud électriques - N. 2 plaques (inclus 1 Élément de jonction top mod.TPA-7)

ES SOBRES DE COCCIÓN TRIFÁSICO - N. 2 PLANCHAS (INCLUIDA 1 CHAPA DE CIERRE PARA TOP MOD.TPA-7)

cm. 40 x 70,5 x 28h

 cm. 43 x 77 x 54h / kg 26 / m³ 0,179

 5,2 kW
 400V~2N
 230V~3
 230V~
 50/60 Hz

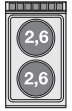
€ 1.028,00

PCT-78ET
 18030830

PIANO COTTURA TRIFASE N. 4 PIASTRE (INCLUSA 1 TESTATA CHIUSURA PIANO MOD. TPA-7)

EN Boiling unit threephase - N. 4 plates (included 1 Head end filler strip mod.TPA-7)

DE Kochplatte dreiphasig - N. 4 Kochplatten (inbegriffen 1 Abschluss-Element mod. TPA-7)

FR Rechaud électriques - N. 4 plaques (inclus 1 Élément de jonction top mod.TPA-7)

ES SOBRES DE COCCIÓN TRIFÁSICO - N. 4 PLANCHAS (INCLUIDA 1 CHAPA DE CIERRE PARA TOP MOD.TPA-7)

cm. 80 x 70,5 x 28h

 cm. 83 x 77 x 54h / kg 63 / m³ 0,345

 10,4 kW
 400V~3N
 230V~3
 50/60 Hz

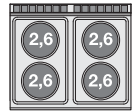
€ 1.629,00

PCT-712ET
 18031230

PIANO COTTURA TRIFASE N. 6 PIASTRE (INCLUSA 1 TESTATA CHIUSURA PIANO MOD. TPA-7)

EN Boiling unit threephase - N. 6 plates (included 1 Head end filler strip mod.TPA-7)

DE Kochplatte dreiphasig - N. 6 Kochplatten (inbegriffen 1 Abschluss-Element mod. TPA-7)

FR Rechaud électriques - N. 6 plaques (inclus 1 Élément de jonction top mod.TPA-7)

ES SOBRES DE COCCIÓN TRIFÁSICO - N. 6 PLANCHAS (INCLUIDA 1 CHAPA DE CIERRE PARA TOP MOD.TPA-7)

cm. 120 x 70,5 x 28h

 cm. 123 x 77 x 54h / kg 82 / m³ 0,511

 15,6 kW
 400V~3N
 230V~3
 50/60 Hz

€ 2.602,00

PCQT-74ET
 18030431

PIANO COTTURA TRIFASE - N. 2 PIASTRE QUADRE (INCLUSA 1 TESTATA CHIUSURA PIANO MOD.TPA-7)

EN Boiling unit threephase - N. 2 square plates (included 1 Head end filler strip mod. TPA-7)

DE Kochplatte dreiphasig - N. 2 quadratischen Platten (inbegriffen 1 Abschluss-Element mod.TPA-7)

FR Rechaud électriques - N. 2 plaques carrés (inclus 1 Élément de jonction top mod. TPA-7)

ES SOBRES DE COCCIÓN TRIFÁSICO - N. 2 PLANCHAS CUADRADAS (INCLUIDA 1 CHAPA DE CIERRE PARA TOP MOD.TPA-7)

cm. 40 x 70,5 x 28h

 cm. 43 x 77 x 54h / kg 30 / m³ 0,179

 5,2 kW
 400V~2N
 230V~3
 230V~
 50/60 Hz

€ 1.771,00

PCQT-78ET

18030831



PIANO COTTURA TRIFASE - N. 4 PIASTRE QUADRE (INCLUSA 1 TESTATA CHIUSURA PIANO MOD.TPA-7)

EN Boiling unit threephase - N. 4 square plates (included 1 Head end filler strip mod. TPA-7)

DE Kochplatte dreiphasig - N. 4 quadratischen Platten (inbegriffen 1 Abschluss-Element mod.TPA-7)

FR Rechaud électriques - N. 4 plaques carrés (inclus 1 Élément de jonction top mod. TPA-7)

ES **SOBRE DE COCCIÓN TRIFÁSICO - N. 4 PLANCHAS CUADRADAS (INCLUIDA 1 CHAPA DE CIERRE PARA TOP MOD.TPA-7)**

cm. 80 x 70,5 x 28h

cm. 83 x 77 x 54h / kg 66 / m³ 0,345

10,4 kW
400V~3N
230V~3
50/60 Hz

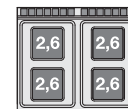
€ 3.024,00**PCQT-712ET**

18031231



PIANO COTTURA TRIFASE - N. 6 PIASTRE QUADRE (INCLUSA 1 TESTATA CHIUSURA PIANO MOD.TPA-7)

EN Boiling unit threephase - N. 6 square plates (included 1 Head end filler strip mod. TPA-7)

DE Kochplatte dreiphasig - N. 6 quadratischen Platten (inbegriffen 1 Abschluss-Element mod.TPA-7)

FR Rechaud électriques - N. 6 plaques carrés (inclus 1 Élément de jonction top mod. TPA-7)

ES **SOBRE DE COCCIÓN TRIFÁSICO - N. 6 PLANCHAS CUADRADAS (INCLUIDA 1 CHAPA DE CIERRE PARA TOP MOD.TPA-7)**

cm. 120 x 70,5 x 28h

cm. 123 x 77 x 54h / kg 97 / m³ 0,511

15,6 kW
400V~3N
230V~3
50/60 Hz

€ 4.644,00**PCCT-74ET**

18030432



PIANO COTTURA VETROCERAMICA TRIFASE - N. 2 ZONE - VETRO CM.35X57 (INCLUSA 1 TESTATA CHIUSURA PIANO MOD.TPA-7)

EN Ceramic glass boiling unit - n. 2 zones - glass cm.35x57 (included 1 Head end filler strip mod.TPA-7)

DE Ceran-Kochplatte dreiphasig - 2 zonen - Glas 35x57 cm (inbegriffen 1 Abschluss-Element mod.TPA-7)

FR Plan de cuisson à vitrocéramique triphasé N. 2 zones - Verre cm.35x57 (inclus 1 Élément de jonction top mod.TPA-7)

ES **SOBRE DE COCCIÓN TRIFÁSICO VITROCERÁMICA - 2 ZONAS - VIDRIO CM.35X57 (INCLUIDA 1 CHAPA DE CIERRE PARA TOP MOD.TPA-7)**

cm. 40 x 70,5 x 28h

cm. 43 x 77 x 54h / kg 35 / m³ 0,179

5 kW
400V~2N
230V~3
230V~
50/60 Hz

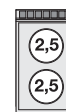
€ 2.173,00**PCCT-78ET**

18030832



PIANO COTTURA VETROCERAMICA TRIFASE - N. 4 ZONE - VETRO CM.75X57 (INCLUSA 1 TESTATA CHIUSURA PIANO MOD.TPA-7)

EN Ceramic glass boiling unit - n. 4 zones - glass cm.75x57 (included 1 Head end filler strip mod.TPA-7)

DE Ceran-Kochplatte dreiphasig - 4 zonen - Glas 75x57 cm (inbegriffen 1 Abschluss-Element mod.TPA-7)

FR Plan de cuisson à vitrocéramique triphasé N. 4 zones - Verre cm.75x57 (inclus 1 Élément de jonction top mod.TPA-7)

ES **SOBRE DE COCCIÓN TRIFÁSICO VITROCERÁMICA - 4 ZONAS - VIDRIO CM.75X57 (INCLUIDA 1 CHAPA DE CIERRE PARA TOP MOD.TPA-7)**

cm. 80 x 70,5 x 28h

cm. 83 x 77 x 54h / kg 62 / m³ 0,345

10 kW
400V~3N
230V~3
50/60 Hz

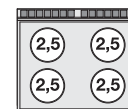
€ 3.296,00

PIANI COTTURA A INDUZIONE - TOP
EN INDUCTION BOILING UNIT - TOP DE INDUKTIONNS-KOCHPLATTEN - TOP FR PLAN DE CUISSON À INDUCTION - TOP ES SOBRES DE COCCIÓN POR INDUCCIÓN - TOP
PCIT-74ET
18030433

PIANO COTTURA INDUZIONE TRIFASE - N. 2 ZONE - VETRO CM.35X57 (NON POSIZIONARE SU FORNI O CASSETTIERE) (INCLUSA 1 TESTATA CHIUSURA PIANO MOD. TPA-7)

EN Three-phase induction cooking - 2 zones - glass cm.35x57 (do not place on ovens or drawers) (included 1 Head end filler strip mod.TPA-7)

DE Induktions-Kochplatte dreiphasig - 2 zonen - Glas 35x57 cm (nicht Platz auf Öfen oder Schubladen) (inbegriffen 1 Abschluss-Element mod.TPA-7)

FR Plan de cuisson à induction triphasé N. 2 zones - Verre cm.35x57 (ne placez pas sur des fours ou des tiroirs) (inclus 1 Élément de jonction top mod.TPA-7)

ES ENCIMERA INDUCCIÓN TRIFÁSICA - 2 ZONAS - VIDRIO CM.35X57 (NO COLOQUE EN LOS HORNOS O EN LOS CAJONES) (INCLUIDA 1 CHAPA DE CIERRE PARA TOP MOD.TPA-7)

cm. 40 x 70,5 x 28h

 cm. 43 x 77 x 54h / kg 34 / m³ 0,179

 10 kW
400V~3
50/60 Hz

€ 7.845,00
PCIWT-74ET
18030434

PIANO COTTURA INDUZIONE TRIFASE "WOK" - N. 1 ZONA - VETRO Ø 30 CM. (NON POSIZIONARE SU FORNI O CASSETTIERE) (INCLUSA 1 TESTATA CHIUSURA PIANO MOD. TPA-7)

EN Three-phase induction cooking "WOK" - 1 zone - glass Ø 30 cm (do not place on ovens or drawers) (included 1 Head end filler strip mod.TPA-7)

DE Induktions-Kochplatte "WOK" dreiphasig - 1 zonen - Glas Ø 30 cm (nicht Platz auf Öfen oder Schubladen) (inbegriffen 1 Abschluss-Element mod.TPA-7)

FR Plan de cuisson à induction "WOK" triphasé N. 1 zone - Verre cm Ø 30 (ne placez pas sur des fours ou des tiroirs) (inclus 1 Élément de jonction top mod.TPA-7)

ES ENCIMERA INDUCCIÓN "WOK" TRIFÁSICA - 1 ZONA - VIDRIO Ø 30 CM (NO COLOQUE EN LOS HORNOS O EN LOS CAJONES) (INCLUIDA 1 CHAPA DE CIERRE PARA TOP MOD.TPA-7)

cm. 40 x 70,5 x 28h

 cm. 43 x 77 x 54h / kg 32 / m³ 0,179

 4,5 kW
400V~3
50/60 Hz

€ 5.512,00
PCIT-78ET
18203833

PIANO COTTURA INDUZIONE TRIFASE - N. 4 ZONE - VETRO CM.75X57 (NON POSIZIONARE SU FORNI O CASSETTIERE) (INCLUSA 1 TESTATA CHIUSURA PIANO MOD. TPA-7)

EN Three-phase induction cooking - 4 zones - glass cm.75x57 (do not place on ovens or drawers) (included 1 Head end filler strip mod.TPA-7)

DE Induktions-Kochplatte dreiphasig - 4 zonen - Glas 75x57 cm (nicht Platz auf Öfen oder Schubladen) (inbegriffen 1 Abschluss-Element mod.TPA-7)

FR Plan de cuisson à induction triphasé N. 4 zones - Verre cm.75x57 (ne placez pas sur des fours ou des tiroirs) (inclus 1 Élément de jonction top mod.TPA-7)

ES ENCIMERA INDUCCIÓN TRIFÁSICA - 4 ZONAS - VIDRIO CM.75X57 (NO COLOQUE EN LOS HORNOS O EN LOS CAJONES) (INCLUIDA 1 CHAPA DE CIERRE PARA TOP MOD.TPA-7)

cm. 80 x 70,5 x 28h

 cm. 83 x 77 x 54h / kg 66 / m³ 0,345

 20 kW
400V~3
50/60 Hz

€ 14.882,00
PIANI COTTURA A GAS - TOP
EN GAS BOILING UNIT - TOP DE GAS KOCHPLATTEN - TOP FR PLAN DE CUISSON À GAZ - TOP ES SOBRES DE COCCIÓN DE GAS - TOP
PCT-74GP
18210450

PIANO COTTURA GAS 2 FUOCHI (INCLUSA 1 TESTATA CHIUSURA PIANO MOD.TPA-7)

EN Gas heated boiling unit - 2 burners (included 1 Head end filler strip mod.TPA-7)

DE Gas-kochplatte - 2 Kochstellen (inbegriffen 1 Abschluss-Element mod.TPA-7)

FR Rechaud gaz - 2 feux vifs (inclus 1 Élément de jonction top mod.TPA-7)

ES SOBRES DE COCCIÓN GAS - 2 QUEMADORES (INCLUIDA 1 CHAPA DE CIERRE PARA TOP MOD.TPA-7)

cm. 40 x 70,5 x 28h

 cm. 43 x 77 x 54h / kg 60 / m³ 0,179

 13 kW
11.180 kcal/h

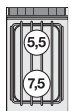
€ 1.635,00

PCT-78GP

18210850



PIANO COTTURA GAS 4 FUOCHI (INCLUSA 1 TESTATA CHIUSURA PIANO MOD.TPA-7)

EN Gas heated boiling unit - 4 burners (included 1 Head end filler strip mod.TPA-7)**DE** Gas-Kochplatte - 4 Kochstellen (inbegriffen 1 Abschluss-Element mod.TPA-7)**FR** Rechaud gaz - 4 feux vifs (inclus 1 Élément de jonction top mod.TPA-7)**ES** SOBRES DE COCCIÓN GAS - 4 QUEMADORES (INCLUIDA 1 CHAPA DE CIERRE PARA TOP MOD.TPA-7)

cm. 80 x 70,5 x 28h

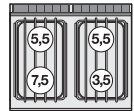
cm. 83 x 77 x 54h / kg 73 / m³ 0,34522 kW
18.920 kcal/h**€ 2.827,00****PCT-712GP**

18211250



PIANO COTTURA GAS 6 FUOCHI (INCLUSA 1 TESTATA CHIUSURA PIANO MOD.TPA-7)

EN Gas heated boiling unit - 6 burners (included 1 Head end filler strip mod.TPA-7)**DE** Gas-kochplatte - 6 Kochstellen (inbegriffen 1 Abschluss-Element mod.TPA-7)**FR** Rechaud gaz - 6 feux vifs (inclus 1 Élément de jonction top mod.TPA-7)**ES** SOBRES DE COCCIÓN GAS - 6 QUEMADORES (INCLUIDA 1 CHAPA DE CIERRE PARA TOP MOD.TPA-7)

cm. 120 x 70,5 x 28h

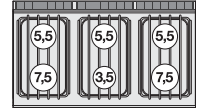
cm. 123 x 77 x 54h / kg 119 / m³ 0,51135 kW
30.100 kcal/h**€ 4.061,00****PCT1-74G**

18210453



PIANO COTTURA GAS 1 FUOCO (INCLUSA 1 TESTATA CHIUSURA PIANO MOD.TPA-7)

EN Gas heated boiling unit - 1 burner (included 1 Head end filler strip mod.TPA-7)**DE** Gas-kochplatte - 1 Kochstellen (inbegriffen 1 Abschluss-Element mod.TPA-7)**FR** Rechaud gaz - 1 feux vifs (inclus 1 Élément de jonction top mod.TPA-7)**ES** SOBRES DE COCCIÓN GAS - 1 QUEMADOR (INCLUIDA 1 CHAPA DE CIERRE PARA TOP MOD.TPA-7)

cm. 40 x 70,5 x 28h

cm. 43 x 77 x 54h / kg 60 / m³ 0,17910 kW
8.600 kcal/h**€ 1.880,00****PCT2-78G**

18210853



PIANO COTTURA GAS 2 FUOCHI (INCLUSA 1 TESTATA CHIUSURA PIANO MOD.TPA-7)

EN Gas heated boiling unit - 2 burners (included 1 Head end filler strip mod.TPA-7)**DE** Gas-kochplatte - 2 Kochstellen (inbegriffen 1 Abschluss-Element mod.TPA-7)**FR** Rechaud gaz - 2 feux vifs (inclus 1 Élément de jonction top mod.TPA-7)**ES** SOBRES DE COCCIÓN GAS - 2 QUEMADORES (INCLUIDA 1 CHAPA DE CIERRE PARA TOP MOD.TPA-7)

cm. 80 x 70,5 x 28h

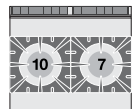
cm. 83 x 77 x 54h / kg 73 / m³ 0,34517 kW
14.620 kcal/h**€ 2.868,00****PCT3-712G**

18211253



PIANO COTTURA GAS 3 FUOCHI (INCLUSA 1 TESTATA CHIUSURA PIANO MOD.TPA-7)

EN Gas heated boiling unit - 3 burners (included 1 Head end filler strip mod.TPA-7)**DE** Gas-kochplatte - 3 Kochstellen (inbegriffen 1 Abschluss-Element mod.TPA-7)**FR** Rechaud gaz - 3 feux vifs (inclus 1 Élément de jonction top mod.TPA-7)**ES** SOBRES DE COCCIÓN GAS - 3 QUEMADORES (INCLUIDA 1 CHAPA DE CIERRE PARA TOP MOD.TPA-7)

cm. 120 x 70,5 x 28h

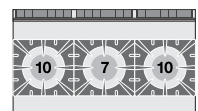
cm. 123 x 77 x 54h / kg 119 / m³ 0,51127 kW
23.220 kcal/h**€ 4.129,00**

PIANI COTTURA "PAELLERO" A GAS - TOP
EN GAS BOILING UNIT "PAELLERO" - TOP DE GAS KOCHPLATTEN "PAELLERO" - TOP FR PLAN DE CUISSON À GAZ "PAELLERO" - TOP ES SOBRES DE COCCIÓN DE GAS "PAELLERO" - TOP
PAT-78G
18210851

"PAELLERO" GAS (INCLUSA 1 TESTATA CHIUSURA PIANO MOD.TPA-7)
EN "PAELLERO" Gas (included 1 Head end filler strip mod.TPA-7)
DE "PAELLERO" Gas (inbegriffen 1 Abschluss-Element mod.TPA-7)
FR "PAELLERO" gaz (inclus 1 Élément de jonction top mod.TPA-7)
ES "PAELLERO" GAS (INCLUIDA 1 CHAPA DE CIERRE PARA TOP MOD.TPA-7)

↳ cm. 80 x 70,5 x 28h
 📦 cm. 83 x 77 x 54h / kg 127 / m³ 0,345

 11,5 kW
 9.890 kcal/h
€ 3.455,00
TUTTAPIASTRA ELETTRICO - TOP
EN ELECTRIC SOLID TOP - TOP DE ELEKTRO-KOCHPLATTEN -TOP FR TOUTE PLAQUE ÉLECTRIQUE - TOP ES PLACA DE COCCIÓN ELECTRICAS - TOP
TPT-78ET
18120830

TUTTA PIASTRA PIASTRA CM. 70X50 - 4 ZONE (INCLUSA 1 TESTATA CHIUSURA PIANO MOD.TPA-7)
EN Solid top - Plate cm. 70x50- 4 zones (included 1 Head end filler strip mod.TPA-7)
DE Kochplatten - Platte cm. 70x50 - 4 zonen (inbegriffen 1 Abschluss-Element mod. TPA-7)
FR Toute plaque - Plaque cm. 70x50 - 4 zones (inclus 1 Élément de jonction top mod. TPA-7)
ES PLACA RADIANTE - PLACA CM. 70X50 - 4 ZONAS (INCLUIDA 1 CHAPA DE CIERRE PARA TOP MOD.TPA-7)

↳ cm. 80 x 70,5 x 28h
 📦 cm. 83 x 77 x 54h / kg 116 / m³ 0,345

 10 kW
 400V~3N
 50/60 Hz
€ 3.716,00
TUTTAPIASTRA A GAS - TOP
EN GAS SOLID TOP - TOP DE GAS KOCHPLATTEN - TOP FR TOUTE PLAQUE A GAZ - TOP ES PLACA DE COCCIÓN DE GAS - TOP
TPT-74G
18290450

TUTTA PIASTRA PIASTRA CM 37X57 (INCLUSA 1 TESTATA CHIUSURA PIANO MOD.TPA-7)
EN Solid top - Plate 37x57cm (included 1 Head end filler strip mod.TPA-7)
DE Kochplatte - Platte 37x57 cm (inbegriffen 1 Abschluss-Element mod.TPA-7)
FR Toute plaque - Plaque cm 37x57 (inclus 1 Élément de jonction top mod.TPA-7)
ES PLACA RADIANTE - PLACA CM 37X57 (INCLUIDA 1 CHAPA DE CIERRE PARA TOP MOD.TPA-7)

↳ cm. 40 x 70,5 x 28h
 📦 cm. 43 x 77 x 54h / kg 60 / m³ 0,179

 7 kW
 6.020 kcal/h
€ 2.177,00
TPT-78G
18290850

TUTTA PIASTRA PIASTRA CM 77X57 (INCLUSA 1 TESTATA CHIUSURA PIANO MOD.TPA-7)
EN Solid top - Plate 77x57cm (included 1 Head end filler strip mod.TPA-7)
DE Kochplatte - Platte 77x57 cm (inbegriffen 1 Abschluss-Element mod.TPA-7)
FR Toute plaque - Plaque cm. 77x57 (inclus 1 Élément de jonction top mod.TPA-7)
ES PLACA RADIANTE - PLACA CM 77X57 (INCLUIDA 1 CHAPA DE CIERRE PARA TOP MOD.TPA-7)

↳ cm. 80 x 70,5 x 28h
 📦 cm. 83 x 77 x 54h / kg 149 / m³ 0,345

 12 kW
 10.320 kcal/h
€ 2.985,00

TP2T-78GP
18300850

TUTTA PIASTRA + 2 FUOCHI - PIASTRA CM 37X57 (INCLUSA 1 TESTATA CHIUSURA PIANO MOD.TPA-7)

EN Solid top + 2 burners - Plate 37x57 (included 1 Head end filler strip mod.TPA-7)

DE Kochplatte + 2 Gaskochstellen - Platte 37x57 (inbegriffen 1 Abschluss-Element mod.TPA-7)

FR Toute plaque + 2 brûleurs - Plaque cm 37x57 (inclus 1 Élément de jonction top mod.TPA-7)

ES **PLACA RADIANTE + 2 FUEGOS - PLACA CM 37X57 (INCLUIDA 1 CHAPA DE CIERRE PARA TOP MOD.TPA-7)**

cm. 80 x 70,5 x 28h

cm. 83 x 77 x 54h / kg 158 / m³ 0,345

20 kW
17.200 kcal/h

€ 3.453,00

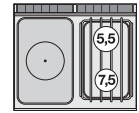
TP2T-712GP
18291250

TUTTA PIASTRA + 2 FUOCHI PIASTRA CM. 77X57 (INCLUSA 1 TESTATA CHIUSURA PIANO MOD.TPA-7)

EN Solid top + 2 burners - Plate 77x57 (included 1 Head end filler strip mod.TPA-7)

DE Kochplatte + 2 Gaskochstellen - Platte 77x57 (inbegriffen 1 Abschluss-Element mod.TPA-7)

FR Toute plaque + 2 brûleurs - Plaque cm. 77x57 (inclus 1 Élément de jonction top mod.TPA-7)

ES **PLACA RADIANTE + 2 FUEGOS - PLACA CM. 77X57 (INCLUIDA 1 CHAPA DE CIERRE PARA TOP MOD.TPA-7)**

cm. 120 x 70,5 x 28h

cm. 123 x 77 x 54h / kg 175 / m³ 0,511

25 kW
21.500 kcal/h

€ 4.361,00

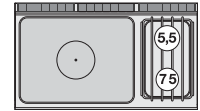
TP4T-712GP
18301250

TUTTA PIASTRA + 4 FUOCHI PIASTRA CM. 37X57 (INCLUSA 1 TESTATA CHIUSURA PIANO MOD.TPA-7)

EN Solid top + 4 burners - Plate 37x57 (included 1 Head end filler strip mod.TPA-7)

DE Kochplatte + 4 Gaskochstellen - Platte 37x57 (inbegriffen 1 Abschluss-Element mod.TPA-7)

FR Toute plaque + 4 brûleurs - Plaque cm. 37x57 (inclus 1 Élément de jonction top mod.TPA-7)

ES **PLACA RADIANTE + 4 FUEGOS - PLACA CM. 37X57 (INCLUIDA 1 CHAPA DE CIERRE PARA TOP MOD.TPA-7)**

cm. 120 x 70,5 x 28h

cm. 123 x 77 x 54h / kg 202 / m³ 0,511

29 kW
24.940 kcal/h

€ 4.724,00

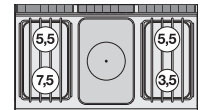
CUOCIPASTA ELETTRICI - TOP

EN ELECTRIC PASTA COOKERS - TOP **DE** ELEKTRO NUDELKOCHER - TOP **FR** CUISEURS DE PÂTES ÉLECTRIQUE - TOP **ES** CUECEPASTAS ELECTRICAS - TOP

CPT-74ET
18100430

CUOCIPASTA TRIFASE LT. 17 VASCA CM. 31X33,5X22H. RUBINETTO SCARICO (CESTI ESCLUSI) (INCLUSA 1 TESTATA CHIUSURA PIANO MOD.TPA-7)

EN Pasta cooker threephase 17 lts. Tank cm. 31x33,5x22h. Drain-tap (BASKETS EXCLUDED) (included 1 Head end filler strip mod.TPA-7)

DE Nudelkocher dreiphasig lt.17 Becken cm. 31x33,5x22h. Ablasshahn (KORB AUSGESCHLOSSEN) (inbegriffen 1 Abschluss-Element mod.TPA-7)

FR Cuiseur à pâtes triphase lt.17 Cuve cm. 31x33,5x22h. Robinet de vidange (PANIERS EXCLUS) (inclus 1 Élément de jonction top mod.TPA-7)

ES **CUECE PASTA TRIFÁSICO LT.17 CUBA CM. 31X33,5X22H. GRIFO DESCARGA (CESTAS EXCLUIDAS) (INCLUIDA 1 CHAPA DE CIERRE PARA TOP MOD.TPA-7)**

cm. 40 x 70,5 x 28h

cm. 43 x 77 x 54h / kg 35 / m³ 0,179

4,1 kW
400V~3N
50/60 Hz

€ 2.119,00

COMBINAZIONI

- Combinations / • Zusammenstellungen
- Combinaisons / • Combinación múltiple



CPT-76ET
 18100630

CUOCIPASTA TRIFASE LT. 25 VASCA CM. 51X31X22H. RUBINETTO SCARICO (CESTI ESCLUSI) (INCLUSA 1 TESTATA CHIUSURA PIANO MOD.TPA-7)

EN Pasta cooker threephase 25 lts. Tank cm. 51x31x22h. Drain-tap (BASKETS EXCLUDED) (included 1 Head end filler strip mod.TPA-7)

DE Nudelkocher dreiphasig lt.25 Becken cm. 51x31x22h. Ablasshahn (KORB AUSGESCHLOSSEN) (inbegriffen 1 Abschluss-Element mod.TPA-7)

FR Cuiseur à pâtes triphase lt.25 Cuve cm. 51x31x22h. Robinet de vidange (PANIERS EXCLUS) (inclus 1 Élément de jonction top mod.TPA-7)

ES **CUECE PASTA TRIFÁSICO LT.25 CUBA CM. 51X31X22H. GRIFO DESCARGA (CESTAS EXCLUIDAS) (INCLUIDA 1 CHAPA DE CIERRE PARA TOP MOD. TPA-7)**

cm. 60 x 70,5 x 28h

cm. 63 x 77 x 54h / kg 45 / m³ 0,262

6,25 kW
 400V~3N
 50/60 Hz

€ 2.421,00
COMBINAZIONI

- Combinations / • Zusammenstellungen
- Combinaisons / • Combinación múltiple

CUOCIPASTA A GAS - TOP

EN GAS PASTA COOKERS - TOP **DE** GAS NUDELKOCHER - TOP **FR** CUISEURS DE PÂTES À GAZ - TOP **ES** **CUECEPASTAS A GAS - TOP**

CPT-74G
 18270450

CUOCIPASTA A GAS CAPACITA' LT. 13 VASCA CM. 31X33,5X18H. RUBINETTO SCARICO (CESTI ESCLUSI) (INCLUSA 1 TESTATA CHIUSURA PIANO MOD.TPA-7)

EN Gas pasta cookers Tank capacity 13 lts. Tank cm. 31x33,5x18h. Drain-tap (BASKETS EXCLUDED) (included 1 Head end filler strip mod.TPA-7)

DE Gas -Nudelkocher Beckeninhalt lt.13 Becken cm. 31x33,5x18h. Ablasshahn (KORB AUSGESCHLOSSEN) (inbegriffen 1 Abschluss-Element mod.TPA-7)

FR Cuiseur à pâtes gaz Cuve lt.13 Cuve cm. 31x33,5x18h. Robinet de vidange (PANIERS EXCLUS) (inclus 1 Élément de jonction top mod.TPA-7)

ES **CUECE PASTA GAS CUBA 13 LT. CUBA CM. 31X33,5X18H. GRIFO DESCARGA (CESTAS EXCLUIDAS) (INCLUIDA 1 CHAPA DE CIERRE PARA TOP MOD.TPA-7)**

cm. 40 x 70,5 x 28h

cm. 43 x 77 x 54h / kg 38 / m³ 0,179

6 kW
 5.160 kcal/h

€ 2.300,00
COMBINAZIONI

- Combinations / • Zusammenstellungen
- Combinaisons / • Combinación múltiple

CPT-76G
 18270650

CUOCIPASTA A GAS CAPACITA' LT. 19 VASCA CM. 51X31X18H. RUBINETTO SCARICO (CESTI ESCLUSI) (INCLUSA 1 TESTATA CHIUSURA PIANO MOD.TPA-7)

EN Gas pasta cookers Tank capacity 19 lts. Tank cm. 51x31x18h. Drain-tap (BASKETS EXCLUDED) (included 1 Head end filler strip mod.TPA-7)

DE Gas -Nudelkocher Beckeninhalt lt. 19 Becken cm. 51x31x18h. Ablasshahn (KORB AUSGESCHLOSSEN) (inbegriffen 1 Abschluss-Element mod.TPA-7)

FR Cuiseur à pâtes gaz Cuve lt.19 Cuve cm. 51x31x18h. Robinet de vidange (PANIERS EXCLUS) (inclus 1 Élément de jonction top mod.TPA-7)

ES **CUECE PASTA GAS CUBA 19 LT. CUBA CM. 51X31X18H. GRIFO DESCARGA (CESTAS EXCLUIDAS) (INCLUIDA 1 CHAPA DE CIERRE PARA TOP MOD. TPA-7)**

cm. 60 x 70,5 x 28h

cm. 63 x 77 x 54h / kg 49 / m³ 0,262

9 kW
 7.740 kcal/h

€ 2.717,00
COMBINAZIONI

- Combinations / • Zusammenstellungen
- Combinaisons / • Combinación múltiple



BAGNOMARIA ELETTRICI - TOP

EN ELECTRIC BAIN MARIE - TOP DE ELEKTRO WASSERBÄDER - TOP FR BAIN MARIE ÉLECTRIQUE - TOP ES BAÑO MARÍA ELECTRICO - TOP

BMT-74EM
18050410

BAGNOMARIA MONOFASE VASCA PER GN 1/1 H.15 (INCLUSA 1 TESTATA CHIUSURA PIANO MOD.TPA-7)

EN Bain marie singlephase - Bowl for GN 1/1 h.15 (included 1 Head end filler strip mod. TPA-7)

DE Wasserbäder einphasig - Becken GN 1/1 h.15 (inbegriffen 1 Abschluss-Element mod.TPA-7)

FR Bain marie monophasé - Cuve GN 1/1 h.15 (inclus 1 Élément de jonction top mod. TPA-7)

ES BAÑO DE MARÍA MONOFÁSICO - CUBA PARA GN 1/1 15H (INCLUIDA 1 CHAPA DE CIERRE PARA TOP MOD.TPA-7)

cm. 40 x 70,5 x 28h

cm. 43 x 77 x 54h / kg 35 / m³ 0,179

2,1 kW
230V~
50/60 Hz

€ 1.494,00

BMT-78ET
18050830

BAGNOMARIA TRIFASE VASCA PER GN 2/1 15H (INCLUSA 1 TESTATA CHIUSURA PIANO MOD.TPA-7)

EN Bain marie threephase - Bowl for GN 2/1 15h (included 1 Head end filler strip mod. TPA-7)

DE Wasserbäder dreiphasig - Becken GN 2/1 15h (inbegriffen 1 Abschluss-Element mod.TPA-7)

FR Bain marie triphasé - Cuve GN 2/1 15h (inclus 1 Élément de jonction top mod.TPA-7)

ES BAÑO DE MARÍA TRIFÁSICO - CUBA PARA GN 2/1 15H (INCLUIDA 1 CHAPA DE CIERRE PARA TOP MOD.TPA-7)

cm. 80 x 70,5 x 28h

cm. 83 x 77 x 54h / kg 54 / m³ 0,345

4,2 kW
400V~2N
230V~3
230V~
50/60 Hz

€ 2.033,00

BAGNOMARIA A GAS - TOP

EN GAS BAIN MARIE - TOP DE GAS WASSERBÄDER - TOP FR BAIN MARIE A GAZ - TOP ES BAÑO MARÍA DE GAS - TOP

BMT-74G
18220450

BAGNOMARIA GAS VASCA PER GN 1/1 H.15 (INCLUSA 1 TESTATA CHIUSURA PIANO MOD. TPA-7)

EN Gas bain-marie - Bowl for GN 1/1 h.15 (included 1 Head end filler strip mod.TPA-7)

DE Gas Wasserbad - Becken GN 1/1 h.15 (inbegriffen 1 Abschluss-Element mod.TPA-7)

FR Bain-marie gaz - Cuve pour GN 1/1 h.15 (inclus 1 Élément de jonction top mod.TPA-7)

ES BAÑO DE MARÍA GAS - CUBA PARA GN 1/1 15H (INCLUIDA 1 CHAPA DE CIERRE PARA TOP MOD.TPA-7)

cm. 40 x 70,5 x 28h

cm. 43 x 77 x 54h / kg 43 / m³ 0,179

3,5 kW
3.010 kcal/h

€ 1.895,00

BMT-78G
18220850

BAGNOMARIA GAS VASCA PER GN 2/1 H.15 (INCLUSA 1 TESTATA CHIUSURA PIANO MOD. TPA-7)

EN Gas bain-marie - Bowl for GN 2/1 h.15 (included 1 Head end filler strip mod.TPA-7)

DE Gas Wasserbad - Becken GN 2/1 h.15 (inbegriffen 1 Abschluss-Element mod.TPA-7)

FR Bain-marie gaz - Cuve pour GN 2/1 h.15 (inclus 1 Élément de jonction top mod.TPA-7)

ES BAÑO DE MARÍA GAS - CUBA PARA GN 2/1 15H (INCLUIDA 1 CHAPA DE CIERRE PARA TOP MOD.TPA-7)

cm. 80 x 70,5 x 28h

cm. 83 x 77 x 54h / kg 61 / m³ 0,345

6,5 kW
5.590 kcal/h

€ 2.600,00

CONTENITORE CALDO INFRAROSSO - TOP

EN ELECTRIC CHIP DUMP WITH INFRARED HEATER - TOP **DE** FRITTENWANNE MIT INFRAROT - TOP **FR** SILO A FRITES AVEC INFRAROUGE - TOP
ES **CONTENEDOR CALIENTE POR INFRARROJO - TOP**

BST-74EM
 18040410



CONTENITORE CALDO CON INFRAROSSO MONOFASE VASCA CM. 30,5X51X16,5H CON FALSO FONDO FORATO (INCLUSA 1 TESTATA CHIUSURA PIANO MOD.TPA-7)

- EN** Fry dump singlephase with infra-red heater. Bowl cm. 30,5x51x16,5h with perforated double bottom (included 1 Head end filler strip mod.TPA-7)
- DE** Frittenwanne Einphasig mit Infrarot-strahler. Becke cm. 30,5x51x16,5h mit gelochtem Bodenrost (inbegriffen 1 Abschluss-Element mod.TPA-7)
- FR** Silo a frites monophasé avec infrarouge. Cuve cm 30,5x51x16,5h avec double-fond perforé. (inclus 1 Élément de jonction top mod.TPA-7)

ES **CONTENEDOR CALIENTE POR INFRARROJO MONOFÁSICO. CUBA CM. 30,5X51X16,5H CON FALSO FONDO AGUJERADO (INCLUIDA 1 CHAPA DE CIERRE PARA TOP MOD.TPA-7)**

- cm. 40 x 70,5 x 28h
- cm. 43 x 77 x 63h / kg 36 / m³ 0,209

⚡ 1,47 kW
 230V~
 50/60 Hz
€ 1.814,00

FRY-TOP ELETTRICI - TOP

EN ELECTRIC GRIDDLE - TOP **DE** ELEKTROGRIDDLEPLATTEN - TOP **FR** FRY-TOP ÉLECTRIQUE - TOP **ES** **FRY-TOP ELECTRICO - TOP**

FTLT-74ET
 18060431



FRY-TOP ELETTRICO LISCIO, PIASTRA CM.36X51 (INCLUSA 1 TESTATA CHIUSURA PIANO MOD.TPA-7)

- EN** Electric Fry-top smooth griddle, plate cm.36x51 (included 1 Head end filler strip mod.TPA-7)
- DE** Griddleplatte elektrische glatt, platte cm.36x51 (inbegriffen 1 Abschluss-Element mod.TPA-7)
- FR** Plaque électriques lisse, plaque cm.36x51 (inclus 1 Élément de jonction top mod.TPA-7)

ES **FRY-TOP ELÉCTRICO LISO, PLANCHA CM.36X51 (INCLUIDA 1 CHAPA DE CIERRE PARA TOP MOD.TPA-7)**

- cm. 40 x 70,5 x 28h
- cm. 43 x 77 x 54h / kg 58 / m³ 0,179

⚡ 5,55 kW
 400V~3N
 230V~3
 50/60 Hz
€ 2.057,00

FTLT-74ETS
 18060434

FRY-TOP ELETTRICO LISCIO CROMATO SUPERCHROME (MOCA APPROVED), PIASTRA CM.36X51 (INCLUSA 1 TESTATA CHIUSURA PIANO MOD.TPA-7)

- EN** Electric Fry-top smooth chromed griddle SUPERCHROME (Moca Approved), plate cm.36x51 (included 1 Head end filler strip mod.TPA-7)
- DE** Griddleplatte elektrische glatt hartverchromt SUPERCHROME (Moca Approved), platte cm.36x51 (inbegriffen 1 Abschluss-Element mod.TPA-7)
- FR** Plaque électriques lisse chromée SUPERCHROME (Moca Approved), plaque cm.36x51 (inclus 1 Élément de jonction top mod.TPA-7)

ES **FRY-TOP ELÉCTRICO LISO CROMADO SUPERCHROME (MOCA APPROVED), PLANCHA CM.36X51 (INCLUIDA 1 CHAPA DE CIERRE PARA TOP MOD.TPA-7)**

- cm. 40 x 70,5 x 28h
- cm. 43 x 77 x 54h / kg 58 / m³ 0,179

⚡ 5,55 kW
 400V~3N
 230V~3
 50/60 Hz
€ 2.416,00

FTLT-74ETSS
 18060430

FRY-TOP ELETTRICO LISCIO CROMO LUCIDO, PIASTRA CM.36X51 (INCLUSA 1 TESTATA CHIUSURA PIANO MOD.TPA-7)

- EN** Electric Fry-top smooth POLISHED CHROME, plate cm.36x51 (included 1 Head end filler strip mod.TPA-7)
- DE** Griddleplatte elektrische glatt POLIERTEM CHROM, platte cm.36x51 (inbegriffen 1 Abschluss-Element mod.TPA-7)
- FR** Plaque électriques lisse CHROME POLI, plaque cm.36x51 (inclus 1 Élément de jonction top mod.TPA-7)

ES **FRY-TOP ELÉCTRICO LISO CROMO PULIDO, PLANCHA CM.36X51 (INCLUIDA 1 CHAPA DE CIERRE PARA TOP MOD.TPA-7)**

- cm. 40 x 70,5 x 28h
- cm. 43 x 77 x 54h / kg 58 / m³ 0,179

⚡ 5,55 kW
 400V~3N
 230V~3
 50/60 Hz
€ 2.416,00

FTRT-74ET

18060433



FRY-TOP ELETTRICO RIGATO, PIASTRA CM.36X51 (INCLUSA 1 TESTATA CHIUSURA PIANO MOD.TPA-7)

- EN** Electric Fry-top grooved griddle, plate cm.36x51 (included 1 Head end filler strip mod.TPA-7)
- DE** Griddleplatte elektrische gerillt, platte cm.36x51 (inbegriffen 1 Abschluss-Element mod.TPA-7)
- FR** Plaque électriques nervurée, plaque cm.36x51 (inclus 1 Élément de jonction top mod.TPA-7)

ES **FRY-TOP ELÉCTRICO ESTRIADO, PLANCHA CM.36X51 (INCLUIDA 1 CHAPA DE CIERRE PARA TOP MOD.TPA-7)**

cm. 40 x 70,5 x 28h

cm. 43 x 77 x 54h / kg 58 / m³ 0,179

5,55 kW
400V~3N
230V~3
50/60 Hz

€ 2.223,00**FTRT-74ETS**

18060436

FRY-TOP ELETTRICO RIGATO CROMATO SUPERCHROME (MOCA APPROVED), PIASTRA CM.36X51 (INCLUSA 1 TESTATA CHIUSURA PIANO MOD.TPA-7)

- EN** Electric Fry-top grooved chromed griddle SUPERCHROME (Moca Approved), plate cm.36x51 (included 1 Head end filler strip mod.TPA-7)
- DE** Griddleplatte elektrische gerillt hartverchromt SUPERCHROME (Moca Approved), platte cm.36x51 (inbegriffen 1 Abschluss-Element mod.TPA-7)
- FR** Plaque électriques nervurée chromée SUPERCHROME (Moca Approved), plaque cm.36x51 (inclus 1 Élément de jonction top mod.TPA-7)

ES **FRY-TOP ELÉCTRICO ESTRIADO CROMADO SUPERCHROME (MOCA APPROVED), PLANCHA CM.36X51 (INCLUIDA 1 CHAPA DE CIERRE PARA TOP MOD.TPA-7)**

cm. 40 x 70,5 x 28h

cm. 43 x 77 x 54h / kg 58 / m³ 0,179

5,55 kW
400V~3N
230V~3
50/60 Hz

€ 2.574,00**FTLT-76ET**

18060631



FRY-TOP ELETTRICO LISCIO, PIASTRA CM.56X51 (INCLUSA 1 TESTATA CHIUSURA PIANO MOD.TPA-7)

- EN** Electric Fry-top smooth griddle, plate cm.56x51 (included 1 Head end filler strip mod.TPA-7)
- DE** Griddleplatte elektrische glatt, platte cm.56x51 (inbegriffen 1 Abschluss-Element mod.TPA-7)
- FR** Plaque électriques lisse, plaque cm.56x51 (inclus 1 Élément de jonction top mod.TPA-7)

ES **FRY-TOP ELÉCTRICO LISO, PLANCHA CM.56X51 (INCLUIDA 1 CHAPA DE CIERRE PARA TOP MOD.TPA-7)**

cm. 60 x 70,5 x 28h

cm. 63 x 77 x 54h / kg 67 / m³ 0,262

7,4 kW
400V~3N
50/60 Hz

€ 2.354,00**FTLT-76ETS**

18060634

FRY-TOP ELETTRICO LISCIO CROMATO SUPERCHROME (MOCA APPROVED), PIASTRA CM.56X51 (INCLUSA 1 TESTATA CHIUSURA PIANO MOD.TPA-7)

- EN** Electric Fry-top smooth chromed griddle SUPERCHROME (Moca Approved), plate cm.56x51 (included 1 Head end filler strip mod.TPA-7)
- DE** Griddleplatte elektrische glatt hartverchromt SUPERCHROME (Moca Approved), platte cm.56x51 (inbegriffen 1 Abschluss-Element mod.TPA-7)
- FR** Plaque électriques lisse chromée SUPERCHROME (Moca Approved), plaque cm.56x51 (inclus 1 Élément de jonction top mod.TPA-7)

ES **FRY-TOP ELÉCTRICO LISO CROMADO SUPERCHROME (MOCA APPROVED), PLANCHA CM.56X51 (INCLUIDA 1 CHAPA DE CIERRE PARA TOP MOD.TPA-7)**

cm. 60 x 70,5 x 28h

cm. 63 x 77 x 54h / kg 67 / m³ 0,262

7,4 kW
400V~3N
50/60 Hz

€ 2.947,00**FTLT-76ETSS**

18060630

FRY-TOP ELETTRICO LISCIO CROMO LUCIDO, PIASTRA CM.56X51 (INCLUSA 1 TESTATA CHIUSURA PIANO MOD.TPA-7)

- EN** Electric Fry-top smooth POLISHED CHROME, plate cm.56x51 (included 1 Head end filler strip mod.TPA-7)
- DE** Griddleplatte elektrische glatt POLIERTEM CHROM, platte cm.56x51 (inbegriffen 1 Abschluss-Element mod.TPA-7)
- FR** Plaque électriques lisse CHROME POLI, plaque cm.56x51 (inclus 1 Élément de jonction top mod.TPA-7)

ES **FRY-TOP ELÉCTRICO LISO CROMO PULIDO, PLANCHA CM.56X51 (INCLUIDA 1 CHAPA DE CIERRE PARA TOP MOD.TPA-7)**

cm. 60 x 70,5 x 28h

cm. 63 x 77 x 54h / kg 67 / m³ 0,262

7,4 kW
400V~3N
50/60 Hz

€ 2.947,00

FTLRT-76ET

18060632



FRY-TOP ELETTRICO 1/2 RIGATO + 1/2 LISCIO, PIASTRA CM.56X51 (INCLUSA 1 TESTATA CHIUSURA PIANO MOD.TPA-7)

EN Electric Fry-top 1/2 grooved + 1/2 smooth, plate cm.56x51 (included 1 Head end filler strip mod.TPA-7)

DE Griddleplatte elektrische 1/2 gerillt + 1/2 glatt, platte cm.56x51 (inbegriffen 1 Abschluss-Element mod.TPA-7)

FR Plaque électriques 1/2 nervurée + 1/2 lisse, plaque cm.56x51 (inclus 1 Élément de jonction top mod.TPA-7)

ES **FRY-TOP ELÉCTRICO 1/2 ESTRIADO + 1/2 LISO, PLANCHA CM.56X51 (INCLUIDA 1 CHAPA DE CIERRE PARA TOP MOD.TPA-7)**

cm. 60 x 70,5 x 28h

cm. 63 x 77 x 54h / kg 67 / m³ 0,262

7,4 kW
400V~3N
50/60 Hz

€ 2.538,00

FTLRT-76ETS

18060635

FRY-TOP ELETTRICO 1/2 RIGATO + 1/2 LISCIO CROMATO SUPERCHROME (MOCA APPROVED), PIASTRA CM.56X51 (INCLUSA 1 TESTATA CHIUSURA PIANO MOD.TPA-7)

EN Electric Fry-top 1/2 grooved + 1/2 smooth chromed griddle SUPERCHROME (Moca Approved), plate cm.56x51 (included 1 Head end filler strip mod.TPA-7)

DE Griddleplatte elektrische 1/2 gerillt + 1/2 glatt hartverchromt SUPERCHROME (Moca Approved), platte cm.56x51 (inbegriffen 1 Abschluss-Element mod.TPA-7)

FR Plaque électriques 1/2 nervurée + 1/2 lisse chromée SUPERCHROME (Moca Approved), plaque cm.56x51 (inclus 1 Élément de jonction top mod.TPA-7)

ES **FRY-TOP ELÉCTRICO 1/2 ESTRIADO + 1/2 LISO CROMADO SUPERCHROME (MOCA APPROVED), PLANCHA CM.56X51 (INCLUIDA 1 CHAPA DE CIERRE PARA TOP MOD.TPA-7)**

cm. 60 x 70,5 x 28h

cm. 63 x 77 x 54h / kg 67 / m³ 0,262

7,4 kW
400V~3N
50/60 Hz

€ 3.126,00

FTRT-76ET

18060633



FRY-TOP ELETTRICO RIGATO, PIASTRA CM.56X51 (INCLUSA 1 TESTATA CHIUSURA PIANO MOD.TPA-7)

EN Electric Fry-top grooved griddle, plate cm.56x51 (included 1 Head end filler strip mod.TPA-7)

DE Griddleplatte elektrische gerillt, platte cm.56x51 (inbegriffen 1 Abschluss-Element mod.TPA-7)

FR Plaque électriques nervurée, plaque cm.56x51 (inclus 1 Élément de jonction top mod.TPA-7)

ES **FRY-TOP ELÉCTRICO ESTRIADO, PLANCHA CM.56X51 (INCLUIDA 1 CHAPA DE CIERRE PARA TOP MOD.TPA-7)**

cm. 60 x 70,5 x 28h

cm. 63 x 77 x 54h / kg 67 / m³ 0,262

7,4 kW
400V~3N
50/60 Hz

€ 2.721,00

FTRT-76ETS

18060636

FRY-TOP ELETTRICO RIGATO CROMATO SUPERCHROME (MOCA APPROVED), PIASTRA CM.56X51 (INCLUSA 1 TESTATA CHIUSURA PIANO MOD.TPA-7)

EN Electric Fry-top grooved chromed griddle SUPERCHROME (Moca Approved), plate cm.56x51 (included 1 Head end filler strip mod.TPA-7)

DE Griddleplatte elektrische gerillt hartverchromt SUPERCHROME (Moca Approved), platte cm.56x51 (inbegriffen 1 Abschluss-Element mod.TPA-7)

FR Plaque électriques nervurée chromée SUPERCHROME (Moca Approved), plaque cm.56x51 (inclus 1 Élément de jonction top mod.TPA-7)

ES **FRY-TOP ELÉCTRICO ESTRIADO CROMADO SUPERCHROME (MOCA APPROVED), PLANCHA CM.56X51 (INCLUIDA 1 CHAPA DE CIERRE PARA TOP MOD.TPA-7)**

cm. 60 x 70,5 x 28h

cm. 63 x 77 x 54h / kg 67 / m³ 0,262

7,4 kW
400V~3N
50/60 Hz

€ 3.312,00

FTLT-78ET
18060831

FRY-TOP ELETTRICO LISCIO, PIASTRA CM.76X51 - 2 ZONE DI COTTURA (INCLUSA 1 TESTATA CHIUSURA PIANO MOD.TPA-7)

EN Electric Fry-top smooth griddle, plate cm.76x51 - 2 cooking areas (included 1 Head end filler strip mod.TPA-7)

DE Griddleplatte elektrische glatt, platte cm.76x51 - 2 Heizzonen (inbegriffen 1 Abschluss-Element mod.TPA-7)

FR Plaque électriques lisse, plaque cm.76x51 - 2 zones de cuisson (inclus 1 Élément de jonction top mod.TPA-7)

ES **FRY-TOP ELÉCTRICO LISO, PLANCHA CM.76X51 - 2 ZONAS DE COCCIÓN (INCLUIDA 1 CHAPA DE CIERRE PARA TOP MOD.TPA-7)**

cm. 80 x 70,5 x 28h

cm. 83 x 77 x 54h / kg 103 / m³ 0,345

11,1 kW **€ 3.059,00**

400V~3N

230V~3

50/60 Hz

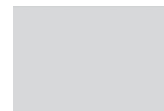
FTLT-78ETS
18060834

FRY-TOP ELETTRICO LISCIO CROMATO SUPERCHROME (MOCA APPROVED), PIASTRA CM.76X51 - 2 ZONE DI COTTURA (INCLUSA 1 TESTATA CHIUSURA PIANO MOD.TPA-7)

EN Electric Fry-top smooth chromed griddle SUPERCHROME (Moca Approved), plate cm.76x51 - 2 cooking areas (included 1 Head end filler strip mod.TPA-7)

DE Griddleplatte elektrische glatt hartverchromt SUPERCHROME (Moca Approved), platte cm.76x51 - 2 Heizzonen (inbegriffen 1 Abschluss-Element mod.TPA-7)

FR Plaque électriques lisse chromée SUPERCHROME (Moca Approved), plaque cm.76x51 - 2 zones de cuisson (inclus 1 Élément de jonction top mod.TPA-7)

ES **FRY-TOP ELÉCTRICO LISO CROMADO SUPERCHROME (MOCA APPROVED), PLANCHA CM.76X51 - 2 ZONAS DE COCCIÓN (INCLUIDA 1 CHAPA DE CIERRE PARA TOP MOD.TPA-7)**

cm. 80 x 70,5 x 28h

cm. 83 x 77 x 54h / kg 103 / m³ 0,345

11,1 kW **€ 3.815,00**

400V~3N

230V~3

50/60 Hz

FTLT-78ETSS
18060830

FRY-TOP ELETTRICO LISCIO CROMO LUCIDO, PIASTRA CM.76X51 - 2 ZONE DI COTTURA (INCLUSA 1 TESTATA CHIUSURA PIANO MOD.TPA-7)

EN Electric Fry-top smooth POLISHED CHROME, plate cm.76x51 - 2 cooking areas (included 1 Head end filler strip mod.TPA-7)

DE Griddleplatte elektrische glatt POLIERTEM CHROM, platte cm.76x51 - 2 Heizzonen (inbegriffen 1 Abschluss-Element mod.TPA-7)

FR Plaque électriques lisse CHROME POLI, plaque cm.76x51 - 2 zones de cuisson (inclus 1 Élément de jonction top mod.TPA-7)

ES **FRY-TOP ELÉCTRICO LISO CROMO PULIDO, PLANCHA CM.76X51 - 2 ZONAS DE COCCIÓN (INCLUIDA 1 CHAPA DE CIERRE PARA TOP MOD.TPA-7)**

cm. 80 x 70,5 x 28h

cm. 83 x 77 x 54h / kg 103 / m³ 0,345

11,1 kW **€ 3.815,00**

400V~3N

230V~3

50/60 Hz

FTLRT-78ET
18060832

FRY-TOP ELETTRICO 1/2 RIGATO + 1/2 LISCIO, PIASTRA CM.76X51 - 2 ZONE DI COTTURA (INCLUSA 1 TESTATA CHIUSURA PIANO MOD.TPA-7)

EN Electric Fry-top 1/2 grooved + 1/2 smooth, plate cm.76x51 - 2 cooking areas (included 1 Head end filler strip mod.TPA-7)

DE Griddleplatte elektrische 1/2 gerillt + 1/2 glatt, platte cm.76x51 - 2 Heizzonen (inbegriffen 1 Abschluss-Element mod.TPA-7)

FR Plaque électriques 1/2 nervurée + 1/2 lisse, plaque cm.76x51 - 2 zones de cuisson (inclus 1 Élément de jonction top mod.TPA-7)

ES **FRY-TOP ELÉCTRICO 1/2 ESTRIADO + 1/2 LISO, PLANCHA CM.76X51 - 2 ZONAS DE COCCIÓN (INCLUIDA 1 CHAPA DE CIERRE PARA TOP MOD.TPA-7)**

cm. 80 x 70,5 x 28h

cm. 83 x 77 x 54h / kg 103 / m³ 0,345

11,1 kW **€ 3.299,00**

400V~3N

230V~3

50/60 Hz

FTLRT-78ETS
18060835

FRY-TOP ELETTRICO 1/2 RIGATO + 1/2 LISCIO CROMATO SUPERCHROME (MOCA APPROVED), PIASTRA CM.76X51 - 2 ZONE DI COTTURA (INCLUSA 1 TESTATA CHIUSURA PIANO MOD.TPA-7)

EN Electric Fry-top 1/2 grooved + 1/2 smooth chromed griddle SUPERCHROME (Moca Approved), plate cm.76x51 - 2 cooking areas (included 1 Head end filler strip mod.TPA-7)

DE Griddleplatte elektrische 1/2 gerillt + 1/2 glatt hartverchromt SUPERCHROME (Moca Approved), platte cm.76x51 - 2 Heizzonen (inbegriffen 1 Abschluss-Element mod.TPA-7)

FR Plaque électriques 1/2 nervurée + 1/2 lisse chromée SUPERCHROME (Moca Approved), plaque cm.76x51 - 2 zones de cuisson (inclus 1 Élément de jonction top mod.TPA-7)

ES **FRY-TOP ELÉCTRICO 1/2 ESTRIADO + 1/2 LISO CROMADO SUPERCHROME (MOCA APPROVED), PLANCHA CM.76X51 - 2 ZONAS DE COCCIÓN (INCLUIDA 1 CHAPA DE CIERRE PARA TOP MOD.TPA-7)**

cm. 80 x 70,5 x 28h

cm. 83 x 77 x 54h / kg 103 / m³ 0,345

11,1 kW **€ 4.047,00**

400V~3N

230V~3

50/60 Hz



FTRT-78ET
 18060833

FRY-TOP ELETTRICO RIGATO, PIASTRA CM.76X51 - 2 ZONE DI COTTURA (INCLUSA 1 TESTATA CHIUSURA PIANO MOD.TPA-7)

EN Electric Fry-top grooved griddle, plate cm.76x51 - 2 cooking areas (included 1 Head end filler strip mod.TPA-7)

DE Griddleplatte elektrische gerillt, platte cm.76x51 - 2 Heizzonen (inbegriffen 1 Abschluss-Element mod.TPA-7)

FR Plaque électriques nervurée, plaque cm.76x51 - 2 zones de cuisson (inclus 1 Élément de jonction top mod.TPA-7)

ES **FRY-TOP ELÉCTRICO ESTRIADO, PLANCHA CM.76X51 - 2 ZONAS DE COCCIÓN (INCLUIDA 1 CHAPA DE CIERRE PARA TOP MOD.TPA-7)**

cm. 80 x 70,5 x 28h

cm. 83 x 77 x 54h / kg 103 / m³ 0,345

11,1 kW
 400V~3N
 230V~3
 50/60 Hz

€ 3.479,00

FTRT-78ETS
 18060836

FRY-TOP ELETTRICO RIGATO CROMATO SUPERCHROME (MOCA APPROVED), PIASTRA CM.76X51 - 2 ZONE DI COTTURA (INCLUSA 1 TESTATA CHIUSURA PIANO MOD.TPA-7)

EN Electric Fry-top grooved chromed griddle SUPERCHROME (Moca Approved), plate cm.76x51 - 2 cooking areas (included 1 Head end filler strip mod.TPA-7)

DE Griddleplatte elektrische gerillt hartverchromt SUPERCHROME (Moca Approved), platte cm.76x51 - 2 Heizzonen (inbegriffen 1 Abschluss-Element mod.TPA-7)

FR Plaque électriques nervurée chromée SUPERCHROME (Moca Approved), plaque cm.76x51 - 2 zones de cuisson (inclus 1 Élément de jonction top mod.TPA-7)

ES **FRY-TOP ELÉCTRICO ESTRIADO CROMADO SUPERCHROME (MOCA APPROVED), PLANCHA CM.76X51 - 2 ZONAS DE COCCIÓN (INCLUIDA 1 CHAPA DE CIERRE PARA TOP MOD.TPA-7)**

cm. 80 x 70,5 x 28h

cm. 83 x 77 x 54h / kg 103 / m³ 0,345

11,1 kW
 400V~3N
 230V~3
 50/60 Hz

€ 4.272,00

FTLT-712ET
 18061231

FRY-TOP ELETTRICO LISCIO, PIASTRA CM.116X51 - 2 ZONE DI COTTURA (INCLUSA 1 TESTATA CHIUSURA PIANO MOD.TPA-7)

EN Electric Fry-top smooth griddle, plate cm.116x51 - 2 cooking areas (included 1 Head end filler strip mod.TPA-7)

DE Griddleplatte elektrische glatt, platte cm.116x51 - 2 Heizzonen (inbegriffen 1 Abschluss-Element mod.TPA-7)

FR Plaque électriques lisse, plaque cm.116x51 - 2 zones de cuisson (inclus 1 Élément de jonction top mod.TPA-7)

ES **FRY-TOP ELÉCTRICO LISO, PLANCHA CM.116X51 - 2 ZONAS DE COCCIÓN (INCLUIDA 1 CHAPA DE CIERRE PARA TOP MOD.TPA-7)**

cm. 120 x 70,5 x 28h

cm. 123 x 77 x 54h / kg 114 / m³ 0,511

14,8 kW
 400V~3N
 50/60 Hz

€ 4.330,00

FTLT-712ETS
 18061234

FRY-TOP ELETTRICO LISCIO CROMATO SUPERCHROME (MOCA APPROVED), PIASTRA CM.116X51 - 2 ZONE DI COTTURA (INCLUSA 1 TESTATA CHIUSURA PIANO MOD.TPA-7)

EN Electric Fry-top smooth chromed griddle SUPERCHROME (Moca Approved), plate cm.116x51 - 2 cooking areas (included 1 Head end filler strip mod.TPA-7)

DE Griddleplatte elektrische glatt hartverchromt SUPERCHROME (Moca Approved), platte cm.116x51 - 2 Heizzonen (inbegriffen 1 Abschluss-Element mod.TPA-7)

FR Plaque électriques lisse chromée SUPERCHROME (Moca Approved), plaque cm.116x51 - 2 zones de cuisson (inclus 1 Élément de jonction top mod.TPA-7)

ES **FRY-TOP ELÉCTRICO LISO CROMADO SUPERCHROME (MOCA APPROVED), PLANCHA CM.116X51 - 2 ZONAS DE COCCIÓN (INCLUIDA 1 CHAPA DE CIERRE PARA TOP MOD.TPA-7)**

cm. 120 x 70,5 x 28h

cm. 123 x 77 x 54h / kg 114 / m³ 0,511

14,8 kW
 400V~3N
 50/60 Hz

€ 5.396,00

FTLRT-712ET

18061232



FRY-TOP ELETTRICO 1/2 RIGATO + 1/2 LISCIO, PIASTRA CM.116X51 - 2 ZONE DI COTTURA (INCLUSA 1 TESTATA CHIUSURA PIANO MOD.TPA-7)

- EN** Electric Fry-top 1/2 grooved + 1/2 smooth, plate cm.116x51 - 2 cooking areas (included 1 Head end filler strip mod.TPA-7)
- DE** Griddleplatte elektrische 1/2 gerillt + 1/2 glatt, platte cm.116x51 - 2 Heizzonen (inbegriffen 1 Abschluss-Element mod.TPA-7)
- FR** Plaque électriques 1/2 nervurée + 1/2 lisse, plaque cm.116x51 - 2 zones de cuisson (inclus 1 Élément de jonction top mod.TPA-7)
- ES** **FRY-TOP ELÉCTRICO 1/2 ESTRIADO + 1/2 LISO, PLANCHA CM.116X51 - 2 ZONAS DE COCCIÓN (INCLUIDA 1 CHAPA DE CIERRE PARA TOP MOD. TPA-7)**

cm. 120 x 70,5 x 28h

cm. 123 x 77 x 54h / kg 114 / m³ 0,511

€ 4.544,00
 14,8 kW
 400V~3N
 50/60 Hz

**FTLRT-712ETS**

18061235

FRY-TOP ELETTRICO 1/2 RIGATO + 1/2 LISCIO CROMATO SUPERCHROME (MOCA APPROVED), PIASTRA CM.116X51 - 2 ZONE DI COTTURA (INCLUSA 1 TESTATA CHIUSURA PIANO MOD.TPA-7)

- EN** Electric Fry-top 1/2 grooved + 1/2 smooth chromed griddle SUPERCHROME (Moca Approved), plate cm.116x51 - 2 cooking areas (included 1 Head end filler strip mod. TPA-7)
- DE** Griddleplatte elektrische 1/2 gerillt + 1/2 glatt hartverchromt SUPERCHROME (Moca Approved), platte cm.116x51 - 2 Heizzonen (inbegriffen 1 Abschluss-Element mod.TPA-7)
- FR** Plaque électriques 1/2 nervurée + 1/2 lisse chromée SUPERCHROME (Moca Approved), plaque cm.116x51 - 2 zones de cuisson (inclus 1 Élément de jonction top mod.TPA-7)
- ES** **FRY-TOP ELÉCTRICO 1/2 ESTRIADO + 1/2 LISO CROMADO SUPERCHROME (MOCA APPROVED), PLANCHA CM.116X51 - 2 ZONAS DE COCCIÓN (INCLUIDA 1 CHAPA DE CIERRE PARA TOP MOD.TPA-7)**

cm. 120 x 70,5 x 28h

cm. 123 x 77 x 54h / kg 114 / m³ 0,511

€ 5.722,00
 14,8 kW
 400V~3N
 50/60 Hz

**FTRT-712ET**

18061233



FRY-TOP ELETTRICO RIGATO, PIASTRA CM.116X51 - 2 ZONE DI COTTURA (INCLUSA 1 TESTATA CHIUSURA PIANO MOD.TPA-7)

- EN** Electric Fry-top grooved griddle, plate cm.116x51 - 2 cooking areas (included 1 Head end filler strip mod.TPA-7)
- DE** Griddleplatte elektrische gerillt, platte cm.116x51 - 2 Heizzonen (inbegriffen 1 Abschluss-Element mod.TPA-7)
- FR** Plaque électriques nervurée, plaque cm.116x51 - 2 zones de cuisson (inclus 1 Élément de jonction top mod.TPA-7)
- ES** **FRY-TOP ELÉCTRICO ESTRIADO, PLANCHA CM.116X51 - 2 ZONAS DE COCCIÓN (INCLUIDA 1 CHAPA DE CIERRE PARA TOP MOD.TPA-7)**

cm. 120 x 70,5 x 28h

cm. 123 x 77 x 54h / kg 114 / m³ 0,511

€ 4.771,00
 14,8 kW
 400V~3N
 50/60 Hz

**FTRT-712ETS**

18061236

FRY-TOP ELETTRICO RIGATO CROMATO SUPERCHROME (MOCA APPROVED), PIASTRA CM.116X51 - 2 ZONE DI COTTURA (INCLUSA 1 TESTATA CHIUSURA PIANO MOD.TPA-7)

- EN** Electric Fry-top grooved chromed griddle SUPERCHROME (Moca Approved), plate cm.116x51 - 2 cooking areas (included 1 Head end filler strip mod.TPA-7)
- DE** Griddleplatte elektrische gerillt hartverchromt SUPERCHROME (Moca Approved), platte cm.116x51 - 2 Heizzonen (inbegriffen 1 Abschluss-Element mod.TPA-7)
- FR** Plaque électriques nervurée chromée SUPERCHROME (Moca Approved), plaque cm.116x51 - 2 zones de cuisson (inclus 1 Élément de jonction top mod.TPA-7)
- ES** **FRY-TOP ELÉCTRICO ESTRIADO CROMADO SUPERCHROME (MOCA APPROVED), PLANCHA CM.116X51 - 2 ZONAS DE COCCIÓN (INCLUIDA 1 CHAPA DE CIERRE PARA TOP MOD.TPA-7)**

cm. 120 x 70,5 x 28h

cm. 123 x 77 x 54h / kg 114 / m³ 0,511

€ 6.142,00
 14,8 kW
 400V~3N
 50/60 Hz



FTLT-712ET3

1806123B



FRY-TOP ELETTRICO LISCIO, PIASTRA CM.116X51 - 3 ZONE DI COTTURA (INCLUSA 1 TESTATA CHIUSURA PIANO MOD.TPA-7)

EN Electric Fry-top smooth griddle, plate cm.116x51 - 3 cooking areas (included 1 Head end filler strip mod.TPA-7)

DE Griddleplatte elektrische glatt, platte cm.116x51 - 3 Heizzonen (inbegriffen 1 Abschluss-Element mod.TPA-7)

FR Plaque électriques lisse, plaque cm.116x51 - 3 zones de cuisson (inclus 1 Élément de jonction top mod.TPA-7)

ES **FRY-TOP ELÉCTRICO LISO, PLANCHA CM.116X51 - 3 ZONAS DE COCCIÓN (INCLUIDA 1 CHAPA DE CIERRE PARA TOP MOD.TPA-7)**

cm. 120 x 70,5 x 28h

cm. 123 x 77 x 54h / kg 114 / m³ 0,511

16,65 kW
400V~3N
50/60 Hz

€ 4.911,00

FTLT-712ETS3

1806123E

FRY-TOP ELETTRICO LISCIO CROMATO SUPERCHROME (MOCA APPROVED), PIASTRA CM.116X51 - 3 ZONE DI COTTURA (INCLUSA 1 TESTATA CHIUSURA PIANO MOD.TPA-7)

EN Electric Fry-top smooth chromed griddle SUPERCHROME (Moca Approved), plate cm.116x51 - 3 cooking areas (included 1 Head end filler strip mod.TPA-7)

DE Griddleplatte elektrische glatt hartverchromt SUPERCHROME (Moca Approved), platte cm.116x51 - 3 Heizzonen (inbegriffen 1 Abschluss-Element mod.TPA-7)

FR Plaque électriques lisse chromée SUPERCHROME (Moca Approved), plaque cm.116x51 - 3 zones de cuisson (inclus 1 Élément de jonction top mod.TPA-7)

ES **FRY-TOP ELÉCTRICO LISO CROMADO SUPERCHROME (MOCA APPROVED), PLANCHA CM.116X51 - 3 ZONAS DE COCCIÓN (INCLUIDA 1 CHAPA DE CIERRE PARA TOP MOD.TPA-7)**

cm. 120 x 70,5 x 28h

cm. 123 x 77 x 54h / kg 114 / m³ 0,511

16,65 kW
400V~3N
50/60 Hz

€ 5.811,00

FTLT-712ETSS3

1806123Y

FRY-TOP ELETTRICO LISCIO CROMO LUCIDO, PIASTRA CM.116X51 - 3 ZONE DI COTTURA (INCLUSA 1 TESTATA CHIUSURA PIANO MOD.TPA-7)

EN Electric Fry-top smooth POLISHED CHROME, plate cm.116x51 - 3 cooking areas (included 1 Head end filler strip mod.TPA-7)

DE Griddleplatte elektrische glatt POLIERTEM CHROM, platte cm.116x51 - 3 Heizzonen (inbegriffen 1 Abschluss-Element mod.TPA-7)

FR Plaque électriques lisse CHROME POLI, plaque cm.116x51 - 3 zones de cuisson (inclus 1 Élément de jonction top mod.TPA-7)

ES **FRY-TOP ELÉCTRICO LISO CROMO PULIDO, PLANCHA CM.116X51 - 3 ZONAS DE COCCIÓN (INCLUIDA 1 CHAPA DE CIERRE PARA TOP MOD.TPA-7)**

cm. 120 x 70,5 x 28h

cm. 123 x 77 x 54h / kg 114 / m³ 0,511

16,65 kW
400V~3N
50/60 Hz

€ 5.811,00

FTLRT-712ET3

1806123C



FRY-TOP ELETTRICO 1/3 RIGATO + 2/3 LISCIO, PIASTRA CM.116X51 - 3 ZONE DI COTTURA (INCLUSA 1 TESTATA CHIUSURA PIANO MOD.TPA-7)

EN Electric Fry-top 1/3 grooved + 2/3 smooth, plate cm.116x51 - 3 cooking areas (included 1 Head end filler strip mod.TPA-7)

DE Griddleplatte elektrische 1/3 gerillt + 2/3 glatt, platte cm.116x51 - 3 Heizzonen (inbegriffen 1 Abschluss-Element mod.TPA-7)

FR Plaque électriques 1/3 nervurée + 2/3 lisse, plaque cm.116x51 - 3 zones de cuisson (inclus 1 Élément de jonction top mod.TPA-7)

ES **FRY-TOP ELÉCTRICO 1/3 ESTRIADO + 2/3 LISO, PLANCHA CM.116X51 - 3 ZONAS DE COCCIÓN (INCLUIDA 1 CHAPA DE CIERRE PARA TOP MOD.TPA-7)**

cm. 120 x 70,5 x 28h

cm. 123 x 77 x 54h / kg 114 / m³ 0,511

16,65 kW
400V~3N
50/60 Hz

€ 5.046,00

FTLRT-712ETS3

1806123F

FRY-TOP ELETTRICO 1/3 RIGATO + 2/3 LISCIO CROMATO SUPERCHROME (MOCA APPROVED), PIASTRA CM.116X51 - 3 ZONE DI COTTURA (INCLUSA 1 TESTATA CHIUSURA PIANO MOD.TPA-7)

EN Electric Fry-top 1/3 grooved + 2/3 smooth chromed griddle SUPERCHROME (Moca Approved), plate cm.116x51 - 3 cooking areas (included 1 Head end filler strip mod.TPA-7)

DE Griddleplatte elektrische 1/3 gerillt + 2/3 glatt hartverchromt SUPERCHROME (Moca Approved), platte cm.116x51 - 3 Heizzonen (inbegriffen 1 Abschluss-Element mod.TPA-7)

FR Plaque électriques 1/3 nervurée + 2/3 lisse chromée SUPERCHROME (Moca Approved), plaque cm.116x51 - 3 zones de cuisson (inclus 1 Élément de jonction top mod.TPA-7)

ES **FRY-TOP ELÉCTRICO 1/3 ESTRIADO + 2/3 LISO CROMADO SUPERCHROME (MOCA APPROVED), PLANCHA CM.116X51 - 3 ZONAS DE COCCIÓN (INCLUIDA 1 CHAPA DE CIERRE PARA TOP MOD.TPA-7)**

cm. 120 x 70,5 x 28h

cm. 123 x 77 x 54h / kg 114 / m³ 0,511

16,65 kW
400V~3N
50/60 Hz

€ 6.026,00

FRY-TOP A GAS - TOP

EN GAS GRIDDLE - TOP DE GASGRIDDLEPLATTEN - TOP FR FRY-TOP À GAZ - TOP ES FRY-TOP A GAS - TOP

FTLT-74G

18230451



FRY-TOP GAS LISCIO, PIASTRA CM.36X51 (INCLUSA 1 TESTATA CHIUSURA PIANO MOD. TPA-7)

EN Gas Fry-top smooth griddle, plate cm.36x51 (included 1 Head end filler strip mod. TPA-7)

DE Gas-griddleplatte glatt, platte cm.36x51 (inbegriffen 1 Abschluss-Element mod. TPA-7)

FR Plaque gaz lisse, plaque cm.36x51 (inclus 1 Élément de jonction top mod.TPA-7)

ES **FRY-TOP GAS LISO, PLANCHA CM.36X51 (INCLUIDA 1 CHAPA DE CIERRE PARA TOP MOD.TPA-7)**

cm. 40 x 70,5 x 28h

cm. 43 x 77 x 54h / kg 63 / m³ 0,179

7 kW
6.020 kcal/h

€ 2.024,00

FTLT-74GS

18230454

FRY-TOP GAS LISCIO CROMATO SUPERCHROME (MOCA APPROVED), PIASTRA CM.36X51 (INCLUSA 1 TESTATA CHIUSURA PIANO MOD.TPA-7)

EN Gas Fry-top smooth chromed griddle SUPERCHROME (Moca Approved), plate cm.36x51 (included 1 Head end filler strip mod.TPA-7)

DE Gas-griddleplatte glatt hartverchromt SUPERCHROME (Moca Approved), platte cm.36x51 (inbegriffen 1 Abschluss-Element mod.TPA-7)

FR Plaque gaz lisse chromée SUPERCHROME (Moca Approved), plaque cm.36x51 (inclus 1 Élément de jonction top mod.TPA-7)

ES **FRY-TOP GAS LISO CROMADO SUPERCHROME (MOCA APPROVED), PLANCHA CM.36X51 (INCLUIDA 1 CHAPA DE CIERRE PARA TOP MOD.TPA-7)**

cm. 40 x 70,5 x 28h

cm. 43 x 77 x 54h / kg 63 / m³ 0,179

7 kW
6.020 kcal/h

€ 2.520,00

FTLT-74GSS

18230450

FRY-TOP GAS LISCIO CROMO LUCIDO, PIASTRA CM.36X51 (INCLUSA 1 TESTATA CHIUSURA PIANO MOD.TPA-7)

EN Gas Fry-top smooth POLISHED CHROME, plate cm.36x51 (included 1 Head end filler strip mod.TPA-7)

DE Gas-griddleplatte glatt POLIERTEM CHROM, platte cm.36x51 (inbegriffen 1 Abschluss-Element mod.TPA-7)

FR Plaque gaz lisse CHROME POLI, plaque cm.36x51 (inclus 1 Élément de jonction top mod.TPA-7)

ES **FRY-TOP GAS LISO CROMO PULIDO, PLANCHA CM.36X51 (INCLUIDA 1 CHAPA DE CIERRE PARA TOP MOD.TPA-7)**

cm. 40 x 70,5 x 28h

cm. 43 x 77 x 54h / kg 63 / m³ 0,179

7 kW
6.020 kcal/h

€ 2.520,00

FRTR-74G

18230453



FRY-TOP GAS RIGATO, PIASTRA CM.36X51 (INCLUSA 1 TESTATA CHIUSURA PIANO MOD. TPA-7)

EN Gas Fry-top grooved griddle, plate cm.36x51 (included 1 Head end filler strip mod. TPA-7)

DE Gas-griddleplatte gerillt, platte cm.36x51 (inbegriffen 1 Abschluss-Element mod. TPA-7)

FR Plaque gaz nervurée, plaque cm.36x51 (inclus 1 Élément de jonction top mod.TPA-7)

ES **FRY-TOP GAS ESTRIADO, PLANCHA CM.36X51 (INCLUIDA 1 CHAPA DE CIERRE PARA TOP MOD.TPA-7)**

cm. 40 x 70,5 x 28h

cm. 43 x 77 x 54h / kg 63 / m³ 0,179

7 kW
6.020 kcal/h

€ 2.246,00

FRTR-74GS

18230456

FRY-TOP GAS RIGATO CROMATO SUPERCHROME (MOCA APPROVED), PIASTRA CM.36X51 (INCLUSA 1 TESTATA CHIUSURA PIANO MOD.TPA-7)

EN Gas Fry-top grooved chromed griddle SUPERCHROME (Moca Approved), plate cm.36x51 (included 1 Head end filler strip mod.TPA-7)

DE Gas-griddleplatte gerillt hartverchromt SUPERCHROME (Moca Approved), platte cm.36x51 (inbegriffen 1 Abschluss-Element mod.TPA-7)

FR Plaque gaz nervurée chromée SUPERCHROME (Moca Approved), plaque cm.36x51 (inclus 1 Élément de jonction top mod.TPA-7)

ES **FRY-TOP GAS ESTRIADO CROMADO SUPERCHROME (MOCA APPROVED), PLANCHA CM.36X51 (INCLUIDA 1 CHAPA DE CIERRE PARA TOP MOD.TPA-7)**

cm. 40 x 70,5 x 28h

cm. 43 x 77 x 54h / kg 63 / m³ 0,179

7 kW
6.020 kcal/h

€ 2.745,00

FTLT-76G

18230651



FRY-TOP GAS LISCIO, PIASTRA CM.56X51 (INCLUSA 1 TESTATA CHIUSURA PIANO MOD. TPA-7)

EN Gas Fry-top smooth griddle, plate cm.56x51 (included 1 Head end filler strip mod. TPA-7)

DE Gas-griddleplatte glatt, platte cm.56x51 (inbegriffen 1 Abschluss-Element mod. TPA-7)

FR Plaque gaz lisse, plaque cm.56x51 (inclus 1 Élément de jonction top mod.TPA-7)

ES **FRY-TOP GAS LISO, PLANCHA CM.56X51 (INCLUIDA 1 CHAPA DE CIERRE PARA TOP MOD.TPA-7)**

cm. 60 x 70,5 x 28h

cm. 63 x 77 x 54h / kg 68 / m³ 0,262

10,5 kW
9.030 kcal/h

€ 2.482,00

FTLT-76GS

18230654

FRY-TOP GAS LISCIO CROMATO SUPERCHROME (MOCA APPROVED), PIASTRA CM.56X51 (INCLUSA 1 TESTATA CHIUSURA PIANO MOD.TPA-7)

EN Gas Fry-top smooth chromed griddle SUPERCHROME (Moca Approved), plate cm.56x51 (included 1 Head end filler strip mod.TPA-7)

DE Gas-griddleplatte glatt hartverchromt SUPERCHROME (Moca Approved), platte cm.56x51 (inbegriffen 1 Abschluss-Element mod.TPA-7)

FR Plaque gaz lisse chromée SUPERCHROME (Moca Approved), plaque cm.56x51 (inclus 1 Élément de jonction top mod.TPA-7)

ES **FRY-TOP GAS LISO CROMADO SUPERCHROME (MOCA APPROVED), PLANCHA CM.56X51 (INCLUIDA 1 CHAPA DE CIERRE PARA TOP MOD.TPA-7)**

cm. 60 x 70,5 x 28h

cm. 63 x 77 x 54h / kg 68 / m³ 0,262

10,5 kW
9.030 kcal/h

€ 3.092,00

FTLT-76GSS

18230650

FRY-TOP GAS LISCIO CROMO LUCIDO, PIASTRA CM.56X51 (INCLUSA 1 TESTATA CHIUSURA PIANO MOD.TPA-7)

EN Gas Fry-top smooth POLISHED CHROME, plate cm.56x51 (included 1 Head end filler strip mod.TPA-7)

DE Gas-griddleplatte glatt POLIERTEM CHROM, platte cm.56x51 (inbegriffen 1 Abschluss-Element mod.TPA-7)

FR Plaque gaz lisse CHROME POLI, plaque cm.56x51 (inclus 1 Élément de jonction top mod.TPA-7)

ES **FRY-TOP GAS LISO CROMO PULIDO, PLANCHA CM.56X51 (INCLUIDA 1 CHAPA DE CIERRE PARA TOP MOD.TPA-7)**

cm. 60 x 70,5 x 28h

cm. 63 x 77 x 54h / kg 68 / m³ 0,262

10,5 kW
9.030 kcal/h

€ 3.092,00

FTLRT-76G

18230652



FRY-TOP GAS 1/2 RIGATO + 1/2 LISCIO, PIASTRA CM.56X51 (INCLUSA 1 TESTATA CHIUSURA PIANO MOD.TPA-7)

EN Gas Fry-top 1/2 grooved + 1/2 smooth, plate cm.56x51 (included 1 Head end filler strip mod.TPA-7)

DE Gas-griddleplatte 1/2 gerillt + 1/2 glatt, platte cm.56x51 (inbegriffen 1 Abschluss-Element mod.TPA-7)

FR Plaque gaz 1/2 nervurée + 1/2 lisse, plaque cm.56x51 (inclus 1 Élément de jonction top mod.TPA-7)

ES **FRY-TOP GAS 1/2 ESTRIADO + 1/2 LISO, PLANCHA CM.56X51 (INCLUIDA 1 CHAPA DE CIERRE PARA TOP MOD.TPA-7)**

cm. 60 x 70,5 x 28h

cm. 63 x 77 x 54h / kg 68 / m³ 0,262

10,5 kW
9.030 kcal/h

€ 2.658,00

FTLRT-76GS

18230655

FRY-TOP GAS 1/2 RIGATO + 1/2 LISCIO CROMATO SUPERCHROME (MOCA APPROVED), PIASTRA CM.56X51 (INCLUSA 1 TESTATA CHIUSURA PIANO MOD.TPA-7)

EN Gas Fry-top 1/2 grooved + 1/2 smooth chromed griddle SUPERCHROME (Moca Approved), plate cm.56x51 (included 1 Head end filler strip mod.TPA-7)

DE Gas-griddleplatte 1/2 gerillt + 1/2 glatt hartverchromt SUPERCHROME (Moca Approved), platte cm.56x51 (inbegriffen 1 Abschluss-Element mod.TPA-7)

FR Plaque gaz 1/2 nervurée + 1/2 lisse chromée SUPERCHROME (Moca Approved), plaque cm.56x51 (inclus 1 Élément de jonction top mod.TPA-7)

ES **FRY-TOP GAS 1/2 ESTRIADO + 1/2 LISO CROMADO SUPERCHROME (MOCA APPROVED), PLANCHA CM.56X51 (INCLUIDA 1 CHAPA DE CIERRE PARA TOP MOD.TPA-7)**

cm. 60 x 70,5 x 28h

cm. 63 x 77 x 54h / kg 68 / m³ 0,262

10,5 kW
9.030 kcal/h

€ 3.271,00

FTRT-76G

18230653



FRY-TOP GAS RIGATO, PIASTRA CM.56X51 (INCLUSA 1 TESTATA CHIUSURA PIANO MOD. TPA-7)

EN Gas Fry-top grooved griddle, plate cm.56x51 (included 1 Head end filler strip mod. TPA-7)

DE Gas-griddleplatte gerillt, platte cm.56x51 (inbegriffen 1 Abschluss-Element mod. TPA-7)

FR Plaque gaz nervurée, plaque cm.56x51 (inclus 1 Élément de jonction top mod.TPA-7)

ES **FRY-TOP GAS ESTRIADO, PLANCHA CM.56X51 (INCLUIDA 1 CHAPA DE CIERRE PARA TOP MOD.TPA-7)**

cm. 60 x 70,5 x 28h

cm. 63 x 77 x 54h / kg 68 / m³ 0,262

10,5 kW
9.030 kcal/h

€ 2.836,00**FTRT-76GS**

18230656

FRY-TOP GAS RIGATO CROMATO SUPERCHROME (MOCA APPROVED), PIASTRA CM.56X51 (INCLUSA 1 TESTATA CHIUSURA PIANO MOD.TPA-7)

EN Gas Fry-top grooved chromed griddle SUPERCHROME (Moca Approved), plate cm.56x51 (included 1 Head end filler strip mod.TPA-7)

DE Gas-griddleplatte gerillt hartverchromt SUPERCHROME (Moca Approved), platte cm.56x51 (inbegriffen 1 Abschluss-Element mod.TPA-7)

FR Plaque gaz nervurée chromée SUPERCHROME (Moca Approved), plaque cm.56x51 (inclus 1 Élément de jonction top mod.TPA-7)

ES **FRY-TOP GAS ESTRIADO CROMADO SUPERCHROME (MOCA APPROVED), PLANCHA CM.56X51 (INCLUIDA 1 CHAPA DE CIERRE PARA TOP MOD.TPA-7)**

cm. 60 x 70,5 x 28h

cm. 63 x 77 x 54h / kg 68 / m³ 0,262

10,5 kW
9.030 kcal/h

€ 3.450,00**FTLT-78G**

18230851



FRY-TOP GAS LISCIO, PIASTRA CM.76X51 - 2 ZONE DI COTTURA (INCLUSA 1 TESTATA CHIUSURA PIANO MOD.TPA-7)

EN Gas Fry-top smooth griddle, plate cm.76x51 - 2 cooking areas (included 1 Head end filler strip mod.TPA-7)

DE Gas-griddleplatte glatt, platte cm.76x51 - 2 Heizzonen (inbegriffen 1 Abschluss-Element mod.TPA-7)

FR Plaque gaz lisse, plaque cm.76x51 - 2 zones de cuisson (inclus 1 Élément de jonction top mod.TPA-7)

ES **FRY-TOP GAS LISO, PLANCHA CM.76X51 - 2 ZONAS DE COCCIÓN (INCLUIDA 1 CHAPA DE CIERRE PARA TOP MOD.TPA-7)**

cm. 80 x 70,5 x 28h

cm. 83 x 77 x 54h / kg 108 / m³ 0,345

14 kW
12.040 kcal/h

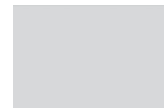
€ 3.658,00**FTLT-78GS**

18230854

FRY-TOP GAS LISCIO CROMATO SUPERCHROME (MOCA APPROVED), PIASTRA CM.76X51 - 2 ZONE DI COTTURA (INCLUSA 1 TESTATA CHIUSURA PIANO MOD.TPA-7)

EN Gas Fry-top smooth chromed griddle SUPERCHROME (Moca Approved), plate cm.76x51 - 2 cooking areas (included 1 Head end filler strip mod.TPA-7)

DE Gas-griddleplatte glatt hartverchromt SUPERCHROME (Moca Approved), platte cm.76x51 - 2 Heizzonen (inbegriffen 1 Abschluss-Element mod.TPA-7)

FR Plaque gaz lisse chromée SUPERCHROME (Moca Approved), plaque cm.76x51 - 2 zones de cuisson (inclus 1 Élément de jonction top mod.TPA-7)

ES **FRY-TOP GAS LISO CROMADO SUPERCHROME (MOCA APPROVED), PLANCHA CM.76X51 - 2 ZONAS DE COCCIÓN (INCLUIDA 1 CHAPA DE CIERRE PARA TOP MOD.TPA-7)**

cm. 80 x 70,5 x 28h

cm. 83 x 77 x 54h / kg 108 / m³ 0,345

14 kW
12.040 kcal/h

€ 4.557,00**FTLT-78GSS**

18230850

FRY-TOP GAS LISCIO CROMO LUCIDO, PIASTRA CM.76X51 - 2 ZONE DI COTTURA (INCLUSA 1 TESTATA CHIUSURA PIANO MOD.TPA-7)

EN Gas Fry-top smooth POLISHED CHROME, plate cm.76x51 - 2 cooking areas (included 1 Head end filler strip mod.TPA-7)

DE Gas-griddleplatte glatt POLIERTEM CHROM, platte cm.76x51 - 2 Heizzonen (inbegriffen 1 Abschluss-Element mod.TPA-7)

FR Plaque gaz lisse CHROME POLI, plaque cm.76x51 - 2 zones de cuisson (inclus 1 Élément de jonction top mod.TPA-7)

ES **FRY-TOP GAS LISO CROMO PULIDO, PLANCHA CM.76X51 - 2 ZONAS DE COCCIÓN (INCLUIDA 1 CHAPA DE CIERRE PARA TOP MOD.TPA-7)**

cm. 80 x 70,5 x 28h

cm. 83 x 77 x 54h / kg 108 / m³ 0,345

14 kW
12.040 kcal/h

€ 4.557,00

FTLRT-78G

18230852



FRY-TOP GAS 1/2 RIGATO + 1/2 LISCIO, PIASTRA CM.76X51 - 2 ZONE DI COTTURA (INCLUSA 1 TESTATA CHIUSURA PIANO MOD.TPA-7)

- EN** Gas Fry-top 1/2 grooved + 1/2 smooth, plate cm.76x51 - 2 cooking areas (included 1 Head end filler strip mod.TPA-7)
- DE** Gas-griddleplatte 1/2 gerillt + 1/2 glatt, platte cm.76x51 - 2 Heizzonen (inbegriffen 1 Abschluss-Element mod.TPA-7)
- FR** Plaque gaz 1/2 nervurée + 1/2 lisse, plaque cm.76x51 - 2 zones de cuisson (inclus 1 Élément de jonction top mod.TPA-7)

ES FRY-TOP GAS 1/2 ESTRIADO + 1/2 LISO, PLANCHA CM.76X51 - 2 ZONAS DE COCCIÓN (INCLUIDA 1 CHAPA DE CIERRE PARA TOP MOD.TPA-7)

cm. 80 x 70,5 x 28h

cm. 83 x 77 x 54h / kg 108 / m³ 0,345

14 kW
12.040 kcal/h

€ 3.869,00

FTLRT-78GS

18230855

FRY-TOP GAS 1/2 RIGATO + 1/2 LISCIO CROMATO SUPERCHROME (MOCA APPROVED), PIASTRA CM.76X51 - 2 ZONE DI COTTURA (INCLUSA 1 TESTATA CHIUSURA PIANO MOD. TPA-7)

- EN** Gas Fry-top 1/2 grooved + 1/2 smooth chromed griddle SUPERCHROME (Moca Approved), plate cm.76x51 - 2 cooking areas (included 1 Head end filler strip mod. TPA-7)
- DE** Gas-griddleplatte 1/2 gerillt + 1/2 glatt hartverchromt SUPERCHROME (Moca Approved), platte cm.76x51 - 2 Heizzonen (inbegriffen 1 Abschluss-Element mod. TPA-7)
- FR** Plaque gaz 1/2 nervurée + 1/2 lisse chromée SUPERCHROME (Moca Approved), plaque cm.76x51 - 2 zones de cuisson (inclus 1 Élément de jonction top mod.TPA-7)

ES FRY-TOP GAS 1/2 ESTRIADO + 1/2 LISO CROMADO SUPERCHROME (MOCA APPROVED), PLANCHA CM.76X51 - 2 ZONAS DE COCCIÓN (INCLUIDA 1 CHAPA DE CIERRE PARA TOP MOD.TPA-7)

cm. 80 x 70,5 x 28h

cm. 83 x 77 x 54h / kg 108 / m³ 0,345

14 kW
12.040 kcal/h

€ 4.768,00

FTRT-78G

18230853



FRY-TOP GAS RIGATO, PIASTRA CM.76X51 - 2 ZONE DI COTTURA (INCLUSA 1 TESTATA CHIUSURA PIANO MOD.TPA-7)

- EN** Gas Fry-top grooved griddle, plate cm.76x51 - 2 cooking areas (included 1 Head end filler strip mod.TPA-7)
- DE** Gas-griddleplatte gerillt, platte cm.76x51 - 2 Heizzonen (inbegriffen 1 Abschluss-Element mod.TPA-7)
- FR** Plaque gaz nervurée, plaque cm.76x51 - 2 zones de cuisson (inclus 1 Élément de jonction top mod.TPA-7)

ES FRY-TOP GAS ESTRIADO, PLANCHA CM.76X51 - 2 ZONAS DE COCCIÓN (INCLUIDA 1 CHAPA DE CIERRE PARA TOP MOD.TPA-7)

cm. 80 x 70,5 x 28h

cm. 83 x 77 x 54h / kg 108 / m³ 0,345

14 kW
12.040 kcal/h

€ 4.083,00

FTRT-78GS

18230856

FRY-TOP GAS RIGATO CROMATO SUPERCHROME (MOCA APPROVED), PIASTRA CM.76X51 - 2 ZONE DI COTTURA (INCLUSA 1 TESTATA CHIUSURA PIANO MOD.TPA-7)

- EN** Gas Fry-top grooved chromed griddle SUPERCHROME (Moca Approved), plate cm.76x51 - 2 cooking areas (included 1 Head end filler strip mod.TPA-7)
- DE** Gas-griddleplatte gerillt hartverchromt SUPERCHROME (Moca Approved), platte cm.76x51 - 2 Heizzonen (inbegriffen 1 Abschluss-Element mod.TPA-7)
- FR** Plaque gaz nervurée chromée SUPERCHROME (Moca Approved), plaque cm.76x51 - 2 zones de cuisson (inclus 1 Élément de jonction top mod.TPA-7)

ES FRY-TOP GAS ESTRIADO CROMADO SUPERCHROME (MOCA APPROVED), PLANCHA CM.76X51 - 2 ZONAS DE COCCIÓN (INCLUIDA 1 CHAPA DE CIERRE PARA TOP MOD.TPA-7)

cm. 80 x 70,5 x 28h

cm. 83 x 77 x 54h / kg 108 / m³ 0,345

14 kW
12.040 kcal/h

€ 4.981,00

FTLT-712G

18231254



FRY-TOP GAS LISCIO, PIASTRA CM.116X51 - 2 ZONE DI COTTURA (INCLUSA 1 TESTATA CHIUSURA PIANO MOD.TPA-7)

EN Gas Fry-top smooth griddle, plate cm.116x51 - 2 cooking areas (included 1 Head end filler strip mod.TPA-7)

DE Gas-griddleplatte glatt, platte cm.116x51 - 2 Heizzonen (inbegriffen 1 Abschluss-Element mod.TPA-7)

FR Plaque gaz lisse, plaque cm.116x51 - 2 zones de cuisson (inclus 1 Élément de jonction top mod.TPA-7)

ES **FRY-TOP GAS LISO, PLANCHA CM.116X51 - 2 ZONAS DE COCCIÓN (INCLUIDA 1 CHAPA DE CIERRE PARA TOP MOD.TPA-7)**

cm. 120 x 70,5 x 28h

cm. 123 x 77 x 54h / kg 120 / m³ 0,511

21 kW
18.060 kcal/h

€ 4.837,00**FTLT-712GS**

18231254

FRY-TOP GAS LISCIO CROMATO SUPERCHROME (MOCA APPROVED), PIASTRA CM.116X51 - 2 ZONE DI COTTURA (INCLUSA 1 TESTATA CHIUSURA PIANO MOD.TPA-7)

EN Gas Fry-top smooth chromed griddle SUPERCHROME (Moca Approved), plate cm.116x51 - 2 cooking areas (included 1 Head end filler strip mod.TPA-7)

DE Gas-griddleplatte glatt hartverchromt SUPERCHROME (Moca Approved), platte cm.116x51 - 2 Heizzonen (inbegriffen 1 Abschluss-Element mod.TPA-7)

FR Plaque gaz lisse chromée SUPERCHROME (Moca Approved), plaque cm.116x51 - 2 zones de cuisson (inclus 1 Élément de jonction top mod.TPA-7)

ES **FRY-TOP GAS LISO CROMADO SUPERCHROME (MOCA APPROVED), PLANCHA CM.116X51 - 2 ZONAS DE COCCIÓN (INCLUIDA 1 CHAPA DE CIERRE PARA TOP MOD.TPA-7)**

cm. 120 x 70,5 x 28h

cm. 123 x 77 x 54h / kg 120 / m³ 0,511

21 kW
18.060 kcal/h

€ 5.773,00**FTLRT-712G**

18231252



FRY-TOP GAS 1/2 RIGATO + 1/2 LISCIO, PIASTRA CM.116X51 - 2 ZONE DI COTTURA (INCLUSA 1 TESTATA CHIUSURA PIANO MOD.TPA-7)

EN Gas Fry-top 1/2 grooved + 1/2 smooth, plate cm.116x51 - 2 cooking areas (included 1 Head end filler strip mod.TPA-7)

DE Gas-griddleplatte 1/2 gerillt + 1/2 glatt, platte cm.116x51 - 2 Heizzonen (inbegriffen 1 Abschluss-Element mod.TPA-7)

FR Plaque gaz 1/2 nervurée + 1/2 lisse, plaque cm.116x51 - 2 zones de cuisson (inclus 1 Élément de jonction top mod.TPA-7)

ES **FRY-TOP GAS 1/2 ESTRIADO + 1/2 LISO, PLANCHA CM.116X51 - 2 ZONAS DE COCCIÓN (INCLUIDA 1 CHAPA DE CIERRE PARA TOP MOD.TPA-7)**

cm. 120 x 70,5 x 28h

cm. 123 x 77 x 54h / kg 120 / m³ 0,511

21 kW
18.060 kcal/h

€ 5.098,00**FTLRT-712GS**

18231255

FRY-TOP GAS 1/2 RIGATO + 1/2 LISCIO CROMATO SUPERCHROME (MOCA APPROVED), PIASTRA CM.116X51 - 2 ZONE DI COTTURA (INCLUSA 1 TESTATA CHIUSURA PIANO MOD.TPA-7)

EN Gas Fry-top 1/2 grooved + 1/2 smooth chromed griddle SUPERCHROME (Moca Approved), plate cm.116x51 - 2 cooking areas (included 1 Head end filler strip mod.TPA-7)

DE Gas-griddleplatte 1/2 gerillt + 1/2 glatt hartverchromt SUPERCHROME (Moca Approved), platte cm.116x51 - 2 Heizzonen (inbegriffen 1 Abschluss-Element mod.TPA-7)

FR Plaque gaz 1/2 nervurée + 1/2 lisse chromée SUPERCHROME (Moca Approved), plaque cm.116x51 - 2 zones de cuisson (inclus 1 Élément de jonction top mod.TPA-7)

ES **FRY-TOP GAS 1/2 ESTRIADO + 1/2 LISO CROMADO SUPERCHROME (MOCA APPROVED), PLANCHA CM.116X51 - 2 ZONAS DE COCCIÓN (INCLUIDA 1 CHAPA DE CIERRE PARA TOP MOD.TPA-7)**

cm. 120 x 70,5 x 28h

cm. 123 x 77 x 54h / kg 120 / m³ 0,511

21 kW
18.060 kcal/h

€ 5.982,00

FTRT-712G

18231253



FRY-TOP GAS RIGATO, PIASTRA CM.116X51 - 2 ZONE DI COTTURA (INCLUSA 1 TESTATA CHIUSURA PIANO MOD.TPA-7)

- EN** Gas Fry-top grooved griddle, plate cm.116x51 - 2 cooking areas (included 1 Head end filler strip mod.TPA-7)
- DE** Gas-griddleplatte gerillt, platte cm.116x51 - 2 Heizzonen (inbegriffen 1 Abschluss-Element mod.TPA-7)
- FR** Plaque gaz nervurée, plaque cm.116x51 - 2 zones de cuisson (inclus 1 Élément de jonction top mod.TPA-7)

ES FRY-TOP GAS ESTRIADO, PLANCHA CM.116X51 - 2 ZONAS DE COCCIÓN (INCLUIDA 1 CHAPA DE CIERRE PARA TOP MOD.TPA-7)

cm. 120 x 70,5 x 28h

cm. 123 x 77 x 54h / kg 120 / m³ 0,511

21 kW **€ 5.359,00**
18.060 kcal/h

FTRT-712GS

18231256

FRY-TOP GAS RIGATO CROMATO SUPERCHROME (MOCA APPROVED), PIASTRA CM.116X51 - 2 ZONE DI COTTURA (INCLUSA 1 TESTATA CHIUSURA PIANO MOD.TPA-7)

- EN** Gas Fry-top grooved chromed griddle SUPERCHROME (Moca Approved), plate cm.116x51 - 2 cooking areas (included 1 Head end filler strip mod.TPA-7)
- DE** Gas-griddleplatte gerillt hartverchromt SUPERCHROME (Moca Approved), platte cm.116x51 - 2 Heizzonen (inbegriffen 1 Abschluss-Element mod.TPA-7)
- FR** Plaque gaz nervurée chromée SUPERCHROME (Moca Approved), plaque cm.116x51 - 2 zones de cuisson (inclus 1 Élément de jonction top mod.TPA-7)

ES FRY-TOP GAS ESTRIADO CROMADO SUPERCHROME (MOCA APPROVED), PLANCHA CM.116X51 - 2 ZONAS DE COCCIÓN (INCLUIDA 1 CHAPA DE CIERRE PARA TOP MOD.TPA-7)

cm. 120 x 70,5 x 28h

cm. 123 x 77 x 54h / kg 120 / m³ 0,511

21 kW **€ 6.258,00**
18.060 kcal/h

FTLT-712G3

1823125B



FRY-TOP GAS LISCIO, PIASTRA CM.116X51 - 3 ZONE DI COTTURA (INCLUSA 1 TESTATA CHIUSURA PIANO MOD.TPA-7)

- EN** Gas Fry-top smooth griddle, plate cm.116x51 - 3 cooking areas (included 1 Head end filler strip mod.TPA-7)
- DE** Gas-griddleplatte glatt, platte cm.116x51 - 3 Heizzonen (inbegriffen 1 Abschluss-Element mod.TPA-7)
- FR** Plaque gaz lisse, plaque cm.116x51 - 3 zones de cuisson (inclus 1 Élément de jonction top mod.TPA-7)

ES FRY-TOP GAS LISO, PLANCHA CM.116X51 - 3 ZONAS DE COCCIÓN (INCLUIDA 1 CHAPA DE CIERRE PARA TOP MOD.TPA-7)

cm. 120 x 70,5 x 28h

cm. 123 x 77 x 54h / kg 120 / m³ 0,511

21 kW **€ 5.256,00**
18.060 kcal/h

FTLT-712GS3

1823125E

FRY-TOP GAS LISCIO CROMATO SUPERCHROME (MOCA APPROVED), PIASTRA CM.116X51 - 3 ZONE DI COTTURA (INCLUSA 1 TESTATA CHIUSURA PIANO MOD.TPA-7)

- EN** Gas Fry-top smooth chromed griddle SUPERCHROME (Moca Approved), plate cm.116x51 - 3 cooking areas (included 1 Head end filler strip mod.TPA-7)
- DE** Gas-griddleplatte glatt hartverchromt SUPERCHROME (Moca Approved), platte cm.116x51 - 3 Heizzonen (inbegriffen 1 Abschluss-Element mod.TPA-7)
- FR** Plaque gaz lisse chromée SUPERCHROME (Moca Approved), plaque cm.116x51 - 3 zones de cuisson (inclus 1 Élément de jonction top mod.TPA-7)

ES FRY-TOP GAS LISO CROMADO SUPERCHROME (MOCA APPROVED), PLANCHA CM.116X51 - 3 ZONAS DE COCCIÓN (INCLUIDA 1 CHAPA DE CIERRE PARA TOP MOD.TPA-7)

cm. 120 x 70,5 x 28h

cm. 123 x 77 x 54h / kg 120 / m³ 0,511

21 kW **€ 6.141,00**
18.060 kcal/h

FTLT-712GSS3

1823125Y

FRY-TOP GAS LISCIO CROMO LUCIDO, PIASTRA CM.116X51 - 3 ZONE DI COTTURA (INCLUSA 1 TESTATA CHIUSURA PIANO MOD.TPA-7)

- EN** Gas Fry-top smooth POLISHED CHROME, plate cm.116x51 - 3 cooking areas (included 1 Head end filler strip mod.TPA-7)
- DE** Gas-griddleplatte glatt POLIERTEM CHROM, platte cm.116x51 - 3 Heizzonen (inbegriffen 1 Abschluss-Element mod.TPA-7)
- FR** Plaque gaz lisse CHROME POLI, plaque cm.116x51 - 3 zones de cuisson (inclus 1 Élément de jonction top mod.TPA-7)

ES FRY-TOP GAS LISO CROMO PULIDO, PLANCHA CM.116X51 - 3 ZONAS DE COCCIÓN (INCLUIDA 1 CHAPA DE CIERRE PARA TOP MOD.TPA-7)

cm. 120 x 70,5 x 28h

cm. 123 x 77 x 54h / kg 120 / m³ 0,511

21 kW **€ 6.141,00**
18.060 kcal/h



FTLRT-712G3

1823125C



FRY-TOP GAS 1/3 RIGATO + 2/3 LISCIO, PIASTRA CM.116X51 - 3 ZONE DI COTTURA (INCLUSA 1 TESTATA CHIUSURA PIANO MOD.TPA-7)

- EN** Gas Fry-top 1/3 grooved + 2/3 smooth, plate cm.116x51 - 3 cooking areas (included 1 Head end filler strip mod.TPA-7)
- DE** Gas-griddleplatte 1/3 gerillt + 2/3 glatt, platte cm.116x51 - 3 Heizzonen (inbegriffen 1 Abschluss-Element mod.TPA-7)
- FR** Plaque gaz 1/3 nervurée + 2/3 lisse, plaque cm.116x51 - 3 zones de cuisson (inclus 1 Élément de jonction top mod.TPA-7)
- ES** **FRY-TOP GAS 1/3 ESTRIADO + 2/3 LISO, PLANCHA CM.116X51 - 3 ZONAS DE COCCIÓN (INCLUIDA 1 CHAPA DE CIERRE PARA TOP MOD.TPA-7)**

cm. 120 x 70,5 x 28h

cm. 123 x 77 x 54h / kg 120 / m³ 0,511

21 kW **€ 5.390,00**
18.060 kcal/h

**FTLRT-712GS3**

1823125F

FRY-TOP GAS 1/3 RIGATO + 2/3 LISCIO CROMATO SUPERCHROME (MOCA APPROVED), PIASTRA CM.116X51 - 3 ZONE DI COTTURA (INCLUSA 1 TESTATA CHIUSURA PIANO MOD. TPA-7)

- EN** Gas Fry-top 1/3 grooved + 2/3 smooth chromed griddle SUPERCHROME (Moca Approved), plate cm.116x51 - 3 cooking areas (included 1 Head end filler strip mod. TPA-7)
- DE** Gas-griddleplatte 1/3 gerillt + 2/3 glatt hartverchromt SUPERCHROME (Moca Approved), platte cm.116x51 - 3 Heizzonen (inbegriffen 1 Abschluss-Element mod. TPA-7)
- FR** Plaque gaz 1/3 nervurée + 2/3 lisse chromée SUPERCHROME (Moca Approved), plaque cm.116x51 - 3 zones de cuisson (inclus 1 Élément de jonction top mod.TPA-7)
- ES** **FRY-TOP GAS 1/3 ESTRIADO + 2/3 LISO CROMADO SUPERCHROME (MOCA APPROVED), PLANCHA CM.116X51 - 3 ZONAS DE COCCIÓN (INCLUIDA 1 CHAPA DE CIERRE PARA TOP MOD.TPA-7)**

cm. 120 x 70,5 x 28h

cm. 123 x 77 x 54h / kg 120 / m³ 0,511

21 kW **€ 6.351,00**
18.060 kcal/h

**GRIGLIE ELETTRICHE - TOP**

EN ELECTRIC GRILL - TOP **DE** ELEKTRO-WURSTBRATER - TOP **FR** CHARCOAL ÉLECTRIQUE - TOP **ES** BARBACOAS ELECTRICAS - TOP

CWKT-74ET

18080431



GRIGLIA CONTACT - COTTURA DIRETTA SU RESISTENZA IN ACCIAIO INOX CM. 27X43 RIBALTABILE (INCLUSA 1 TESTATA CHIUSURA PIANO MOD.TPA-7)

- EN** CONTACT Grill threephase - rotatable stainless steel grill cm. 27x43 (included 1 Head end filler strip mod.TPA-7)
- DE** Wurstbrater dreiphasig KONTAKT - Drehbaren Heizelement aus Edelstahl cm. 27x43 (inbegriffen 1 Abschluss-Element mod.TPA-7)
- FR** Grillade triphase CONTACT - Grille inox rotatif cm 27x43 (inclus 1 Élément de jonction top mod.TPA-7)
- ES** **PARRILLA TRIFÁSICO CONTACT - PARRILLA GIRATORIA DE ACERO INOX CM 27X43 (INCLUIDA 1 CHAPA DE CIERRE PARA TOP MOD.TPA-7)**

cm. 40 x 70,5 x 28h

cm. 43 x 77 x 54h / kg 55 / m³ 0,179

4,08 KW **€ 3.191,00**
400V~3N
50/60 Hz

CWKT-78ET

18080831



GRIGLIA CONTACT - COTTURA DIRETTA SU RESISTENZA IN ACCIAIO INOX CM. 55X43 RIBALTABILE - 2 ZONE COTTURA (INCLUSA 1 TESTATA CHIUSURA PIANO MOD.TPA-7)

- EN** CONTACT Grill threephase - rotatable stainless steel grill cm. 55x43 - 2 cooking areas (included 1 Head end filler strip mod.TPA-7)
- DE** Wurstbrater dreiphasig KONTAKT - Drehbaren Heizelement aus Edelstahl cm. 55x43 - 2 Heizzonen (inbegriffen 1 Abschluss-Element mod.TPA-7)
- FR** Grillade triphase CONTACT - Grille inox rotatif cm 55x43 - 2 zones de cuisson (inclus 1 Élément de jonction top mod.TPA-7)
- ES** **PARRILLA TRIFÁSICO CONTACT - PARRILLA GIRATORIA DE ACERO INOX CM 55X43 - 2 ZONAS DE COCCIÓN (INCLUIDA 1 CHAPA DE CIERRE PARA TOP MOD.TPA-7)**

cm. 80 x 70,5 x 28h

cm. 83 x 77 x 54h / kg 85 / m³ 0,345

8,16 KW **€ 4.308,00**
400V~3N
50/60 Hz

CWT-74ET

18080430



GRIGLIA TRIFASE GRIGLIA IN ACCIAIO INOX CM. 38X52 REGOLABILE (INCLUSA 1 TESTATA CHIUSURA PIANO MOD.TPA-7)

EN Grill threephase - Stainless steel grill cm. 38x52 (included 1 Head end filler strip mod.TPA-7)

DE Wurstbrater dreiphasig - Einstellbarer Rost aus Nirosta cm. 38x52 (inbegriffen 1 Abschluss-Element mod.TPA-7)

FR Grillade triphase - Grille inox cm 38x52 (inclus 1 Élément de jonction top mod.TPA-7)

ES **PARRILLA TRIFÁSICO - PARRILLA DE ACERO INOX REGULABLE CM 38X52 (INCLUIDA 1 CHAPA DE CIERRE PARA TOP MOD.TPA-7)**

cm. 40 x 70,5 x 28h

 cm. 43 x 77 x 63h / kg 57 / m³ 0,209

6 kW
400V~3N
230V~3
50/60 Hz

€ 2.303,00
CWT-78ET

18080830



GRIGLIA TRIFASE N. 2 GRIGLIE IN ACCIAIO INOX CM. 38X52 REGOLABILI 2 ZONE DI COTTURA (INCLUSA 1 TESTATA CHIUSURA PIANO MOD.TPA-7)

EN Grill threephase - N. 2 Stainless steel grill cm. 38x52. 2 cooking areas (included 1 Head end filler strip mod.TPA-7)

DE Wurstbrater dreiphasig - N. 2 einstellbare Roste aus Nirosta cm. 38x52 - 2 Heizzonen (inbegriffen 1 Abschluss-Element mod.TPA-7)

FR Grillade triphase - N. 2 grilles réglables en acier inox cm. 38x52 - 2 zones de cuisson (inclus 1 Élément de jonction top mod.TPA-7)

ES **PARRILLA TRIFÁSICO - N. 2 PARRILLAS DE ACERO INOX REGULABLE CM 38X52 - 2 ZONAS DE COCCIÓN (INCLUIDA 1 CHAPA DE CIERRE PARA TOP MOD.TPA-7)**

cm. 80 x 70,5 x 28h

 cm. 83 x 77 x 63h / kg 87 / m³ 0,403

12 kW
400V~3N
230V~3
50/60 Hz

€ 3.475,00
GRIGLIE PIETRA LAVICA A GAS - TOP
EN GAS CHARCOAL GRILL - TOP **DE** GASLAVASTEIN GRILLS - TOP **FR** CHARCOAL EN PIERRE DE LAVE À GAZ - TOP **ES** **BARBACOAS DE PIEDRA LÁVICA A GAS - TOP**
CWT-74G

18250450



GRIGLIA GAS-PIETRALAVICA GRIGLIA IN ACCIAIO INOX CM. 38X52 REGOLABILE (INCLUSA 1 TESTATA CHIUSURA PIANO MOD.TPA-7)

EN Lavastone grill gas - Stainless steel grill cm. 38x52 (included 1 Head end filler strip mod.TPA-7)

DE Gas-Lavasteingrill - Einstellbarer Rost aus Nirosta cm. 38x52 (inbegriffen 1 Abschluss-Element mod.TPA-7)

FR Grille à gaz en pierre de lave - Grille inox cm 38x52 (inclus 1 Élément de jonction top mod.TPA-7)

ES **PARRILLA A GAS PIEDRA LÁVICA - PARRILLA DE ACERO INOX REGULABLE CM 38X52 (INCLUIDA 1 CHAPA DE CIERRE PARA TOP MOD.TPA-7)**

cm. 40 x 70,5 x 28h

 cm. 43 x 77 x 63h / kg 56 / m³ 0,209

9 kW
7.740 kcal/h

€ 2.434,00
CWT-78G

18250850



GRIGLIA GAS-PIETRALAVICA N. 2 GRIGLIE IN ACCIAIO INOX CM. 38X52 REGOLABILI 2 ZONE DI COTTURA (INCLUSA 1 TESTATA CHIUSURA PIANO MOD.TPA-7)

EN Lavastone grill gas - N. 2 Stainless steel grill cm. 38x52 2 cooking areas (included 1 Head end filler strip mod.TPA-7)

DE Gas-Lavasteingrill - N. 2 einstellbare Roste aus Nirosta cm. 38x52 - 2 Heizzonen (inbegriffen 1 Abschluss-Element mod.TPA-7)

FR Grille a gaz en pierre de lave - N. 2 grilles réglables en acier inox cm. 38x52 - 2 zones de cuisson (inclus 1 Élément de jonction top mod.TPA-7)

ES **PARRILLA A GAS PIEDRA LÁVICA - N. 2 PARRILLAS DE ACERO INOX REGULABLE CM 38X52 - 2 ZONAS DE COCCIÓN (INCLUIDA 1 CHAPA DE CIERRE PARA TOP MOD.TPA-7)**

cm. 80 x 70,5 x 28h

 cm. 83 x 77 x 63h / kg 97 / m³ 0,403

18 kW
15.480 kcal/h

€ 3.798,00

FRIGGITRICI ELETTRICHE - TOP

EN ELECRTIC FRYERS - TOP DE ELEKTRO-FRITEUSE - TOP FR FRITEUSE ÉLECTRIQUE - TOP ES FREIDORAS ELECTRICAS - TOP

F2/8T-74ET
18090432

FRIGGITRICE TRIFASE LT. 8+8 2 VASCHE CM. 14,8X35,5X22,5H - 2 CESTI CM. 12X29X11,5H - FILTRO E COPERCHIO VASCA. PRODUZIONE PATATE: 12 KG/H (INCLUSA 1 TESTATA CHIUSURA PIANO MOD.TPA-7)

- EN** Fryer threephase 8+8 lts - 2 Bowls cm. 14,8x35,5x22,5h - 2 baskets cm. 12x29x11,5h. Sieve and lid for pan. Production: 12 kg/h (included 1 Head end filler strip mod.TPA-7)
- DE** Friteuse dreiphasig lt. 8+8 - 2 Becken cm. 14,8x35,5x22,5h - 2 Korb cm. 12x29x11,5h. Einlegesieb und Deckel für Becken. Pommes frites: 12 kg/h (inbegriffen 1 Abschluss-Element mod.TPA-7)
- FR** Friteuse triphase lt. 8+8 - 2 Cuve cm. 14,8x35,5x22,5h - 2 Panier cm. 12x29x11,5h. Filtre, couvercle pour cuve. Production de pommes frites: 12 kg/h (inclus 1 Elément de jonction top mod.TPA-7)
- ES** FREIDORAS TRIFÁSICO 8+8 LT. - 2CUBA CM. 14,8X35,5X22,5H- 2 CESTA CM. 12X29X11,5H. FILTRO Y TAPA PARA CUBA. PROD. PATATAS: 12 KG/H (INCLUIDA 1 CHAPA DE CIERRE PARA TOP MOD.TPA-7)

12 kW
400V~3N
230V~3
50/60 Hz

€ 3.426,00

cm. 40 x 70,5 x 28h
cm. 43 x 77 x 54h / kg 50 / m³ 0,179

F13T-74ET
18090430

FRIGGITRICE TRIFASE LT. 13 VASCA CM. 30,5X34X22,5H - 1 CESTO CM. 28X29X10H FILTRO E COPERCHIO VASCA - PRODUZIONE PATATE: 10 KG/H (INCLUSA 1 TESTATA CHIUSURA PIANO MOD.TPA-7)

- EN** Fryer threephase 13 lts - Bowl cm. 30,5x34x22,5h 1 basket cm. 28x29x10h - Sieve and lid for pan Production: 10 kg/h (included 1 Head end filler strip mod.TPA-7)
- DE** Friteuse dreiphasig lt. 13 - Becken cm. 30,5x34x22,5h - 1 Korb cm. 28x29x10h - Einlegesieb und Deckel für Becken - Pommes frites: 10 kg/h (inbegriffen 1 Abschluss-Element mod.TPA-7)
- FR** Friteuse triphase lt. 13 - Cuve cm. 30,5x34x22,5h - 1 Panier cm. 28x29x10h - Filtre, couvercle pour cuve Production de pommes frites: 10 kg/h (inclus 1 Elément de jonction top mod.TPA-7)
- ES** FREIDORAS TRIFÁSICO 13 LT. - CUBA CM. 30,5X34X22,5H - 1 CESTA CM. 28X29X10H - FILTRO Y TAPA PARA CUBA. PROD. PATATAS: 10 KG/H (INCLUIDA 1 CHAPA DE CIERRE PARA TOP MOD.TPA-7)

10,95 kW
400V~3N
50/60 Hz

€ 2.425,00

cm. 40 x 70,5 x 28h
cm. 43 x 77 x 54h / kg 48 / m³ 0,179

F2/13T-78ET
18090830

FRIGGITRICE TRIFASE LT. 13+13 2 VASCHE CM. 30,5X34X22,5H - 2 CESTI CM. 28X29X10H 2 FILTRI E COPERCHI VASCHE - PRODUZIONE PATATE: 20 KG/H (INCLUSA 1 TESTATA CHIUSURA PIANO MOD.TPA-7)

- EN** Fryer threephase 13+13 lts - 2 pans cm. 30,5x34x22,5h 2 baskets cm. 28x29x10h - 2 sieves and lids for pan Production: 20 kg/h (included 1 Head end filler strip mod. TPA-7)
- DE** Friteuse dreiphasig lt. 13+13 - 2 Becken cm. 30,5x34x22,5h 2 Körbe cm. 28x29x10h - Einlegesieb und Deckel für Becken - Pommes frites: 20 kg/h (inbegriffen 1 Abschluss-Element mod.TPA-7)
- FR** Friteuse triphase lt. 13+13 - 2 cuves cm. 30,5x34x22,5h 2 paniers cm. 28x29x10h - 2 filtres, couvercles pour cuve Production de pommes frites: 20 kg/h (inclus 1 Elément de jonction top mod.TPA-7)
- ES** FREIDORAS TRIFÁSICO 13+13 LT. - 2 CUBAS CM. 30,5X34X22,5H - 2 CESTAS CM. 28X29X10H . 2 FILTROS Y TAPAS PARA CUBAS PROD. PATATAS: 20 KG/H (INCLUIDA 1 CHAPA DE CIERRE PARA TOP MOD.TPA-7)

21,9 kW
400V~3N
50/60 Hz

€ 3.842,00

cm. 80 x 70,5 x 28h
cm. 83 x 77 x 54h / kg 75 / m³ 0,345

FRIGGITRICI A GAS - TOP
EN GAS FRYERS - TOP DE GAS-FRITEUSE - TOP FR FRITEUSE À GAZ - TOP ES FREIDORAS A GAS - TOP
F2/8T-74G
 18260452

FRIGGITRICE GAS LT. 8+8 - 2 VASCHE CM. 15X35X23H 2 CESTI CM. 12X30X9,5H. FILTRO E COPERCHIO VASCA. PROD. PATATE: 12 KG/H (INCLUSA 1 TESTATA CHIUSURA PIANO MOD.TPA-7)

- EN** Gas Fryer 8+8 lts - 2 pans cm. 15x35x23h 2 baskets cm. 12x30x9,5h. Sieve and lid for pan. Production: 12 kg/h (included 1 Head end filler strip mod.TPA-7)
- DE** Gas-Friteuse lt. 8+8 - 2 Becken cm. 15x35x23h 2 Körbe cm. 12x30x9,5h. Einlegesieb und Deckel für Becken. Pommes frites: 12 kg/h (inbegriffen 1 Abschluss-Element mod.TPA-7)
- FR** Friteuse à gaz lt. 8+8 - 2 cuves cm. 15x35x23h 2 paniers cm. 12x30x9,5h. Filtre, couvercle pour cuve. Production de pommes frites: 12 kg/h (inclus 1 Élément de jonction top mod.TPA-7)
- ES** FREIDORAS A GAS 8+8 LT. - 2 CUBAS CM. 15X35X23H 2 CESTAS CM. 12X30X9,5H. FILTRO Y TAPA PARA CUBA. PROD. PATATAS: 12 KG/H (INCLUIDA 1 CHAPA DE CIERRE PARA TOP MOD.TPA-7)

9 kW
7.740 kcal/h

€ 3.975,00

- cm. 40 x 70,5 x 28h
- cm. 43 x 77 x 54h / kg 50 / m³ 0,179

F13T-74G
 18260450

FRIGGITRICE GAS LT. 13 - VASCA CM. 31,5X34,5X22,5H 1 CESTO CM. 28X29X10H - FILTRO E COPERCHIO VASCA. PROD. PATATE: 10 KG/H (INCLUSA 1 TESTATA CHIUSURA PIANO MOD.TPA-7)

- EN** Gas Fryer 13 lts - Bowl cm. 31,5x34,5x22,5h - 1 basket cm. 28x29x10h - Sieve and lid for pan Production: 10 kg/h (included 1 Head end filler strip mod.TPA-7)
- DE** Gas-Friteuse lt. 13 - Becken cm. 31,5x34,5x22,5h - 1 Korb cm. 28x29x10h - Einlegesieb und Deckel für Becken - Pommes frites: 10 kg/h (inbegriffen 1 Abschluss-Element mod.TPA-7)
- FR** Friteuse à gaz lt. 13 - Cuve cm. 31,5x34,5x22,5h - 1 Panier cm. 28x29x10h - Filtre, couvercle pour cuve Production de pommes frites: 10 kg/h (inclus 1 Élément de jonction top mod.TPA-7)
- ES** FREIDORAS A GAS 13 LT. - CUBA CM. 31,5X34,5X22,5H - 1 CESTA CM. 28X29X10H - FILTRO Y TAPA PARA CUBA PROD. PATATAS: 10 KG/H (INCLUIDA 1 CHAPA DE CIERRE PARA TOP MOD.TPA-7)

12 kW
10.320 kcal/h

€ 2.664,00

- cm. 40 x 70,5 x 28h
- cm. 43 x 77 x 54h / kg 55 / m³ 0,179

F2/13T-78G
 18260850

FRIGGITRICE GAS LT. 13+13 2 VASCHE CM. 31,5X34,5X22,5H - 2 CESTI CM. 28X29X10H 2 FILTRI E COPERCHI VASCHE - PROD. PATATE: 20 KG/H (INCLUSA 1 TESTATA CHIUSURA PIANO MOD.TPA-7)

- EN** Gas Fryer 13+13 lts - 2 pans cm. 31,5x34,5x22,5h 2 baskets cm. 28x29x10h - 2 sieves and lids for pan Production: 20 kg/h (included 1 Head end filler strip mod.TPA-7)
- DE** Gas-Friteuse lt. 13+13 - 2 Becken cm. 31,5x34,5x22,5h 2 Körbe cm. 28x29x10h - Einlegesieb und Deckel für Becken - Pommes frites: 20 kg/h (inbegriffen 1 Abschluss-Element mod.TPA-7)
- FR** Friteuse à gaz lt. 13+13 - 2 cuves cm. 31,5x34,5x22,5h 2 paniers cm. 28x29x10h - 2 filtres, couvercles pour cuve Production de pommes frites: 20 kg/h (inclus 1 Élément de jonction top mod.TPA-7)
- ES** FREIDORAS A GAS 13+13 LT. - 2 CUBAS CM. 31,5X34,5X22,5H 2 CESTAS CM. 28X29X10H - 2 FILTROS Y TAPAS PARA CUBAS. PROD. PATATAS: 20 KG/H (INCLUIDA 1 CHAPA DE CIERRE PARA TOP MOD.TPA-7)

24 kW
20.640 kcal/h

€ 4.234,00

- cm. 80 x 70,5 x 28h
- cm. 83 x 77 x 54h / kg 81 / m³ 0,345

BASE CON FORNO ELETTRICO

EN STAND WITH ELECTRIC OVEN **DE** UNTERBAU MIT ELEKTRO ÖFEN **FR** PALCARD AVEC FOUR ÉLECTRIQUE **ES** MUEBLE CON HORNO ELECTRICO

MFV-78ET
08510830

BASE CON FORNO ELETTRICO MULTIFUNZIONE CM. 55X37X34H, TEMP: 50÷260°C, CON 1 GRIGLIA CM.53X32,5 GN1/1 - PORTA INOX (NON SOVRAPPORRE ELEMENTI AD INDUZIONE)

EN Stand with Multifunction electric oven cm. 55x37x34h, temp: 50÷260°C, with 1 grid cm.53x32,5 GN1/1 - Stainless steel door (no induction top)

DE unterbau mit Multifunktions-Elektroofen cm. 55x37x34h, temp: 50÷260°C, mit 1 Rost cm.53x32,5 GN1/1 - Edelstahltür (nicht Induktions)

FR placard avec Four électrique à fonctions multiples cm. 55x37x34h, temp: 50÷260°C, avec 1 grille cm.53x32,5 GN1/1 - Porte acier inoxydable (il faut pas de induction)

ES MUEBLE CON HORNO ELÉCTRICO MULTIFUNCIONAL CM. 55X37X34H, TEMP: 50÷250°C, CON 1 PARILLA CM.53X32,5 GN1/1 - PUERTA INOX (NO INDUCCIÓN)

cm. 80 x 63 x 57h

cm. 83 x 77 x 77h / kg 55 / m³ 0,492

€ 4.009,00
 5 kW
 400V~3N
 230V~3
 50/60 Hz

MFV-78ET/V
0851083A

BASE CON FORNO ELETTRICO MULTIFUNZIONE CM. 55X37X34H, TEMP: 50÷260°C, CON 1 GRIGLIA CM.53X32,5 GN1/1 - PORTA VETRO (NON SOVRAPPORRE ELEMENTI AD INDUZIONE)

EN Stand with Multifunction electric oven cm. 55x37x34h, temp: 50÷260°C, with 1 grid cm.53x32,5 GN1/1 - Glass door (no induction top)

DE unterbau mit Multifunktions-Elektroofen cm. 55x37x34h, temp: 50÷260°C, mit 1 Rost cm.53x32,5 GN1/1 - Glastür (nicht Induktions)

FR placard avec Four électrique à fonctions multiples cm. 55x37x34h, temp: 50÷260°C, avec 1 grille cm.53x32,5 GN1/1 - Porte vitrée (il faut pas de induction)

ES MUEBLE CON HORNO ELÉCTRICO MULTIFUNCIONAL CM. 55X37X34H, TEMP: 50÷250°C, CON 1 PARILLA CM.53X32,5 GN1/1 - PUERTA VIDRIO (NO INDUCCIÓN)

cm. 80 x 63 x 57h

cm. 83 x 77 x 77h / kg 55 / m³ 0,492

€ 4.160,00
 5 kW
 400V~3N
 230V~3
 50/60 Hz

MF-710ET
08491030

BASE CON FORNO ELETTRICO STATICO CM. 67X55X34H, TEMP: 50÷300°C, CON 1 GRIGLIA CM.65X53 GN2/1 (NON SOVRAPPORRE ELEMENTI AD INDUZIONE)

EN Stand with traditional electric oven cm. 67x55x34h, temp: 50÷300°C, with 1 grid cm.65x53 GN2/1 (no induction top)

DE unterbau mit Statischer Elektro-Backofen cm. 67x55x34h, temp: 50÷300°C, mit 1 Rost cm.65x53 GN2/1 (nicht Induktions)

FR placard avec Four électrique statique cm. 67x55x34h, temp: 50÷300°C, avec 1 grille cm.65x53 GN2/1 (il faut pas de induction)

ES MUEBLE CON HORNO ELÉCTRICO ESTÁTICO CM. 67X55X34H, TEMP: 50÷300°C, CON 1 PARILLA CM.65X53 GN2/1 (NO INDUCCIÓN)

cm. 100 x 63 x 57h

cm. 123 x 77 x 77h / kg 60 / m³ 0,729

€ 3.645,00
 5 kW
 400V~3N
 50/60 Hz

PIANI LAVORO - TOP
EN WORK TOP - TOP **DE** ARBEITSPLATTE - TOP **FR** PLAN DE TRAVAIL - TOP **ES** ENCIMERA DE TRABAJO - TOP

PLT-72

18010200



PIANO LAVORO (INCLUSA 1 TESTATA CHIUSURA PIANO MOD.TPA-7)

EN Worktop (included 1 Head end filler strip mod.TPA-7)

DE Arbeitsplatte (inbegriffen 1 Abschluss-Element mod.TPA-7)

FR Plan de travail (inclus 1 Elément de jonction top mod.TPA-7)

ES SOBRE DE TRABAJO (INCLUIDA 1 CHAPA DE CIERRE PARA TOP MOD. TPA-7)

cm. 20 x 70,5 x 28h

 cm. 43 x 77 x 54h / kg 15 / m³ 0,179

€ 633,00
PLST-73

18010301



cm. 30 x 70,5 x 28h

 cm. 43 x 77 x 54h / kg 20 / m³ 0,179

€ 675,00
PLST-74

18010401



cm. 40 x 70,5 x 28h

 cm. 43 x 77 x 54h / kg 22 / m³ 0,179

€ 693,00
PLST-76

18010601



cm. 60 x 70,5 x 28h

 cm. 63 x 77 x 54h / kg 27 / m³ 0,262

€ 903,00
PLST-78

18010801



cm. 80 x 70,5 x 28h

 cm. 83 x 77 x 54h / kg 33 / m³ 0,345

€ 1.028,00

PLT-73
18010300

PIANO LAVORO CASSETTO CON 1 BACINELLA: CM. 19X50X15H INOX (INCLUSA 1 TESTATA CHIUSURA PIANO MOD.TPA-7)

€ 968,00

- EN** Worktop Drawer with 1 container: cm. 19x50x15h inox (included 1 Head end filler strip mod.TPA-7)
- DE** Arbeitsplatte Schublade mit 1 Behälter: cm. 19x50x15h inox (inbegriffen 1 Abschluss-Element mod.TPA-7)
- FR** Plan de travail Tiroir avec 1 bac: cm. 19x50x15h inox (inclus 1 Élément de jonction top mod.TPA-7)

ES **SOBRE DE TRABAJO CAJÓN CON 1 CONTENEDORE: CM. 19X50X15H INOX (INCLUIDA 1 CHAPA DE CIERRE PARA TOP MOD.TPA-7)**

cm. 30 x 70,5 x 28h

cm. 43 x 77 x 54h / kg 23 / m³ 0,179

PLT-74
18010400

PIANO LAVORO CASSETTO CON 1 BACINELLA GN 1/1 15H INOX (INCLUSA 1 TESTATA CHIUSURA PIANO MOD.TPA-7)

€ 980,00

- EN** Worktop - Drawer with 1 inox container GN 1/1 15h (included 1 Head end filler strip mod.TPA-7)
- DE** Arbeitsplatte - Schublade mit 1 GN 1/1 15h aus Edelstahl (inbegriffen 1 Abschluss-Element mod.TPA-7)
- FR** Plan de travail - Tiroir avec bac en inox GN 1/1 15h (inclus 1 Élément de jonction top mod.TPA-7)

ES **SOBRE DE TRABAJO CAJÓN CON 1 CONTENEDOR GN 1/1 15H DE ACERO INOX (INCLUIDA 1 CHAPA DE CIERRE PARA TOP MOD.TPA-7)**

cm. 40 x 70,5 x 28h

cm. 43 x 77 x 54h / kg 26 / m³ 0,179

PLT-76
18010600

PIANO LAVORO CASSETTO CON 1 BACINELLA: CM. 49X50X15H INOX (INCLUSA 1 TESTATA CHIUSURA PIANO MOD.TPA-7)

€ 1.221,00

- EN** Worktop Drawer with 1 container: cm. 49x50x15h inox (included 1 Head end filler strip mod.TPA-7)
- DE** Arbeitsplatte Schublade mit 1 Behälter: cm. 49x50x15h inox (inbegriffen 1 Abschluss-Element mod.TPA-7)
- FR** Plan de travail Tiroir avec 1 bac: cm. 49x50x15h inox (inclus 1 Élément de jonction top mod.TPA-7)

ES **SOBRE DE TRABAJO CAJÓN CON 1 CONTENEDORE: CM. 49X50X15H INOX (INCLUIDA 1 CHAPA DE CIERRE PARA TOP MOD.TPA-7)**

cm. 60 x 70,5 x 28h

cm. 63 x 77 x 54h / kg 36 / m³ 0,262

PLT-78
18010800

PIANO LAVORO CASSETTO CON 2 BACINELLE GN 1/1 15H INOX (INCLUSA 1 TESTATA CHIUSURA PIANO MOD.TPA-7)

€ 1.378,00

- EN** Worktop - Drawer with 2 inox containers GN 1/1 15h (included 1 Head end filler strip mod.TPA-7)
- DE** Arbeitsplatte - Schublade mit 2 GN 1/1 15h aus Edelstahl (inbegriffen 1 Abschluss-Element mod.TPA-7)
- FR** Plan de travail - Tiroir avec 2 bacs en inox GN 1/1 15h (inclus 1 Élément de jonction top mod.TPA-7)

ES **SOBRE DE TRABAJO CAJÓN CON 2 CONTENEDORES GN 1/1 15H DE ACERO INOX (INCLUIDA 1 CHAPA DE CIERRE PARA TOP MOD.TPA-7)**

cm. 80 x 70,5 x 28h

cm. 83 x 77 x 54h / kg 43 / m³ 0,345

LAVELLI - TOP
EN SINK UNIT - TOP DE SPÜLBECKEN - TOP FR ÉVIER - TOP ES FREGADEROS - TOP
LAT-74
 18020400

LAVELLO RUBINETTO A LEVA - VASCA CM. 30X35X15H (INCLUSA 1 TESTATA CHIUSURA PIANO MOD.TPA-7)
€ 1.199,00
EN Sink unit - Lever type tap - Bowl cm. 30x35x15h (included 1 Head end filler strip mod.TPA-7)
DE Spülbecken - Einhebel-Mischbatterie Becken cm. 30x35x15h (inbegriffen 1 Abschluss-Element mod.TPA-7)
FR Bac-évier avec robinetterie - Bac cm 30x35x15h (inclus 1 Élément de jonction top mod.TPA-7)
ES FREGADERO - GRIFO A PALANCA - PILETA CM. 30X35X15H (INCLUIDA 1 CHAPA DE CIERRE PARA TOP MOD.TPA-7)

cm. 40 x 70,5 x 28h

 cm. 43 x 77 x 54h / kg 22 / m³ 0,179

70 SUPERLOTUS TOP TOUCH

70 SUPERLOTUS
TOP TOUCH



PIANI COTTURA A INDUZIONE - TOP - TOUCH

EN INDUCTION BOILING UNIT - TOP - TOUCH
 DE INDUKTIONNS-KOCHPLATTEN - TOP - TOUCH
 FR PLAN DE CUISSON À INDUCTION - TOP - TOUCH
 ES SOBRES DE COCCIÓN POR INDUCCIÓN - TOP - TOUCH

PCIT-74ETT
 1803A433

PIANO COTTURA INDUZIONE TRIFASE, TOUCH SCREEN 4,3" CON 10 LIVELLI DI POTENZA."ENERGY SAVING, WIFI E CLOUD". 2 TIMER. N. 2 ZONE - VETRO CM.35X57 (INCLUSA 1 TESTATA CHIUSURA PIANO MOD.TPA-7)

EN Three-phase induction cooking, Touch Screen 4,3" with 10 power levels. "Energy Saving, WiFi and CLOUD". Functions: 2 timer. 2 zones - glass cm.35x57 (included 1 Head end filler strip mod.tpa-7)

DE Induktions-Kochplatte dreiphasig, Touch Screen 4,3" mit 10 Leistungsstufen. "Energy Saving, WiFi und CLOUD". Funktionen: 2 timer. 2 zonen - Glas 35x57 cm (inbegriffen 1 Abschluss-Element mod.tpa-7)

FR Plan de cuisson à induction triphasé, Touch Screen 4,3" avec 10 niveaux de puissance. "Energy Saving, WiFi et CLOUD". Fonctions: 2 timer. N. 2 zones - Verre cm.35x57 (inclus 1 Élément de jonction top mod.tpa-7)

ES ENCIMERA INDUCCIÓN TRIFÁSICA, TOUCH SCREEN 4,3" CON 10 NIVELES DE POTENCIA. "ENERGY SAVING, WIFI Y CLOUD". FUNCIONES: 2 TIMER . - 2 ZONAS - VIDRIO CM.35X57 (INCLUIDA 1 CHAPA DE CIERRE PARA TOP MOD.TPA-7)

cm. 40 x 70,5 x 28h

cm. 43 x 77 x 54h / kg 34 / m³ 0,179

10 kW € 8.730,00
 400V~3N
 50/60 Hz

PCIWT-74ETT
 1803A434

PIANO COTTURA INDUZIONE TRIFASE "WOK", TOUCH SCREEN 4,3" CON 10 LIVELLI DI POTENZA."ENERGY SAVING, WIFI E CLOUD". 2 TIMER. N. 1 ZONA - VETRO Ø 30 CM. (INCLUSA 1 TESTATA CHIUSURA PIANO MOD.TPA-7)

EN Three-phase induction cooking "WOK", Touch Screen 4,3" with 10 power levels. "Energy Saving, WiFi and CLOUD". Functions: 2 timer. 1 zone - glass Ø 30 cm (included 1 Head end filler strip mod.tpa-7)

DE Induktions-Kochplatte "WOK" dreiphasig, Touch Screen 4,3" mit 10 Leistungsstufen. "Energy Saving, WiFi und CLOUD". Funktionen: 2 timer. 1 zonen - Glas Ø 30 cm (inbegriffen 1 Abschluss-Element mod.tpa-7)

FR Plan de cuisson à induction "WOK" triphasé, Touch Screen 4,3" avec 10 niveaux de puissance. "Energy Saving, WiFi et CLOUD". Fonctions: 2 timer. N. 1 zone - Verre cm Ø 30 (inclus 1 Élément de jonction top mod.tpa-7)

ES ENCIMERA INDUCCIÓN "WOK" TRIFÁSICA, TOUCH SCREEN 4,3" CON 10 NIVELES DE POTENCIA. "ENERGY SAVING, WIFI Y CLOUD". FUNCIONES: 2 TIMER . 1 ZONA - VIDRIO Ø 30 CM (INCLUIDA 1 CHAPA DE CIERRE PARA TOP MOD.TPA-7)

cm. 40 x 70,5 x 28h

cm. 43 x 77 x 54h / kg 32 / m³ 0,179

4,5 kW € 6.297,00
 400V~3N
 50/60 Hz

PCIT-78ETT
 1803A833

PIANO COTTURA INDUZIONE TRIFASE, TOUCH SCREEN 4,3" CON 10 LIVELLI DI POTENZA."ENERGY SAVING, WIFI E CLOUD". 2 TIMER. N. 4 ZONE - VETRO CM.75X57 (INCLUSA 1 TESTATA CHIUSURA PIANO MOD.TPA-7)

EN Three-phase induction cooking, Touch Screen 4,3" with 10 power levels. "Energy Saving, WiFi and CLOUD". Functions: 2 timer. 4 zones - glass cm.75x57 (included 1 Head end filler strip mod.tpa-7)

DE Induktions-Kochplatte dreiphasig, Touch Screen 4,3" mit 10 Leistungsstufen. "Energy Saving, WiFi und CLOUD". Funktionen: 2 timer. 4 zonen - Glas 75x57 cm (inbegriffen 1 Abschluss-Element mod.tpa-7)

FR Plan de cuisson à induction triphasé, Touch Screen 4,3" avec 10 niveaux de puissance. "Energy Saving, WiFi et CLOUD". Fonctions: 2 timer. N. 4 zones - Verre cm.75x57 (inclus 1 Élément de jonction top mod.tpa-7)

ES ENCIMERA INDUCCIÓN TRIFÁSICA, TOUCH SCREEN 4,3" CON 10 NIVELES DE POTENCIA. "ENERGY SAVING, WIFI Y CLOUD". FUNCIONES: 2 TIMER . 4 ZONAS - VIDRIO CM.75X57 (INCLUIDA 1 CHAPA DE CIERRE PARA TOP MOD.TPA-7)

cm. 80 x 70,5 x 28h

cm. 83 x 77 x 54h / kg 66 / m³ 0,345

20 kW € 16.240,00
 400V~3N
 50/60 Hz

TUTTAPIASTRA MULTIFUNZIONE ELETTRICO - TOP - TOUCH

EN ELECTRIC MULTIFUNCTION SOLID TOP - TOP - TOUCH DE ELEKTRO-MULTIFUNKTIONSKOCHPLATTEN - TOP - TOUCH FR TOUTE PLAQUE MULTIFONCTION ÉLECTRIQUE - TOP - TOUCH ES **PLACA DE COCCIÓN MULTIFUNCIÓN ELECTRICAS - TOP - TOUCH**

TPKT-78ETT
1812A830



TUTTA PIASTRA IN BIMETALLO PER COTTURE DIRETTE E INDIRECTE SU MOBILE A GIORNO, TOUCH SCREEN 4,3", TEMPERATURA 400°C CON CONTROLLO PID. "ENERGY SAVING, WIFI E CLOUD". FUNZIONI: 2 TIMER. PIASTRA CM. 71X48 - 4 ZONE (INCLUSA 1 TESTATA CHIUSURA PIANO MOD.TPA-7)

10 kW
400V~3N
50/60 Hz

€ 8.662,00

EN Compound Solid top for direct and indirect cooking on open unit, Touch Screen 4,3", temperature 400°C with PID control. "Energy Saving, WiFi and CLOUD".

Functions: 2 timer. Plate cm. 71x48 (included 1 Head end filler strip mod.tpa-7)

DE Compound Kochplatten zum direkten und indirekten Garen auf offenem Unterbau, Touch Screen 4,3", Temperatur 400°C mit PID-Regelung. "Energy Saving, WiFi und CLOUD". Funktionen: 2 timer. Platte cm. 71x48 (inbegriffen 1 Abschluss-Element mod.tpa-7)

FR Toute plaque en Compound pour la cuisson directe et indirecte sur meuble ouvert, Touch Screen 4,3", température 400°C avec contrôle PID. "Energy Saving, WiFi et CLOUD". Fonctions: 2 timer. Plaque cm. 71x48 (inclus 1 Élément de jonction top mod.tpa-7)

ES **PLACA RADIANTE EN COMPOUND PARA COCCIÓN DIRECTA E INDIRECTA SOBRE MUEBLE ABIERTO, TOUCH SCREEN 4,3", TEMPERATURA 400°C CON CONTROL PID. "ENERGY SAVING, WIFI Y CLOUD". FUNCIONES: 2 TIMER. PLACA CM. 71X48 (INCLUIDA 1 CHAPA DE CIERRE PARA TOP MOD.TPA-7)**

cm. 80 x 70,5 x 28h

cm. 83 x 77 x 54h / kg 110 / m³ 0,345

FRY-TOP ELETTRICI - TOP - TOUCH

EN ELECTRIC GRIDDLE - TOP - TOUCH DE ELEKTROGRIDDLEPLATTEN - TOP - TOUCH FR FRY-TOP ÉLECTRIQUE - TOP - TOUCH ES **FRY-TOP ELECTRICO - TOP - TOUCH**

FTLT-74ETTS
1806A434



FRY-TOP ELETTRICO LISCIO CROMATO SUPERCHROME (MOCA APPROVED), SU MOBILE A GIORNO, TOUCH SCREEN 4,3", TEMPERATURA 300°C CON CONTROLLO PID. "ENERGY SAVING, WIFI E CLOUD". FUNZIONI: 2 TIMER, SONDA AL CUORE PER COTTURE DIRETTE (OPTIONAL). PIASTRA CM.36X51 (INCLUSA 1 TESTATA CHIUSURA PIANO MOD.TPA-7)

5,55 kW
400V~3N
230V~3
50/60 Hz

€ 3.189,00

EN Electric Fry-top smooth chromed griddle SUPERCHROME (Moca Approved), on open cabinet, Touch Screen 4,3", temperature 300°C with PID control. "Energy Saving, WiFi and CLOUD". Functions: 2 timer, core probe for direct cooking (OPTIONAL). Plate cm.36x51 (included 1 Head end filler strip mod.tpa-7)

DE Griddleplatte elektrische glatt hartverchromt SUPERCHROME (Moca Approved), mit offenem Unterbau, Touch Screen 4,3", Temperatur 300°C mit PID-Regelung. "Energy Saving, WiFi und CLOUD". Funktionen: 2 timer, Kerntemperaturfühler für direktes Garen (OPTIONAL). Platte cm.36x51 (inbegriffen 1 Abschluss-Element mod.tpa-7)

FR Plaque électriques lisse chromée SUPERCHROME (Moca Approved), sur armoire ouvert, Touch Screen 4,3", température 300°C avec contrôle PID. "Energy Saving, WiFi et CLOUD". Fonctions: 2 timer, sonde à cœur pour cuisson directe (OPTIONAL). Plaque cm.36x51 (inclus 1 Élément de jonction top mod.tpa-7)

ES **FRY-TOP ELÉCTRICO LISO CROMADO SUPERCHROME (MOCA APPROVED), SOBRE MUEBLE ABIERTO, TOUCH SCREEN 4,3", TEMPERATURA 300°C CON CONTROL PID. "ENERGY SAVING, WIFI Y CLOUD". FUNCIONES: 2 TIMER, SONDA AL CORAZÓN PARA COCCIÓN DIRECTA (OPTIONAL). PLANCHA CM.36X51 (INCLUIDA 1 CHAPA DE CIERRE PARA TOP MOD.TPA-7)**

cm. 40 x 70,5 x 28h

cm. 43 x 77 x 54h / kg 58 / m³ 0,179

FTRT-74ETTS

1806A436



FRY-TOP ELETTRICO RIGATO CROMATO SUPERCHROME (MOCA APPROVED), SU MOBILE A GIORNO, TOUCH SCREEN 4,3", TEMPERATURA 300°C CON CONTROLLO PID. "ENERGY SAVING, WIFI E CLOUD". FUNZIONI: 2 TIMER, SONDA AL CUORE PER COTTURE DIRETTE (OPTIONAL). PIASTRA CM.36X51 (INCLUSA 1 TESTATA CHIUSURA PIANO MOD.TPA-7)

EN Electric Fry-top grooved chromed griddle SUPERCHROME (Moca Approved), on open cabinet, Touch Screen 4,3", temperature 300°C with PID control. "Energy Saving, WiFi and CLOUD". Functions: 2 timer, core probe for direct cooking (OPTIONAL). Plate cm.36x51 (included 1 Head end filler strip mod.tpa-7)

DE Griddleplatte elektrische gerillt hartverchromt SUPERCHROME (Moca Approved), mit offenem Unterbau, Touch Screen 4,3", Temperatur 300°C mit PID-Regelung. "Energy Saving, WiFi und CLOUD". Funktionen: 2 timer, Kerntemperaturfühler für direktes Garen (OPTIONAL). Platte cm.36x51 (inbegriffen 1 Abschluss-Element mod.tpa-7)

FR Plaque électriques nervurée chromée SUPERCHROME (Moca Approved), sur armoire ouvert, Touch Screen 4,3", température 300°C avec contrôle PID. "Energy Saving, WiFi et CLOUD". Fonctions: 2 timer, sonde à cœur pour cuisson directe (OPTIONAL). Plaque cm.36x51 (inclus 1 Élément de jonction top mod.tpa-7)

ES **FRY-TOP ELÉCTRICO ESTRIADO CROMADO SUPERCHROME (MOCA APPROVED), SOBRE MUEBLE ABIERTO, TOUCH SCREEN 4,3", TEMPERATURA 300°C CON CONTROL PID. "ENERGY SAVING, WIFI Y CLOUD". FUNCIONES: 2 TIMER, SONDA AL CORAZÓN PARA COCCIÓN DIRECTA (OPTIONAL). PLANCHA CM.36X51 (INCLUIDA 1 CHAPA DE CIERRE PARA TOP MOD.TPA-7)**

cm. 40 x 70,5 x 28h

cm. 43 x 77 x 54h / kg 58 / m³ 0,179

7,55 kW
400V~3N
230V~3
50/60 Hz

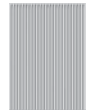
€ 3.347,00

FTLT-76ETTS

1806A634



FRY-TOP ELETTRICO LISCIO CROMATO SUPERCHROME (MOCA APPROVED), SU MOBILE A GIORNO, TOUCH SCREEN 4,3", TEMPERATURA 300°C CON CONTROLLO PID. "ENERGY SAVING, WIFI E CLOUD". FUNZIONI: 2 TIMER, SONDA AL CUORE PER COTTURE DIRETTE (OPTIONAL). PIASTRA CM.56X51 (INCLUSA 1 TESTATA CHIUSURA PIANO MOD.TPA-7)

EN Electric Fry-top smooth chromed griddle SUPERCHROME (Moca Approved), on open cabinet, Touch Screen 4,3", temperature 300°C with PID control. "Energy Saving, WiFi and CLOUD". Functions: 2 timer, core probe for direct cooking (OPTIONAL). Plate cm.56x51 (included 1 Head end filler strip mod.tpa-7)

DE Griddleplatte elektrische glatt hartverchromt SUPERCHROME (Moca Approved), mit offenem Unterbau, Touch Screen 4,3", Temperatur 300°C mit PID-Regelung. "Energy Saving, WiFi und CLOUD". Funktionen: 2 timer, Kerntemperaturfühler für direktes Garen (OPTIONAL). Platte cm.56x51 (inbegriffen 1 Abschluss-Element mod.tpa-7)

FR Plaque électriques lisse chromée SUPERCHROME (Moca Approved), sur armoire ouvert, Touch Screen 4,3", température 300°C avec contrôle PID. "Energy Saving, WiFi et CLOUD". Fonctions: 2 timer, sonde à cœur pour cuisson directe (OPTIONAL). Plaque cm.56x51 (inclus 1 Élément de jonction top mod.tpa-7)

ES **FRY-TOP ELÉCTRICO LISO CROMADO SUPERCHROME (MOCA APPROVED), SOBRE MUEBLE ABIERTO, TOUCH SCREEN 4,3", TEMPERATURA 300°C CON CONTROL PID. "ENERGY SAVING, WIFI Y CLOUD". FUNCIONES: 2 TIMER, SONDA AL CORAZÓN PARA COCCIÓN DIRECTA (OPTIONAL). PLANCHA CM.56X51 (INCLUIDA 1 CHAPA DE CIERRE PARA TOP MOD.TPA-7)**

cm. 60 x 70,5 x 28h

cm. 63 x 77 x 54h / kg 67 / m³ 0,262

7,4 kW
400V~3N
50/60 Hz

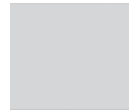
€ 3.721,00

FTLRT-76ETTS

1806A635



FRY-TOP ELETTRICO 1/2 RIGATO + 1/2 LISCIO CROMATO SUPERCHROME (MOCA APPROVED), SU MOBILE A GIORNO, TOUCH SCREEN 4,3", TEMPERATURA 300°C CON CONTROLLO PID. "ENERGY SAVING, WIFI E CLOUD". FUNZIONI: 2 TIMER, SONDA AL CUORE PER COTTURE DIRETTE (OPTIONAL). PIASTRA CM.56X51 (INCLUSA 1 TESTATA CHIUSURA PIANO MOD.TPA-7)

EN Electric Fry-top 1/2 grooved + 1/2 smooth chromed griddle SUPERCHROME (Moca Approved), on open cabinet, Touch Screen 4,3", temperature 300°C with PID control. "Energy Saving, WiFi and CLOUD". Functions: 2 timer, core probe for direct cooking (OPTIONAL). Plate cm.56x51 (included 1 Head end filler strip mod.tpa-7)

DE Griddleplatte elektrische 1/2 gerillt + 1/2 glatt hartverchromt SUPERCHROME (Moca Approved), mit offenem Unterbau, Touch Screen 4,3", Temperatur 300°C mit PID-Regelung. "Energy Saving, WiFi und CLOUD". Funktionen: 2 timer, Kerntemperaturfühler für direktes Garen (OPTIONAL). Platte cm.56x51 (inbegriffen 1 Abschluss-Element mod.tpa-7)

FR Plaque électriques 1/2 nervurée + 1/2 lisse chromée SUPERCHROME (Moca Approved), sur armoire ouvert, Touch Screen 4,3", température 300°C avec contrôle PID. "Energy Saving, WiFi et CLOUD". Fonctions: 2 timer, sonde à cœur pour cuisson directe (OPTIONAL). Plaque cm.56x51 (inclus 1 Élément de jonction top mod.tpa-7)

ES **FRY-TOP ELÉCTRICO 1/2 ESTRIADO + 1/2 LISO CROMADO SUPERCHROME (MOCA APPROVED), SOBRE MUEBLE ABIERTO, TOUCH SCREEN 4,3", TEMPERATURA 300°C CON CONTROL PID. "ENERGY SAVING, WIFI Y CLOUD". FUNCIONES: 2 TIMER, SONDA AL CORAZÓN PARA COCCIÓN DIRECTA (OPTIONAL). PLANCHA CM.56X51 (INCLUIDA 1 CHAPA DE CIERRE PARA TOP MOD.TPA-7)**

cm. 60 x 70,5 x 28h

cm. 63 x 77 x 54h / kg 67 / m³ 0,262

7,4 kW
400V~3N
50/60 Hz

€ 3.899,00

FTLT-78ETTS

1806A834



FRY-TOP ELETTRICO LISCIO CROMATO SUPERCHROME (MOCA APPROVED), SU MOBILE A GIORNO, TOUCH SCREEN 4,3", TEMPERATURA 300°C CON CONTROLLO PID. "ENERGY SAVING, WIFI E CLOUD". FUNZIONI: 2 TIMER, SONDA AL CUORE PER COTTURE DIRETTE (OPTIONAL). PIASTRA CM.76X51 - 2 ZONE DI COTTURA (INCLUSA 1 TESTATA CHIUSURA PIANO MOD.TPA-7)

EN Electric Fry-top smooth chromed griddle SUPERCHROME (Moca Approved), on open cabinet, Touch Screen 4,3", temperature 300°C with PID control. "Energy Saving, WiFi and CLOUD". Functions: 2 timer, core probe for direct cooking (OPTIONAL). Plate cm.76x51 - 2 cooking areas (included 1 Head end filler strip mod.tpa-7)

DE Griddleplatte elektrische glatt hartverchromt SUPERCHROME (Moca Approved), mit offenem Unterbau, Touch Screen 4,3", Temperatur 300°C mit PID-Regelung. "Energy Saving, WiFi und CLOUD". Funktionen: 2 timer, Kerntemperaturfühler für direktes Garen (OPTIONAL). Platte cm.76x51 - 2 Heizzonen (inbegriffen 1 Abschluss-Element mod.tpa-7)

FR Plaque électriques lisse chromée SUPERCHROME (Moca Approved), sur armoire ouvert, Touch Screen 4,3", température 300°C avec contrôle PID. "Energy Saving, WiFi et CLOUD". Fonctions: 2 timer, sonde à cœur pour cuisson directe (OPTIONAL). Plaque cm.76x51 - 2 zones de cuisson (inclus 1 Élément de jonction top mod.tpa-7)

ES **FRY-TOP ELÉCTRICO LISO CROMADO SUPERCHROME (MOCA APPROVED), SOBRE MUEBLE ABIERTO, TOUCH SCREEN 4,3", TEMPERATURA 300°C CON CONTROL PID. "ENERGY SAVING, WIFI Y CLOUD". FUNCIONES: 2 TIMER, SONDA AL CORAZÓN PARA COCCIÓN DIRECTA (OPTIONAL). PLANCHA CM.76X51 - 2 ZONAS DE COCCIÓN (INCLUIDA 1 CHAPA DE CIERRE PARA TOP MOD.TPA-7)**

cm. 80 x 70,5 x 28h

cm. 83 x 77 x 54h / kg 103 / m³ 0,345

11,1 kW
400V~3N
230V~3
50/60 Hz

€ 5.475,0070 SUPERLOTUS
TOP TOUCH**FTLRT-78ETTS**

1806A835



FRY-TOP ELETTRICO 1/2 RIGATO + 1/2 LISCIO CROMATO SUPERCHROME (MOCA APPROVED), SU MOBILE A GIORNO, TOUCH SCREEN 4,3", TEMPERATURA 300°C CON CONTROLLO PID. "ENERGY SAVING, WIFI E CLOUD". FUNZIONI: 2 TIMER, SONDA AL CUORE PER COTTURE DIRETTE (OPTIONAL). PIASTRA CM.76X51 - 2 ZONE DI COTTURA (INCLUSA 1 TESTATA CHIUSURA PIANO MOD.TPA-7)

EN Electric Fry-top 1/2 grooved + 1/2 smooth chromed griddle SUPERCHROME (Moca Approved), on open cabinet, Touch Screen 4,3", temperature 300°C with PID control. "Energy Saving, WiFi and CLOUD". Functions: 2 timer, core probe for direct cooking (OPTIONAL). Plate cm.76x51 - 2 cooking areas (included 1 Head end filler strip mod.tpa-7)

DE Griddleplatte elektrische 1/2 gerillt + 1/2 glatt hartverchromt SUPERCHROME (Moca Approved), mit offenem Unterbau, Touch Screen 4,3", Temperatur 300°C mit PID-Regelung. "Energy Saving, WiFi und CLOUD". Funktionen: 2 timer, Kerntemperaturfühler für direktes Garen (OPTIONAL). Platte cm.76x51 - 2 Heizzonen (inbegriffen 1 Abschluss-Element mod.tpa-7)

FR Plaque électriques 1/2 nervurée + 1/2 lisse chromée SUPERCHROME (Moca Approved), sur armoire ouvert, Touch Screen 4,3", température 300°C avec contrôle PID. "Energy Saving, WiFi et CLOUD". Fonctions: 2 timer, sonde à cœur pour cuisson directe (OPTIONAL). Plaque cm.76x51 - 2 zones de cuisson (inclus 1 Élément de jonction top mod.tpa-7)

ES **FRY-TOP ELÉCTRICO 1/2 ESTRIADO + 1/2 LISO CROMADO SUPERCHROME (MOCA APPROVED), SOBRE MUEBLE ABIERTO, TOUCH SCREEN 4,3", TEMPERATURA 300°C CON CONTROL PID. "ENERGY SAVING, WIFI Y CLOUD". FUNCIONES: 2 TIMER, SONDA AL CORAZÓN PARA COCCIÓN DIRECTA (OPTIONAL). PLANCHA CM.76X51 - 2 ZONAS DE COCCIÓN (INCLUIDA 1 CHAPA DE CIERRE PARA TOP MOD.TPA-7)**

cm. 80 x 70,5 x 28h

cm. 83 x 77 x 54h / kg 103 / m³ 0,345

11,1 kW
400V~3N
230V~3
50/60 Hz

€ 5.707,00**FTLT-712ETTS3**

1806B23E



FRY-TOP ELETTRICO LISCIO CROMATO SUPERCHROME (MOCA APPROVED), SU MOBILE A GIORNO, TOUCH SCREEN 4,3", TEMPERATURA 300°C CON CONTROLLO PID. "ENERGY SAVING, WIFI E CLOUD". FUNZIONI: 2 TIMER, SONDA AL CUORE PER COTTURE DIRETTE (OPTIONAL). PIASTRA CM.116X51 - 3 ZONE DI COTTURA (INCLUSA 1 TESTATA CHIUSURA PIANO MOD.TPA-7)

EN Electric Fry-top smooth chromed griddle SUPERCHROME (Moca Approved), on open cabinet, Touch Screen 4,3", temperature 300°C with PID control. "Energy Saving, WiFi and CLOUD". Functions: 2 timer, core probe for direct cooking (OPTIONAL). Plate cm.116x51 - 3 cooking areas (included 1 Head end filler strip mod.tpa-7)

DE Griddleplatte elektrische glatt hartverchromt SUPERCHROME (Moca Approved), mit offenem Unterbau, Touch Screen 4,3", Temperatur 300°C mit PID-Regelung. "Energy Saving, WiFi und CLOUD". Funktionen: 2 timer, Kerntemperaturfühler für direktes Garen (OPTIONAL). Platte cm.116x51 - 3 Heizzonen (inbegriffen 1 Abschluss-Element mod.tpa-7)

FR Plaque électriques lisse chromée SUPERCHROME (Moca Approved), sur armoire ouvert, Touch Screen 4,3", température 300°C avec contrôle PID. "Energy Saving, WiFi et CLOUD". Fonctions: 2 timer, sonde à cœur pour cuisson directe (OPTIONAL). Plaque cm.116x51 - 3 zones de cuisson (inclus 1 Élément de jonction top mod.tpa-7)

ES **FRY-TOP ELÉCTRICO LISO CROMADO SUPERCHROME (MOCA APPROVED), SOBRE MUEBLE ABIERTO, TOUCH SCREEN 4,3", TEMPERATURA 300°C CON CONTROL PID. "ENERGY SAVING, WIFI Y CLOUD". FUNCIONES: 2 TIMER, SONDA AL CORAZÓN PARA COCCIÓN DIRECTA (OPTIONAL). PLANCHA CM.116X51 - 3 ZONAS DE COCCIÓN (INCLUIDA 1 CHAPA DE CIERRE PARA TOP MOD.TPA-7)**

cm. 120 x 70,5 x 28h

cm. 123 x 77 x 54h / kg 114 / m³ 0,511

16,65 kW
400V~3N
50/60 Hz

€ 8.767,00

FTLRT-712ETTS3

1806B23F



FRY-TOP ELETTRICO 1/3 RIGATO + 2/3 LISCIO CROMATO SUPERCHROME (MOCA APPROVED), SU MOBILE A GIORNO, TOUCH SCREEN 4,3", TEMPERATURA 300°C CON CONTROLLO PID. "ENERGY SAVING, WIFI E CLOUD". FUNZIONI: 2 TIMER, SONDA AL CUORE PER COTTURE DIRETTE (OPTIONAL). PIASTRA CM.116X51 - 3 ZONE DI COTTURA (INCLUSA 1 TESTATA CHIUSURA PIANO MOD.TPA-7)

- EN** Electric Fry-top 1/3 grooved + 2/3 smooth chromed griddle SUPERCHROME (Moca Approved), on open cabinet, Touch Screen 4,3", temperature 300°C with PID control. "Energy Saving, WiFi and CLOUD". Functions: 2 timer, core probe for direct cooking (OPTIONAL). Plate cm.116x51 - 3 cooking areas (included 1 Head end filler strip mod.tpa-7)
- DE** Griddleplatte elektrische 1/3 gerillt + 2/3 glatt hartverchromt SUPERCHROME (Moca Approved), mit offenem Unterbau, Touch Screen 4,3", Temperatur 300°C mit PID-Regelung. "Energy Saving, WiFi und CLOUD". Funktionen: 2 timer, Kerntemperaturfühler für direktes Garen (OPTIONAL). Platte cm.116x51 - 3 Heizzonen (inbegriffen 1 Abschluss-Element mod.tpa-7)
- FR** Plaque électriques 1/3 nervurée + 2/3 lisse chromée SUPERCHROME (Moca Approved), sur armoire ouvert, Touch Screen 4,3", température 300°C avec contrôle PID. "Energy Saving, WiFi et CLOUD". Fonctions: 2 timer, sonde à cœur pour cuisson directe (OPTIONAL). Plaque cm.116x51 - 3 zones de cuisson (inclus 1 Élément de jonction top mod.tpa-7)
- ES** FRY-TOP ELÉCTRICO 1/3 ESTRIADO + 2/3 LISO CROMADO SUPERCHROME (MOCA APPROVED), SOBRE MUEBLE ABIERTO, TOUCH SCREEN 4,3", TEMPERATURA 300°C CON CONTROL PID. "ENERGY SAVING, WIFI Y CLOUD". FUNCIONES: 2 TIMER, SONDA AL CORAZÓN PARA COCCIÓN DIRECTA (OPTIONAL). PLANCHA CM.116X51 - 3 ZONAS DE COCCIÓN (INCLUIDA 1 CHAPA DE CIERRE PARA TOP MOD.TPA-7)

cm. 120 x 70,5 x 28h

cm. 123 x 77 x 54h / kg 114 / m³ 0,511

16,65 kW
400V~3N
50/60 Hz

€ 8.982,00

GRIGLIE ELETTRICHE - TOP - TOUCH

EN ELECTRIC GRILL - TOP - TOUCH **DE** ELEKTRO-WURSTBRATER - TOP - TOUCH **FR** CHARCOAL ÉLECTRIQUE - TOP - TOUCH **ES** BARBACOAS ELECTRICAS - TOP - TOUCH

CWKT-74ETT

1808A431



GRIGLIA CONTACT. TOUCH SCREEN 4,3", CON 10 LIVELLI DI POTENZA. "ENERGY SAVING, WIFI E CLOUD". FUNZIONI: 2 TIMER, SONDA AL CUORE PER COTTURE DIRETTE (OPTIONAL). COTTURA DIRETTA SU RESISTENZA IN ACCIAIO INOX CM. 27X43 RIBALTABILE (INCLUSA 1 TESTATA CHIUSURA PIANO MOD.TPA-7)

- EN** CONTACT Grill threephase on open cabinet. Touch Screen 4,3", with 10 power levels. "Energy Saving, WiFi and CLOUD". Functions: 2 timer, core probe for direct cooking (OPTIONAL). rotatable stainless steel grill cm. 27x43 (included 1 Head end filler strip mod.tpa-7)
- DE** Wurstbrater dreiphasig KONTAKT mit offenem Unterbau. Touch Screen 4,3", with 10 power levels. "Energy Saving, WiFi und CLOUD". Funktionen: 2 timer, Kerntemperaturfühler für direktes Garen (OPTIONAL). Drehbaren Heizelement aus Edelstahl cm. 27x43 (inbegriffen 1 Abschluss-Element mod.tpa-7)
- FR** Grillade triphase CONTACT sur armoire ouvert. Touch Screen 4,3", avec 10 niveaux de puissance. "Energy Saving, WiFi et CLOUD". Fonctions: 2 timer, sonde à cœur pour cuisson directe (OPTIONAL). Grille inox rotatif cm 27x43 (inclus 1 Élément de jonction top mod.tpa-7)
- ES** PARRILLA TRIFÁSICO CONTACT SOBRE MUEBLE ABIERTO. TOUCH SCREEN 4,3", CON 10 NIVELES DE POTENCIA. "ENERGY SAVING, WIFI Y CLOUD". FUNCIONES: 2 TIMER, SONDA AL CORAZÓN PARA COCCIÓN DIRECTA (OPTIONAL). PARRILLA GIRATORIA DE ACERO INOX CM 27X43 (INCLUIDA 1 CHAPA DE CIERRE PARA TOP MOD.TPA-7)

cm. 40 x 70,5 x 28h

cm. 43 x 77 x 54h / kg 55 / m³ 0,179

4,08 KW
400V~3N
50/60 Hz

€ 3.801,00
CWKT-78ETT

1808A831



GRIGLIA CONTACT. TOUCH SCREEN 4,3", CON 10 LIVELLI DI POTENZA. "ENERGY SAVING, WIFI E CLOUD". FUNZIONI: 2 TIMER, SONDA AL CUORE PER COTTURE DIRETTE (OPTIONAL). COTTURA DIRETTA SU RESISTENZA IN ACCIAIO INOX CM. 55X43 RIBALTABILE - 2 ZONE DI COTTURA (INCLUSA 1 TESTATA CHIUSURA PIANO MOD.TPA-7)

- EN** CONTACT Grill threephase on open cabinet. Touch Screen 4,3", with 10 power levels. "Energy Saving, WiFi and CLOUD". Functions: 2 timer, core probe for direct cooking (OPTIONAL). rotatable stainless steel grill cm. 55x43 - 2 cooking areas (included 1 Head end filler strip mod.tpa-7)
- DE** Wurstbrater dreiphasig KONTAKT mit offenem Unterbau. Touch Screen 4,3", with 10 power levels. "Energy Saving, WiFi und CLOUD". Funktionen: 2 timer, Kerntemperaturfühler für direktes Garen (OPTIONAL). Drehbaren Heizelement aus Edelstahl cm. 55x43 - 2 Heizzonen (inbegriffen 1 Abschluss-Element mod.tpa-7)
- FR** Grillade triphase CONTACT sur armoire ouvert. Touch Screen 4,3", avec 10 niveaux de puissance. "Energy Saving, WiFi et CLOUD". Fonctions: 2 timer, sonde à cœur pour cuisson directe (OPTIONAL). Grille inox rotatif cm 55x43 - 2 zones de cuisson (inclus 1 Élément de jonction top mod.tpa-7)
- ES** PARRILLA TRIFÁSICO CONTACT SOBRE MUEBLE ABIERTO. TOUCH SCREEN 4,3", CON 10 NIVELES DE POTENCIA. "ENERGY SAVING, WIFI Y CLOUD". FUNCIONES: 2 TIMER, SONDA AL CORAZÓN PARA COCCIÓN DIRECTA (OPTIONAL). PARRILLA GIRATORIA DE ACERO INOX CM 55X43 - 2 ZONAS DE COCCIÓN (INCLUIDA 1 CHAPA DE CIERRE PARA TOP MOD.TPA-7)

cm. 80 x 70,5 x 28h

cm. 83 x 77 x 54h / kg 85 / m³ 0,345

8,16 KW
400V~3N
50/60 Hz

€ 6.653,00

FRIGGITRICI ELETTRICHE - TOP - TOUCH

EN ELECTRIC FRYERS - TOP - TOUCH DE ELEKTRO-FRITEUSE - TOP - TOUCH FR FRITEUSE ÉLECTRIQUE - TOP - TOUCH ES FREIDORAS ELECTRICAS - TOP - TOUCH

F13T-74ETT
 1809A430

FRIGGITRICE TRIFASE LT. 13 VASCA CM. 30,5X34X22,5H - 1 CESTO CM. 28X29X10H. TOUCH SCREEN 4,3", TEMPERATURA MASSIMA 190°C CON CONTROLLO PID. "ENERGY SAVING, WIFI E CLOUD". FUNZIONI: 2 TIMER, MELTING. FILTRO E COPERCHIO VASCA - PROD. PATATE: 15 KG/H (INCLUSA 1 TESTATA CHIUSURA PIANO MOD.TPA-7)

EN Fryer threephase 13 lts. - Bowl cm. 30,5x34x22,5h 1 basket cm. 28x29x10h. Touch Screen 4,3", max temperature 190°C with PID control. "Energy Saving, WiFi and CLOUD". Functions: 2 timer, Melting. Sieve and lid for pan. Drip tray with sieve. Production: 15 kg/h (included 1 Head end filler strip mod.tpa-7)

DE Friteuse dreiphasig lt. 13 - Becken cm. 30,5x34x22,5h 1 Korb cm. 28x29x10h. Touch Screen 4,3", maximale Temperatur 190°C mit PID-Regelung. "Energy Saving, WiFi und CLOUD". Funktionen: 2 timer, Melting. Einlegesieb und Deckel für Becken. Fettauffangschale mit Sieb. Pommes frites: 15 kg/h (inbegriffen 1 Abschluss-Element mod.tpa-7)

FR Friteuse triphase lt. 13 - Cuve cm. 30,5x34x22,5h 1 Panier cm. 28x29x10h. Touch Screen 4,3", température maximale 190°C avec contrôle PID. "Energy Saving, WiFi et CLOUD". Fonctions: 2 timer, Melting. Filtre, couvercle pour cuve. Bac de récupération de l'huile avec filtre. Production de pommes frites: 15 kg/h (inclus 1 Élément de jonction top mod.tpa-7)

ES FREIDORAS TRIFÁSICO 13 LT. - CUBA CM. 30,5X34X22,5H 1 CESTA CM. 28X29X10H. TOUCH SCREEN 4,3", TEMPERATURA MÁXIMA 190°C CON CONTROL PID. "ENERGY SAVING, WIFI Y CLOUD". FUNCIONES: 2 TIMER, MELTING. FILTRO Y TAPA PARA CUBA. BANDEJA RECOGE ACEITE CON FILTRO. PRODUCCIÓN PATATAS: 15 KG/H (INCLUIDA 1 CHAPA DE CIERRE PARA TOP MOD.TPA-7)

cm. 40 x 70,5 x 28h

cm. 43 x 77 x 54h / kg 48 / m³ 0,179

10,95 kW
400V~3N
50/60 Hz

€ 3.150,00

F2/13T-78ETT
 1809A830

FRIGGITRICE TRIFASE LT. 13+13 2 VASCHE CM. 30,5X34X22,5H - 2 CESTI CM. 28X29X10H. TOUCH SCREEN 4,3", TEMPERATURA MASSIMA 190°C CON CONTROLLO PID. "ENERGY SAVING, WIFI E CLOUD". FUNZIONI: 2 TIMER, MELTING. 2X FILTRO E COPERCHIO VASCA - PROD. PATATE: 30 KG/H (INCLUSA 1 TESTATA CHIUSURA PIANO MOD.TPA-7)

EN Fryer threephase 13+13 lts - 2 Bowls cm. 30,5x34x22,5h 2 baskets cm. 28x29x10h. Touch Screen 4,3", max temperature 190°C with PID control. "Energy Saving, WiFi and CLOUD". Functions: 2 timer, Melting. 2 sieve and lids for pan. 2 drip trays with sieves. Production: 30 kg/h (included 1 Head end filler strip mod.tpa-7)

DE Friteuse dreiphasig lt. 13+13 - 2 Becken cm. 30,5x34x22,5h 2 Körbe cm. 28x29x10h. Touch Screen 4,3", maximale Temperatur 190°C mit PID-Regelung. "Energy Saving, WiFi und CLOUD". Funktionen: 2 timer, Melting. 2 Einlegesieb und Deckel für Becken. 2 Fettauffangschalen mit Sieb. Pommes frites: 30 kg/h (inbegriffen 1 Abschluss-Element mod.tpa-7)

FR Friteuse triphase lt. 13+13 - 2 cuves cm. 30,5x34x22,5h 2 paniers cm. 28x29x10h. Touch Screen 4,3", température maximale 190°C avec contrôle PID. "Energy Saving, WiFi et CLOUD". Fonctions: 2 timer, Melting. 2 filtres, couvercles pour cuve. 2 bacs de récupération de l'huile avec filtre. Production de pommes frites: 30 kg/h (inclus 1 Élément de jonction top mod.tpa-7)

ES FREIDORAS TRIFÁSICO 13+13 LT. - 2 CUBAS CM. 30,5X34X22,5H 2 CESTAS CM. 28X29X10H. TOUCH SCREEN 4,3", TEMPERATURA MÁXIMA 190°C CON CONTROL PID. "ENERGY SAVING, WIFI Y CLOUD". FUNCIONES: 2 TIMER, MELTING. 2 FILTROS Y TAPAS PARA CUBAS. 2 BANDEJAS RECOGE ACEITE CON FILTRO. PRODUCCIÓN PATATAS: 30 KG/H (INCLUIDA 1 CHAPA DE CIERRE PARA TOP MOD.TPA-7)

cm. 80 x 70,5 x 28h

cm. 83 x 77 x 54h / kg 75 / m³ 0,345

21,9 kW
400V~3N
50/60 Hz

€ 5.618,00

ACCESSORI - TOP - TOUCH
EN ACCESSORIES - TOP - TOUCH DE ZUBEHÖR - TOP - TOUCH FR ACCESSOIRES - TOP - TOUCH ES ACCESORIOS - TOP - TOUCH
SCCD-ST

0958A001



SONDA AL CUORE CON SPILLONE Ø4MM PER COTTURE DIRETTE SU "FT" E "BRF" E "CWK" E "BRM" TOUCH

EN Core probe Ø4mm for direct cooking on "FT" and "BRF" and "CWK" and "BRM" touch

DE Kerntemperaturfühler Ø4mm für direktes Garen auf "FT" und "BRF" und "CWK" und "BRM" touch

FR Sonde à cœur Ø4mm pour cuisson directe sur "FT" et "BRF" et "CWK" et "BRM" touch

ES Sonda al corazón Ø4mm para cocción directa en "FT" y "BRF" y "CWK" y "BRM" TOUCH

€ 233,00

cm. 25 x 15 x 5h / kg 0.2 / m³ 0,002

70 SUPERLOTUS TOP ACC70 SUPERLOTUS
TOP ACC

MOBILI BASE
EN STAND **DE** UNTERBAU **FR** MEUBLE NEUTRE **ES** MUEBLE

MPI-74

08410403



BASE CON PORTA PER INDUZIONE

EN Stand with door for induction top

DE Unterbau für Induktions mit Tür

FR Placard pour induction avec porte

ES MUEBLE BASE PARA INDUCCIÓN CON PUERTA

cm. 40 x 62 x 57h

 cm. 43 x 77 x 65h / kg 20 / m³ 0,215

€ 743,00
MPI-78

08410803



cm. 80 x 62 x 57h

 cm. 83 x 77 x 65h / kg 30 / m³ 0,415

€ 849,00
M-72

08410200



BASE NEUTRA

EN Stand

DE Unterbau

FR Placard

ES MUEBLE BASE

cm. 20 x 59,5 x 57h

 cm. 73 x 63 x 37h / kg 12 / m³ 0,170

€ 456,00
M-73

08410300



BASE NEUTRA A GIORNO

EN Open Stand

DE Offener Unterbau

FR Placard ouvert

ES MUEBLE BASE ABIERTO

cm. 30 x 59,5 x 57h

 cm. 43 x 77 x 63h / kg 14 / m³ 0,209

€ 457,00
M-74

08410400

cm. 40 x 59,5 x 57h

 cm. 43 x 77 x 63h / kg 17 / m³ 0,209

€ 463,00

M-76
08410600

cm. 60 x 59,5 x 57h
 cm. 63 x 77 x 63h / kg 21 / m³ 0,306

€ 521,00



M-78
08410800

cm. 80 x 59,5 x 57h
 cm. 83 x 77 x 63h / kg 24 / m³ 0,403

€ 559,00

M-712
08411200

BASE NEUTRA A GIORNO 40/80
EN Open Stand 40/80
DE Offener Unterbau 40/80
FR Placard ouvert 40/80
ES MUEBLE BASE ABIERTO 40/80
 cm. 120 x 59,5 x 57h
 cm. 83 x 77 x 63h / kg 35 / m³ 0,403

€ 797,00



M-716
08411600

BASE NEUTRA A GIORNO 80/80
EN Open Stand 80/80
DE Offener Unterbau 80/80
FR Placard ouvert 80/80
ES MUEBLE BASE ABIERTO 80/80
 cm. 160 x 59,5 x 57h
 cm. 163 x 77 x 63h / kg 52 / m³ 0,791

€ 953,00



MPIH2-74
0841040D

BASE IGENICA "H2" CON PORTA PER INDUZIONE
EN Hygienic "H2" Stand with door for induction top
DE Hygieneständer "H2" für Induktions mit Tür
FR Placard hygiénique "H2" pour induction avec porte
ES MUEBLE BASE HIGIÉNICO "H2" PARA INDUCCIÓN CON PUERTA
 cm. 40 x 62 x 57h
 cm. 43 x 77 x 65h / kg 28 / m³ 0,215

€ 1.380,00



MPIH2-78
0841080D

cm. 80 x 62 x 57h
 cm. 83 x 77 x 65h / kg 42 / m³ 0,415

€ 1.732,00



MH2-74

0841040A



BASE IGENICA "H2" NEUTRA A GIORNO

- EN** Open Hygienic "H2" Stand
- DE** Offener Hygieneständer "H2"
- FR** Placard hygiénique "H2" ouvert
- ES** **MUEBLE BASE HIGIÉNICO "H2" ABIERTO**

cm. 40 x 59,5 x 57h

 cm. 43 x 77 x 63h / kg 25 / m³ 0,209

€ 1.215,00
MH2-76

0841060A



cm. 60 x 59,5 x 57h

 cm. 83 x 77 x 63h / kg 31 / m³ 0,403

€ 1.248,00
MH2-78

0841080A

cm. 80 x 59,5 x 57h

 cm. 83 x 77 x 63h / kg 36 / m³ 0,403

€ 1.377,00
ACCESSORI TOP
EN ACCESSORIES - TOP **DE** ZUBEHÖR - TOP **FR** ACCESSOIRES - TOP **ES** **ACCESORIOS - TOP**
PT-POTS

STRUTTURA PORTATEGAMI PER S70 E S90 (REALIZZAZIONI A PROGETTO)

- EN** pot rack structure for S70 / S90 (realizations for project)
- DE** Ablagerost für Kochwerkzeuge, für S70 / S90 (Realisierungen im Projekt)
- FR** structures porte casseroles pour S70 / S90 (réalisations en projet)
- ES** **ESTRUCTURAS SUPERIORES PORTA CAZUELAS PARA S70 / S90 (LOGROS EN EL PROYECTO)**

€/m xcm. 70 x 75h

€ 1.512,00
PT-POTS-SL



STRUTTURA PORTATEGAMI PER S70 E S90 CON ABBASSAMENTO PORTASALAMANDRA (REALIZZAZIONI A PROGETTO)

- EN** pot rack structure for S70 / S90 with salamander support (realizations for project)
- DE** Ablagerost für Kochwerkzeuge, für S70 / S90 mit Salamander Konsolen (Realisierungen im Projekt)
- FR** structures porte casseroles pour S70 / S90 avec porte salamandres (réalisations en projet)
- ES** **ESTRUCTURAS SUPERIORES PORTA CAZUELAS PARA S70 / S90 CON PORTA SALAMANDRA (LOGROS EN EL PROYECTO)**

€/m xcm. 70 x 75h

€ 1.620,00

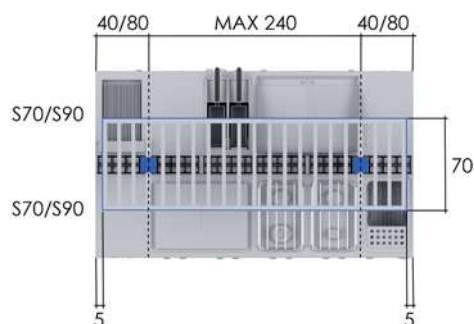
NO CM.20/30/60



PM-63/73/93-DX

08430302



PORTA 300 DESTRA

EN Right door 300**DE** Rechte tür 300**FR** Porte droite 300**ES** **PUERTA DERECHA 300**

↙ cm. 29,5 x 2,5 x 47,5h

📦 cm. 33 x 7 x 58h / kg 3 / m³ 0,013

€ 219,00

PM-64/74/94-DX

08430402

PORTA 400 DESTRA

EN Right door 400**DE** Rechte tür 400**FR** Porte droite 400**ES** **PUERTA DERECHA 400**

↙ cm. 39,5 x 2,5 x 47,5h

📦 cm. 43 x 7 x 58h / kg 3.5 / m³ 0,017

€ 227,00

PM-63/73/93-SX

08430303



PORTA 300 SINISTRA

EN Left door 300**DE** Linke tür 300**FR** Porte gauche 300**ES** **PUERTA IZQUIERDA 300**

↙ cm. 29,5 x 2,5 x 47,5h

📦 cm. 33 x 7 x 58h / kg 3 / m³ 0,013

€ 219,00

PM-64/74/94-SX

08430403

PORTA 400 SINISTRA

EN Left door 400**DE** Linke tür 400**FR** Porte gauche 400**ES** **PUERTA IZQUIERDA 400**

↙ cm. 39,5 x 2,5 x 47,5h

📦 cm. 43 x 7 x 58h / kg 3.5 / m³ 0,017

€ 227,00

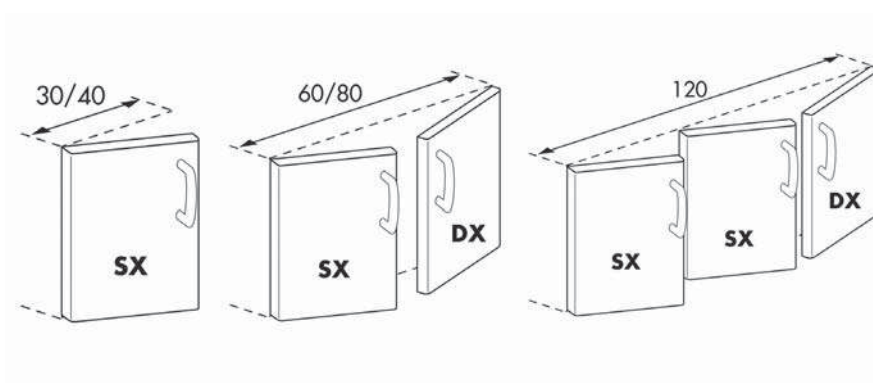

C-73/93

08440320



CASSETTIERA 300 N. 2 CASSETTI CON 2 BACINELLE INOX, GUIDE TELESCOPICHE.

€ 852,00
EN Drawer set 300 N. 2 drawers with 2 inox containers, telescopic guides.

DE Schubladen 300 - N. 2 Schubladen mit 2 Chromnickelstahlbehältern, Telescopeinführungen.

FR Tiroirs pour meuble de 300 N. 2 tiroirs avec 2 bacs inox, guides télescopiques.

ES CAJONERA 300 - N. 2 CAJONES CON 2 CONTENEDORES DE ACERO INOX, GUÍAS TELESCÓPICAS.

cm. 29,5 x 59 x 47,5h

 cm. 43 x 69 x 65h / kg 16 / m³ 0,193

C-74/94

08440420



CASSETTIERA 400 - N. 2 CASSETTI CON 2 BACINELLE GN 1/1 15H IN INOX, GUIDE TELESCOPICHE.

€ 875,00
EN Drawer set 400 - N. 2 drawers with 2 GN 1/1 15h inox containers, telescopic guides.

DE Schubladen 400 - N. 2 Schubladen mit 2 GN 1/1 15h aus Edelstahl, Telescopeinführungen.

FR Tiroirs pour meuble de 400 - N. 2 tiroirs avec 2 bacs en inox GN 1/1 15h, guides télescopiques.

ES CAJONERA 400 - N. 2 CAJONES CON 2 CONTENEDORES GN 1/1 15H DE DE ACERO INOX, GUÍAS TELESCÓPICAS.

cm. 39,5 x 59 x 47,5h

 cm. 43 x 69 x 65h / kg 18 / m³ 0,193

C-76/96

08440620



CASSETTIERA 600 N. 2 CASSETTI CON 2 BACINELLE INOX, GUIDE TELESCOPICHE.

€ 1.209,00
EN Drawer set 600 N. 2 drawers with 2 inox containers, telescopic guides.

DE Schubladen 600 - N. 2 Schubladen mit 2 Chromnickelstahlbehältern, Telescopeinführungen.

FR Tiroirs pour meuble de 600 N. 2 tiroirs avec 2 bacs inox, guides télescopiques.

ES CAJONERA 600 - N. 2 CAJONES CON 2 CONTENEDORES DE ACERO INOX, GUÍAS TELESCÓPICAS.

cm. 59,5 x 59 x 47,5h

 cm. 63 x 69 x 65h / kg 22 / m³ 0,283

C-78/98

08440820



CASSETTIERA 800 - N. 2 CASSETTI CON 4 BACINELLE GN 1/1 15H IN INOX, GUIDE TELESCOPICHE.

€ 1.229,00
EN Drawer set 800 - N. 2 drawers with 4 GN 1/1 15h inox containers, telescopic guides.

DE Schubladen 800 - N. 2 Schubladen mit 4 GN 1/1 15h aus Edelstahl, Telescopeinführungen.

FR Tiroirs pour meuble de 800 - N. 2 tiroirs avec 4 bacs en inox GN 1/1 15h, guides télescopiques.

ES CAJONERA 800 - N. 2 CAJONES CON 4 CONTENEDORES GN 1/1 15H DE DE ACERO INOX, GUÍAS TELESCÓPICAS.

cm. 79,5 x 59 x 47,5h

 cm. 83 x 69 x 65h / kg 26 / m³ 0,372

CH2-74/94

0844042A



CASSETTIERA PER BASE IGENICA "H2" - N. 2 CASSETTI CON 2 BACINELLE GN 1/1 15H, GUIDE TELESCOPICHE.

€ 916,00
EN Drawer set for Hygienic "H2" Stand - N. 2 drawers with 2 GN 1/1 15h containers, telescopic guides.

DE Schubladen für Hygieneständer "H2" - N. 2 Schubladen mit 2 GN 1/1 15h, Telescopeinführungen.

FR Tiroirs pour meuble hygiénique "H2" - N. 2 tiroirs avec 2 bacs GN 1/1 15h, guides télescopiques.

ES CAJONERA PARA MUEBLE BASE HIGIÉNICO "H2" - N. 2 CAJONES CON 2 CONTENEDORES GN 1/1 15H, GUÍAS TELESCÓPICAS.

cm. 39,5 x 59 x 47,5h

 cm. 43 x 69 x 65h / kg 18 / m³ 0,193

CH2-76/96

0844062A



CASSETTIERA PER BASE IGENICA "H2" - N. 2 CASSETTI CON 2 BACINELLE INOX, GUIDE TELESCOPICHE.

EN Drawer set for Hygienic "H2" Stand - N. 2 drawers with 2 inox containers, telescopic guides.

DE Schubladen für Hygieneständer "H2" - N. 2 Schubladen mit 2 Chromnickelstahlbehältern, Telescopeinführungen.

FR Tiroirs pour meuble hygiénique "H2" - N. 2 tiroirs avec 2 bacs inox, guides télescopiques.

ES CAJONERA PARA MUEBLE BASE HIGIÉNICO "H2" - N. 2 CAJONES CON 2 CONTENEDORES DE ACERO INOX, GUÍAS TELESCÓPICAS.

cm. 59,5 x 59 x 47,5h

cm. 63 x 69 x 65h / kg 22 / m³ 0,283

€ 1.244,00

CH2-78/98

0844082A



CASSETTIERA PER BASE IGENICA "H2" - N. 2 CASSETTI CON 4 BACINELLE GN 1/1 15H, GUIDE TELESCOPICHE.

EN Drawer set for Hygienic "H2" Stand - N. 2 drawers with 4 GN 1/1 15h containers, telescopic guides.

DE Schubladen für Hygieneständer "H2" - N. 2 Schubladen mit 4 GN 1/1 15h, Telescopeinführungen.

FR Tiroirs pour meuble hygiénique "H2" - N. 2 tiroirs avec 4 bacs GN 1/1 15h, guides télescopiques.

ES CAJONERA PARA MUEBLE BASE HIGIÉNICO "H2" - N. 2 CAJONES CON 4 CONTENEDORES GN 1/1 15H, GUÍAS TELESCÓPICAS.

cm. 79,5 x 59 x 47,5h

cm. 83 x 69 x 65h / kg 26 / m³ 0,372

€ 1.287,00

D-70

08470001



DIVISORIO BASE NEUTRA

EN Spacer for stand

DE Trennwand für offener unterbau

FR Separation pour placard ouvert

ES DIVISORIO PARA MUEBLE BASE

cm. 5 x 58 x 38h

cm. 7 x 60 x 44h / kg 2.5 / m³ 0,018

€ 183,00

R-74

08450400



RIPIANO 400

EN Shelf 400

DE Zwischenboden 400

FR Étagère 400

ES ESTANTE 400

cm. 35 x 59 x 3,5h

cm. 37 x 61 x 4h / kg 2 / m³ 0,009

€ 140,00

R-76

08450600

RIPIANO 600

EN Shelf 600

DE Zwischenboden 600

FR Étagère 600

ES ESTANTE 600

cm. 55 x 59 x 3,5h

cm. 57 x 61 x 4h / kg 3 / m³ 0,014

€ 159,00

R-78

08450800



RIPIANO 800

EN Shelf 800

DE Zwischenboden 800

FR Étagère 800

ES ESTANTE 800

cm. 75 x 59 x 3,5h

cm. 77 x 61 x 4h / kg 3.5 / m³ 0,019

€ 177,00

RH2-74

0845040A



RIPIANO PER BASE IGENICA "H2"

- EN** Shelf for Hygienic "H2" Stand
- DE** Zwischenboden für Hygieneständer "H2"
- FR** Etagère pour meuble hygiénique "H2"
- ES** **ESTANTE PARA MUEBLE BASE HIGIÉNICO "H2"**

- cm. 35 x 55 x 3h
- cm. 37 x 57 x 5h / kg 2 / m³ 0,011

€ 286,00
RH2-76

0845060A

- cm. 55 x 55 x 3h
- cm. 57 x 57 x 5h / kg 3 / m³ 0,016

€ 324,00
RH2-78

0845080A



- cm. 75 x 55 x 3h
- cm. 77 x 57 x 5h / kg 5 / m³ 0,022

€ 340,00
PT-74/94

08460002



PORTATEGLIE VANO 400/600 (GN-1/1) 4 RIPIANI INT. 7 CM.

- EN** Frame for plates 400/600 (GN-1/1) - N. 4 shelves, wheel-base 7 cm.
- DE** Auflangeschienen für bleche 400/600 (GN-1/1) N. 4 Etagen, Abstand 7 cm.
- FR** Kit porte-plaques 400/600 (GN-1/1) - N. 4 étagères; 7 cm.
- ES** **PORTACAZUELAS 400/600 (GN-1/1) - N. 4 ESTANTES, INT. 7 CM.**

- cm. 5 x 60 x 32h / kg 2.5 / m³ 0,010

€ 473,00
PT-78/98

08460012

PORTATEGLIE VANO 800 (GN-2/1) 4 RIPIANI INT. 7 CM.

- EN** Frame for plates 800 (GN-2/1) 4 Etagen, Abstand 7 cm.
- DE** Auflangeschienen für bleche 800 (GN-2/1) N. 4 Etagen, Abstand 7 cm.
- FR** Kit porte-plaques 800 (GN-2/1) - N. 4 étagères; 7 cm.
- ES** **PORTACAZUELAS 800 (GN-2/1) - N. 4 ESTANTES, INT. 7 CM.**

- cm. 5 x 60 x 32h / kg 4 / m³ 0,010

€ 632,00
OPT-GA

ACCENSIONE ELETTRICA PER APPARECCHI GAS: PCT-74GA, PCT-78GA, PCT-712GA (PREZZO A BRUCIATORE)

- EN** electric ignition for gas model: PCT-74GA, PCT-78GA, PCT-712GA (PRICE FOR 1 BURNER)
- DE** elektrische Zündung für gas modell: PCT-74GA, PCT-78GA, PCT-712GA (PREIS FÜR 1 BRENNER)
- FR** allumage électrique pour modèle a gaz: PCT-74GA, PCT-78GA, PCT-712GA (PRIX POUR 1 BRÛLEUR)
- ES** **IGNICIÓN ELÉCTRICA PARA MODELO GAS: PCT-74GA, PCT-78GA, PCT-712GA (PRECIO POR 1 QUEMADOR)**

⚡	0,01 KW
	230V~
	50/60 Hz

€ 270,00

532005901



GRIGLIA 1 FUOCO
EN 1 flame grill
DE Rost 1 flamme
FR Frille 1 feu
ES **PARILLA 1 QUEMADOR**

€ 119,00

cm. 40 x 30 x 10h / kg 3 / m³ 0,012

533009200



GRIGLIA DI RIDUZIONE
EN Reduction
DE Reduzierstern
FR Grille de réduction
ES **REJILLA DE REDUCCIÓN**

€ 44,00

cm. 25 x 25
 cm. 28 x 28 x 2h / kg 0.2 / m³ 0,002

KIT-WOK

09580040



KIT WOK - FIAMMA VERTICALE - SOLO SU BRUCIATORE DA 10 KW E GRIGLIE IN GHISA

€ 470,00

EN KIT WOK - vertical flame - only for 10 kW burner and cast iron grills
DE KIT WOK - vertikaler Flamme - nur 10 kW-Brenner und Roste aus Gusseisen
FR KIT WOK - verticale de la flamme - seulement 10 kW brûleur et grilles en fonte
ES **KIT WOK - LLAMA VERTICAL - SÓLO 10 KW QUEMADOR Y PARRILAS DE HIERRO COLADO**

cm. Ø 26 x 16h
 cm. 27 x 27 x 20h / kg 5 / m³ 0,015

CEAT

19580010



COLONNINA EROGAZIONE ACQUA TOP

€ 473,00

EN Pillar tap top
DE Mischbatterie top
FR Colonne de distribution eau top
ES **RUBINETO DISPENSADOR DE AGUA TOP**

cm. 81 x 40 x 11h / kg 5 / m³ 0,036

S70/90	S70T/90T	
BM	BMT	E/G
BRF		E/G
CF		E/G
CW	CWT	E/G
CWK	CWKT	E
FT	FTT	E/G
PA	PAT	G
PAF		G
PC	PCT	E/G
PCC	PCCT	E
PCI	PCIT	E
TP	TPT	E/G
TPF		E/G
TPI	TPIRT	E
PL	PLT	

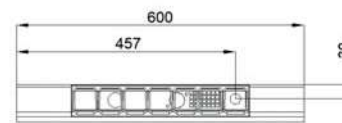
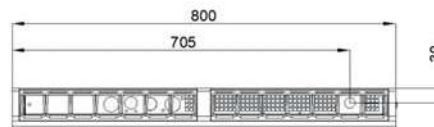
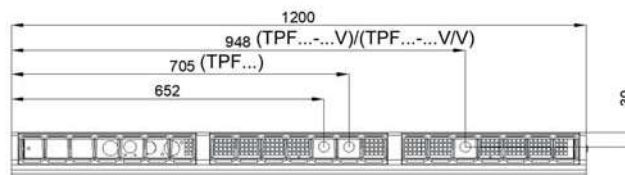
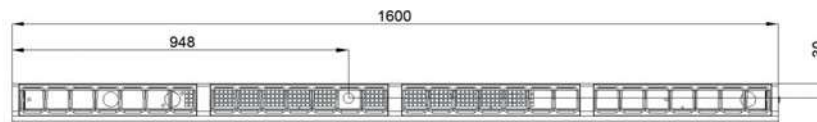

Model cm.40
 mm.248 = BM-E / BMT-E / BS-94E / BST-94E
 CW-E / CWT-E / CWK-E / CWKT-E
 FT-E / FTT-E / PC-E / PCT-E / PCC-E
 PCCT-E / CP-E / CPT-E / BRF-E / PCI-E
 PCIT-E / PL / PLT
 mm.95 = BM-G / CW-G / PC-G / TP-G

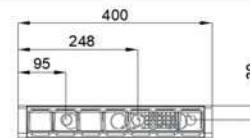

PLF

07590401



PIASTRA LISCIA PER GRIGLIA IN GHISA

- EN** Smooth griddle plate for cast iron grid
- DE** Fortkochplatte glatt für Gusseisen Rost
- FR** Plaque lisse pour la grille en fonte

ES PLANCHA LISA PARA REJILLA DE HIERRO FUNDIDO

cm. 35 x 27

 cm. 38 x 30 x 6h / kg 9 / m³ 0,007

€ 212,00
PLF/2

07590421



PIASTRA LISCIA 2 FUOCHI PER GRIGLIA IN GHISA

- EN** Smooth griddle plate 2 burners for cast iron grid
- DE** Fortkochplatte glatt 2 Kochstellen für Gusseisen Rost
- FR** Plaque lisse 2 feux pour la grille en fonte

ES PLANCHA LISA 2 QUEMADORES PARA REJILLA DE HIERRO FUNDIDO

cm. 35 x 57

 cm. 38 x 60 x 6h / kg 18 / m³ 0,014

€ 417,00
PRF

07590403



PIASTRA RIGATA PER GRIGLIA IN GHISA

- EN** Grooved griddle plate for cast iron grid
- DE** Fortkochplatte gerillt für Gusseisen Rost
- FR** Plaque nervurée pour la grille en fonte

ES PLANCHA ESTRIADA PARA REJILLA DE HIERRO FUNDIDO

cm. 35 x 27

 cm. 38 x 30 x 6h / kg 9 / m³ 0,007

€ 283,00
PRF/2

07590423



PIASTRA RIGATA 2 FUOCHI PER GRIGLIA IN GHISA

- EN** Grooved griddle plate 2 burners for cast iron grid
- DE** Fortkochplatte gerillt 2 Kochstellen für Gusseisen Rost
- FR** Plaque nervurée 2 feux pour la grille en fonte

ES PLANCHA ESTRIADA 2 QUEMADORES PARA REJILLA DE HIERRO FUNDIDO

cm. 35 x 57

 cm. 38 x 60 x 6h / kg 18 / m³ 0,014

€ 464,00
PLFT/7

08590451



PIASTRA LISCIA PER GRIGLIA IN TONDINO

- EN** Smooth griddle plate for grid rod
- DE** Fortkochplatte glatt für Gitterstab
- FR** Plaque lisse pour tige grille

ES PLANCHA LISA POR RED DE VARILLA

cm. 35 x 27

 cm. 38 x 30 x 6h / kg 9 / m³ 0,007

€ 212,00
PLFT/72

08590471



PIASTRA LISCIA 2 FUOCHI PER GRIGLIA IN TONDINO

- EN** Smooth griddle plate 2 burners for grid rod
- DE** Fortkochplatte glatt 2 Kochstellen für Gitterstab
- FR** Plaque lisse 2 feux pour tige grille

ES PLANCHA LISA 2 QUEMADORES POR RED DE VARILLA

cm. 35 x 57

 cm. 38 x 60 x 6h / kg 18 / m³ 0,014

€ 417,00
PRFT/7

08590453



PIASTRA RIGATA PER GRIGLIA IN TONDINO

- EN** Grooved griddle plate for grid rod
- DE** Fortkochplatte gerillt für Gitterstab
- FR** Plaque nervurée pour tige grille

ES PLANCHA ESTRIADA POR RED DE VARILLA

cm. 35 x 27

 cm. 38 x 30 x 6h / kg 9 / m³ 0,007

€ 283,00

PRFT/72

08590473



PIASTRA RIGATA 2 FUOCHI PER GRIGLIA IN TONDINO

- EN** Grooved griddle plate 2 burners for grid rod
- DE** Fortkochplatte gerillt 2 Kochstellen für Gitterstab
- FR** Plaque nervurée 2 feux pour tige grille

ES PLANCHA ESTRIADA 2 QUEMADORES POR RED DE VARILLA

↙ cm. 35 x 57

📦 cm. 38 x 60 x 6h / kg 18 / m³ 0,014**€ 464,00****RV**

08660410



RISCALDANTE VANO

- EN** Heater for cabinet
- DE** Heizer für Schrankelement
- FR** Réchauffeur pour armoire

ES ELEMENTO DE CALEFACCIÓN PARA ARMARIO NEUTRO

↙ cm. 32 x 48,5 x 8h

📦 cm. 48 x 62 x 28h / kg 8 / m³ 0,083
 ⚡ 0,75 kW
 230V~
 50/60 Hz
€ 1.004,00**RRV-74**

08450401



RIPIANO FORATO IN APPOGGIO PER RISCALDANTE

- EN** Perforated shelf for heater element mod.RV
- DE** regale Gelocht für Heizer mod.RV
- FR** Étagère perforées pour réchauffeur mod.RV

ES ESTANTE PERFORADO PARA ELEMENTO DE CALEFACCIÓN MOD.RV

↙ cm. 34 x 57 x 10h

📦 cm. 37 x 60 x 13h / kg 5 / m³ 0,029**€ 391,00****RRV-76**

08450601

↙ cm. 54 x 57 x 10h

📦 cm. 57 x 60 x 13h / kg 7 / m³ 0,044**€ 599,00****RRV-78**

08450801

↙ cm. 74 x 57 x 10h

📦 cm. 77 x 60 x 13h / kg 9 / m³ 0,060**€ 861,00****RRV-710**

08451001



↙ cm. 94 x 57 x 10h

📦 cm. 97 x 60 x 13h / kg 11 / m³ 0,076**€ 1.079,00****RRV-712**

08451201

↙ cm. 114 x 57 x 10h

📦 cm. 117 x 60 x 13h / kg 14 / m³ 0,091**€ 1.381,00****RRV-716**

08451601

↙ cm. 154 x 57 x 10h

📦 cm. 157 x 60 x 13h / kg 18 / m³ 0,122**€ 1.758,00**

SIA-7/9

08480000

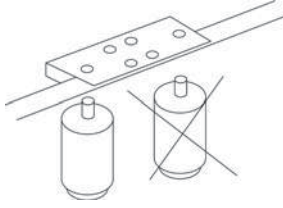

STAFFA INFERIORE UNIONE APPARECCHI

- EN** Lower bracket to join two items
- DE** Unterer Halter zur Verbindung zweier Teile
- FR** Support inférieur permettant d'assembler deux éléments
- ES** **SOPORTE INFERIOR PARA UNIR DOS ELEMENTOS**

 cm. 21 x 11 x 10h / kg 2 / m³ 0,002

€ 66,00
SR-100

50900001

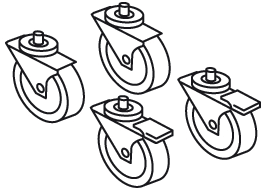

SET 4 RUOTE Ø 100X30, 2 CON FRENO

- EN** Set of 4 wheels Ø 100x30, 2 with brake
- DE** 4 Rollen Satz Ø 100x30, 2 davon mit Feststellbremse
- FR** Kit 4 roues Ø 100x30, 2 avec frein
- ES** **EQUIPO 4 RUEDAS Ø 100X30, 2 CON FRENOS**

cm. 12,7h

 cm. 30 x 20 x 20h / kg 1 / m³ 0,012

€ 395,00
ZB

01410000



ZOCCOLATURA BASE

- EN** FRONT PLINTH
- DE** GRUNDSOCKEL
- FR** PLINTHE FRONTAL
- ES** **ZOCOLOS BASE**

€/m x cm. 15h

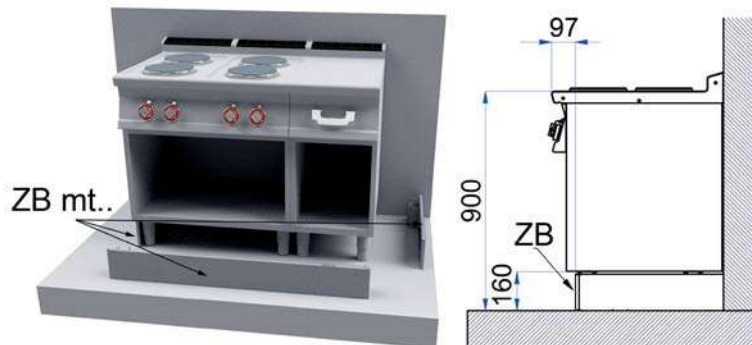
€ 159,00

COR1/9-20

08570202



CORRIMANO FRONTALE CON INVASO, INCLUSO NR.1 TELAIO CM.20 CON BACINELLA GN1/9X10H A SCORRIMENTO

- EN** Front handrail, including one 20cm sliding frame with GN1/9x10h tray
- DE** Vorderer Handlauf, einschließlich eines 20 cm breiten Schieberahmens mit GN1/9x10h-Ablage
- FR** Main courante avant, comprenant un cadre coulissant de 20 cm avec plateau GN1/9x10h
- ES** **PASAMANOS FRONTAL, INCLUYE 1 MARCO DESLIZANTE DE 20 CM CON BANDEJA GN1/9X10H**

cm. 20 x 14X 5h

 cm. 24 x 20 x 15h / kg 1 / m³ 0,007

€ 363,00
COR1/9-30

08570203

cm. 30 x 14X 5h

 cm. 34 x 20 x 15h / kg 1.1 / m³ 0,010

€ 367,00

COR1/9-40 08570204	<p>CORRIMANO FRONTALE CON INVASO, INCLUSO NR.1 TELAIO CM.20 CON BACINELLA GN1/9X10H E NR.1 GRIGLIA CM.20 A SCORRIMENTO</p> <p>EN Front handrail, including one 20cm frame with GN1/9x10h tray and one 20cm sliding grid</p> <p>DE Vorderer Handlauf, einschließlich eines 20 cm Rahmens mit GN1/9x10h Ablage und eines 20 cm Schiebegitters</p> <p>FR Main courante avant, comprenant un cadre de 20 cm avec plateau GN1/9x10h et une grille coulissante de 20 cm</p> <p>ES PASAMANOS FRONTAL, INCLUYE 1 MARCO DE 20 CM CON BANDEJA GN1/9X10H Y 1 REJILLA DESLIZANTE DE 20 CM</p> <p>↳ cm. 40 x 14X 5h</p> <p>📦 cm. 44 x 20 x 15h / kg 1.6 / m³ 0,013</p>	€ 393,00
COR1/9-50 08570205	<p>↳ cm. 50 x 14X 5h</p> <p>📦 cm. 54 x 20 x 15h / kg 2 / m³ 0,016</p>	€ 415,00
COR1/9-60 08570206	<p>↳ cm. 60 x 14X 5h</p> <p>📦 cm. 64 x 20 x 15h / kg 2.4 / m³ 0,019</p>	€ 433,00
COR1/9-70 08570207	<p>↳ cm. 70 x 14X 5h</p> <p>📦 cm. 74 x 20 x 15h / kg 2.8 / m³ 0,022</p>	€ 456,00
COR1/9-80 08570208	<p>↳ cm. 80 x 14X 5h</p> <p>📦 cm. 84 x 20 x 15h / kg 3.2 / m³ 0,025</p>	€ 477,00
COR1/9-90 08570209	<p>↳ cm. 90 x 14X 5h</p> <p>📦 cm. 94 x 20 x 15h / kg 3.6 / m³ 0,028</p>	€ 492,00
COR1/9-100 08570210	<p>↳ cm. 100 x 14X 5h</p> <p>📦 cm. 104 x 20 x 15h / kg 4 / m³ 0,031</p>	€ 517,00
COR1/9-110 08570211	<p>↳ cm. 110 x 14X 5h</p> <p>📦 cm. 114 x 20 x 15h / kg 7.7 / m³ 0,034</p>	€ 536,00
COR1/9-120 08570212	<p>↳ cm. 120 x 14X 5h</p> <p>📦 cm. 124 x 20 x 15h / kg 8.4 / m³ 0,037</p>	€ 558,00
KIT-COR1/9 0857020A	<p>KIT NR.1 TELAIO CM.20 CON BACINELLA GN1/9X10H E NR.1 GRIGLIA CM.20 A SCORRIMENTO</p> <p>EN Kit one 20cm frame with GN1/9x10h tray and one 20cm sliding grid</p> <p>DE kit eines 20 cm Rahmens mit GN1/9x10h Ablage und eines 20 cm Schiebegitters</p> <p>FR Kit un cadre de 20 cm avec plateau GN1/9x10h et une grille coulissante de 20 cm</p> <p>ES KIT 1 MARCO DE 20 CM CON BANDEJA GN1/9X10H Y 1 REJILLA DESLIZANTE DE 20 CM</p> <p>↳ cm.20/20 x 12X 10h</p> <p>📦 cm. 21 x 15 x 15h / kg 0.2 / m³ 0,005</p>	€ 91,00

TPA-7

08560001



TESTATA CHIUSURA PIANO (IN DOTAZIONE 1 PEZZO PER APPARECCHIO)

€ 79,00
EN Head end filler strip (1 piece included in each machine)

DE Abschluss-Element (1 Stück in jeder Maschine enthalten)

FR Élément de jonction top (1 pièce incluse dans chaque machine)

ES CHAPA DE CIERRE PARA TOP (1 PIEZA INCLUIDA EN CADA EQUIPO)

cm. 0,2 x 70,5

 cm. 2 x 72 x 15h / kg 1 / m³ 0,002

TMA-7SX

08540701



TESTATA 1 LATO SERIE 70 SINISTRA

€ 288,00
EN Head 1 side S70 left

DE Abschluss element 1 seite S70 links

FR Element de jonction 1 coté S70 gauche

ES EMBELLECEDOR 1 LADO S70 IZQUIERDA

cm. 0,2 x 70,5

 cm. 100 x 3 x 100h / kg 8 / m³ 0,030

TMA-7DX

08540700



TESTATA 1 LATO SERIE 70 DESTRA

€ 288,00
EN Head 1 side S70 right

DE Abschluss element 1 seite S70 recht

FR Element de jonction 1 coté S70 droit

ES EMBELLECEDOR 1 LADO S70 DERECHA

cm. 0,2 x 70,5

 cm. 100 x 3 x 100h / kg 8 / m³ 0,030

TMA-77

08547700



TESTATA 2 LATI SERIE 70

€ 579,00
EN Head 2 sides S70

DE Abschluss element seiten S70

FR Element de jonction 2 cotés S70

ES EMBELLECEDOR 2 LADOS S70

cm. 0,2 x 141

 cm. 200 x 3 x 100h / kg 16 / m³ 0,060

TMA-79SX

08547901

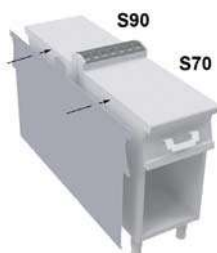

TESTATA 2 LATI SERIE 70/90 SINISTRA

€ 592,00
EN Head 2 sides S70/90 left

DE Abschluss element seiten S70/90 links

FR Element de jonction 2 cotés S70/90 gauche

ES EMBELLECEDOR 2 LADOS S70/90 IZQUIERDA

cm. 0,2 x 160,5

 cm. 200 x 3 x 100h / kg 18 / m³ 0,060

TMA-79DX

08547900



TESTATA 2 LATI SERIE 70/90 DESTRA

- EN** Head 2 sides S70/90 right
- DE** Abschluss element seiten S70/90 recht
- FR** Element de jonction 2 cotés S70/90 droit
- ES** **EMBELLECEDOR 2 LADOS S70/90 DERECHA**

cm. 0,2 x 160,5

 cm. 200 x 3 x 100h / kg 18 / m³ 0,060

€ 592,00

TMTA-7SX

08540721



TESTATA TAMBURATA 1 LATO SERIE 70 SINISTRA, CON STESSO PROFILO LINEA FRONTALE

- EN** Head 1 side S70 left, with the same front line profile
- DE** Abschluss element 1 seite S70 links, mit dem gleichen Frontlinienprofil
- FR** Element de jonction 1 coté S70 gauche, avec le même profil de ligne
- ES** **EMBELLECEDOR 1 LADO S70 IZQUIERDA, CON EL MISMO PERFIL DE LÍNEA FRONTAL**

cm. 7,5 x 70,5

 cm. 78 x 87 x 23h / kg 14 / m³ 0,156

€ 907,00

TMTA-7DX

08540720



TESTATA TAMBURATA 1 LATO SERIE 70 DESTRA, CON STESSO PROFILO LINEA FRONTALE

- EN** Head 1 side S70 right, with the same front line profile
- DE** Abschluss element 1 seite S70 recht, mit dem gleichen Frontlinienprofil
- FR** Element de jonction 1 coté S70 droit, avec le même profil de ligne
- ES** **EMBELLECEDOR 1 LADO S70 DERECHA, CON EL MISMO PERFIL DE LÍNEA FRONTAL**

cm. 7,5 x 70,5

 cm. 78 x 87 x 23h / kg 14 / m³ 0,156

€ 907,00

TMTA-77

08547720



TESTATA TAMBURATA 2 LATI SERIE 70, CON STESSO PROFILO LINEA FRONTALE

- EN** Head 2 sides S70, with the same front line profile
- DE** Abschluss element seiten S70, mit dem gleichen Frontlinienprofil
- FR** Element de jonction 2 cotés S70, avec le même profil de ligne
- ES** **EMBELLECEDOR 2 LADOS S70, CON EL MISMO PERFIL DE LÍNEA FRONTAL**

cm. 7,5 x 141

 cm. 148 x 87 x 23h / kg 28 / m³ 0,296

€ 1.756,00

TMTA-79

08547920

TESTATA TAMBURATA 2 LATI SERIE 70/90, CON STESSO PROFILO LINEA FRONTALE

- EN** Head 2 sides S70/90, with the same front line profile
- DE** Abschluss element seiten S70/90, mit dem gleichen Frontlinienprofil
- FR** Element de jonction 2 cotés S70/90, avec le même profil de ligne
- ES** **EMBELLECEDOR 2 LADOS S70/90, CON EL MISMO PERFIL DE LÍNEA FRONTAL**

cm. 7,5 x 160,5

 cm. 168 x 87 x 23h / kg 30 / m³ 0,336

€ 1.784,00

SA-72/92

08600200



SCHIENA POSTERIORE A VISTA PER APPARECCHI

EN Back cover

DE Ruckenwand

FR Dos de finition

ES PANEL POSTERIOR

cm. 20 x 1,5 x 97h

 cm. 22 x 3 x 98h / kg 2 / m³ 0,006

€ 116,00
SA-73/93

08600300

cm. 30 x 1,5 x 97h

 cm. 32 x 3 x 98h / kg 3 / m³ 0,009

€ 132,00
SA-74/94

08600400

cm. 40 x 1,5 x 97h

 cm. 42 x 3 x 98h / kg 3 / m³ 0,012

€ 150,00
SA-75/95

08600500

cm. 50 x 1,5 x 97h

 cm. 52 x 3 x 98h / kg 4 / m³ 0,015

€ 189,00
SA-76/96

08600600

cm. 60 x 1,5 x 97h

 cm. 62 x 3 x 98h / kg 4 / m³ 0,018

€ 218,00
SA-77/97

08600700

cm. 70 x 1,5 x 97h

 cm. 72 x 3 x 98h / kg 5 / m³ 0,021

€ 231,00
SA-78/98

08600800

cm. 80 x 1,5 x 97h

 cm. 82 x 3 x 98h / kg 5 / m³ 0,024

€ 255,00
SA-79/99

08600900

cm. 90 x 1,5 x 97h

 cm. 92 x 3 x 98h / kg 6 / m³ 0,027

€ 286,00
SA-710/910

08601000

cm. 100 x 1,5 x 97h

 cm. 102 x 3 x 98h / kg 6 / m³ 0,030

€ 318,00
SA-711/911

08601100

cm. 110 x 1,5 x 97h

 cm. 112 x 3 x 98h / kg 7 / m³ 0,033

€ 351,00
SA-712/912

08601200

cm. 120 x 1,5 x 97h

 cm. 122 x 3 x 98h / kg 7 / m³ 0,036

€ 382,00
SA-713/913

08601300

cm. 130 x 1,5 x 97h

 cm. 132 x 3 x 98h / kg 8 / m³ 0,039

€ 415,00
SA-714/914

08601400

cm. 140 x 1,5 x 97h

 cm. 142 x 3 x 98h / kg 8 / m³ 0,042

€ 445,00
SA-715/915

08601500

cm. 150 x 1,5 x 97h

 cm. 152 x 3 x 98h / kg 10 / m³ 0,045

€ 476,00
SA-716/916

08601600

cm. 160 x 1,5 x 97h

 cm. 162 x 3 x 98h / kg 10 / m³ 0,048

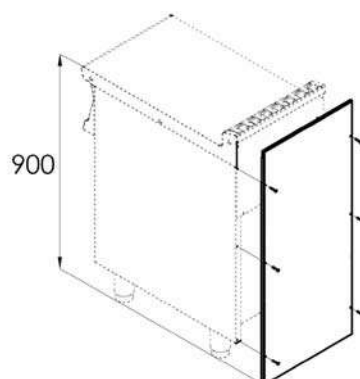
€ 508,00

KIT-TOPM-SA

08600001

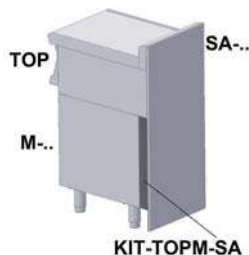

KIT TAMPONAMENTI LATERALI PER SCHIENA POSTERIORE MONTATA SU APPARECCHI TOP E MOBILI "M-.."

EN Side KIT for back cover mounted on the TOP machine and Stand "M-.."**DE** Seitliches KIT für Rückenwand montiert auf der TOP-Maschine und Unterbau "M-.."**FR** KIT latéral pour Dos de finition monté sur la machine TOP et Placard "M-.."**ES** KIT LATERAL PARA PANEL POSTERIORE MONTADO EN LA MÁQUINA TOP Y MUEBLE BASE "M-.."
 cm. 50 x 10 x 10h / kg 1 / m³ 0,005

€ 103,00

TSP-4

18400400



COPPIA TRAVERSE SUPPORTO PONTE

EN Support for bridge type system**DE** Bruckengestell**FR** Support en pont**ES** SOPORTE EN PUENTE PARA EQUIPO

cm. 40 x 6 x 6

 cm. 44 x 10 x 15h / kg 5 / m³ 0,007

€ 240,00

TSP-6

18400600

cm. 60 x 6 x 6

 cm. 64 x 10 x 15h / kg 7 / m³ 0,010

€ 270,00

TSP-8

18400800

cm. 80 x 6 x 6

 cm. 84 x 10 x 15h / kg 9 / m³ 0,013

€ 302,00

TSP-10

18401000

cm. 100 x 6 x 6

 cm. 104 x 10 x 15h / kg 11 / m³ 0,016

€ 336,00

TSP-12

18401200

cm. 120 x 6 x 6

 cm. 124 x 10 x 15h / kg 13 / m³ 0,019

€ 365,00

TSP-14

18401400

cm. 140 x 6 x 6

 cm. 144 x 10 x 15h / kg 15 / m³ 0,022

€ 396,00

TSP-16

18401600

cm. 160 x 6 x 6

 cm. 164 x 10 x 15h / kg 17 / m³ 0,025

€ 421,00

TSP-18

18401800

cm. 180 x 6 x 6

 cm. 184 x 10 x 15h / kg 19 / m³ 0,028

€ 462,00

TSP-20

18402000

cm. 200 x 6 x 6

 cm. 204 x 10 x 15h / kg 21 / m³ 0,031

€ 485,00

18590012

RACCORDO INGRESSO GAS COMPATTO A 90° 1/2", INCLUSA GUARNIZIONE

EN COMPACT GAS INLET FITTING AT 90° 1/2" INCLUDING GASKET**DE** KOMPAKTE 90° 1/2" GASEINLASSARMATUR, INKLUSIVE DICHTUNG**FR** RACCORD D'ENTRÉE DE GAZ COMPACT À 90° 1/2", AVEC JOINT**ES** CONEXIÓN DE GAS COMPACTA A 90° 1/2", CON JUNTA
 cm. 10 x 10 x 10h / kg 0.1 / m³ 0,001

€ 21,00

**18590034**

RACCORDO INGRESSO GAS COMPATTO A 90° 3/4", INCLUSA GUARNIZIONE

EN COMPACT GAS INLET FITTING AT 90° 3/4" INCLUDING GASKET**DE** KOMPAKTE 90° 3/4" GASEINLASSARMATUR, INKLUSIVE DICHTUNG**FR** RACCORD D'ENTRÉE DE GAZ COMPACT À 90° 3/4", AVEC JOINT**ES** CONEXIÓN DE GAS COMPACTA A 90° 3/4", CON JUNTA
 cm. 10 x 10 x 10h / kg 0.1 / m³ 0,001

€ 27,00

ACCESSORI CUOCIPASTA TOP

EN PASTA COOKERS ACCESSORIES - TOP **DE** ZUBEHÖR NUDELKOCHER - TOP **FR** ACCESSOIRES CUISEURS DE PÂTES - TOP **ES** **ACCESSORIOS CUECEPASTAS - TOP**

531018800

CESTO 1/2 PER CPT-74 - 1/3 PER CPT-76

EN Basket 1/2 for CPT-74 - 1/3 for CPT-76

DE Korb 1/2 für CPT-74 - 1/3 für CPT-76

FR Panier 1/2 pour CPT-74 - 1/3 pour CPT-76

ES **CESTA 1/2 PARA CPT-74 - 1/3 PARA CPT-76**

cm. 14,5 x 29 x 15h

 cm. 25 x 54 x 30h / kg 1,3 / m³ 0,041

€ 143,00
531053800

CESTO 1/4 PER CPT-76

EN Basket 1/4 for CPT-76

DE Korb 1/4 für CPT-76

FR Panier 1/4 pour CPT-76

ES **CESTA 1/4 PARA CPT-76**

cm. 11,5 x 29 x 15h

 cm. 22 x 54 x 30h / kg 1,2 / m³ 0,036

€ 136,00
531040000

CESTO 1/1 PER CPT-76

EN Basket 1/1 for CPT-76

DE Korb 1/1 für CPT-76

FR Panier 1/1 pour CPT-76

ES **CESTA 1/1 PARA CPT-76**

cm. 49 x 29 x 15h

 cm. 59 x 39 x 30h / kg 3,5 / m³ 0,069

€ 245,00
531048900

CESTO 1/6 PER CPT-74

EN Basket 1/6 for CPT-74

DE Korb 1/6 für CPT-74

FR Panier 1/6 pour CPT-74

ES **CESTA 1/6 PARA CPT-74**

cm. 14 x 10 x 15h

 cm. 24 x 20 x 30h / kg 1 / m³ 0,014

€ 89,00
531053700

CESTO 1/4 PER CPT-74 - 1/6 PER CPT-76

EN Basket 1/4 for CPT-74 - 1/6 for CPT-76

DE Korb 1/4 für CPT-74 - 1/6 für CPT-76

FR Panier 1/4 pour CPT-74 - 1/6 pour CPT-76

ES **CESTA 1/4 PARA CPT-74 - 1/6 PARA CPT-76**

cm. 14 x 16 x 15h

 cm. 24 x 26 x 30h / kg 1 / m³ 0,019

€ 96,00

531053500

CESTO 1/1 PER CPT-74

- EN** Basket 1/1 for CPT-74
- DE** Korb 1/1 für CPT-74
- FR** Panier 1/1 pour CPT-74
- ES** **CESTA 1/1 PARA CPT-74**

cm. 29 x 29 x 15h

 cm. 39 x 39 x 30h / kg 1,5 / m³ 0,046
€ 176,00**531071300**

CESTO CON GANCIO 1/2 PER CPT-74 - 1/3 PER CPT-76

- EN** Basket with hook 1/2 for CPT-74 - 1/3 for CPT-76
- DE** Korb mit Haken 1/2 für CPT-74 - 1/3 für CPT-76
- FR** Panier avec crochet 1/2 pour CPT-74 - 1/3 pour CPT-76
- ES** **CESTA CON GANCHO 1/2 PARA CPT-74 - 1/3 PARA CPT-76**

cm. 13,5 x 25,5 x 15h

 cm. 24 x 51 x 30h / kg 1,3 / m³ 0,037
€ 141,00**531071400**

CESTO CON GANCIO 1/4 PER CPT-76

- EN** Basket with hook 1/4 for CPT-76
- DE** Korb mit Haken 1/4 für CPT-76
- FR** Panier avec crochet 1/4 pour CPT-76
- ES** **CESTA CON GANCHO 1/4 PARA CPT-76**

cm. 11 x 25,5 x 15h

 cm. 21 x 51 x 30h / kg 1,2 / m³ 0,032
€ 134,00**531071800**

GRIGLIA SUPPORTO CESTI CON GANCIO PER CPT-74

- EN** support for baskets with hook for CPT-74
- DE** Unterstützung für Körbe mit Haken für CPT-74
- FR** soutien pour les paniers avec crochet pour CPT-74
- ES** **SOPORTE PARA CESTAS CON GANCHO PARA CPT-74**

cm. 30 x 33 x 25h

 cm. 35 x 38 x 30h / kg 3 / m³ 0,040
€ 143,00**531071900**

GRIGLIA SUPPORTO CESTI CON GANCIO PER CPT-76

- EN** support for baskets with hook for CPT-76
- DE** Unterstützung für Körbe mit Haken für CPT-76
- FR** soutien pour les paniers avec crochet pour CPT-76
- ES** **SOPORTE PARA CESTAS CON GANCHO PARA CPT-76**

cm. 50 x 30 x 25h

 cm. 55 x 35 x 30h / kg 3,5 / m³ 0,058
€ 185,00

ACCESSORI FRY-TOP TOP
EN GRIDDLE ACCESSORIES - TOP DE ZUBEHÖR GRIDDLEPLATTEN - TOP FR ACCESSOIRES FRY-TOP - TOP ES ACCESORIOS FRY-TOP - TOP
544023800

RASCHIETTO PER PIASTRA RIGATA

EN Scraper for grooved plate
DE Schaber für gerillte Kochplatte
FR Racloir pour plaque nervurée
ES **RASQUETA PARA PLACA RANURADA**

€ 71,00

 cm. 20 x 7 x 3h / kg 0.5 / m³ 0,001

531040800

RASCHIETTO PER PIASTRA LISCIA AL CROMO LUCIDO

EN Scraper for smooth POLISHED CHROME plate
DE Schaber für glatte POLIERTEM CHROM Platte
FR Racloir pour plaque lisse au CHROME POLI
ES **RASQUETA PARA PLACA LISA DE CROMO PULIDO**

€ 65,00

 cm. 20 x 7 x 3h / kg 0.5 / m³ 0,001

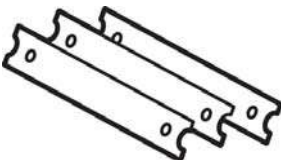
531040900

KIT 10 LAME PER RASCHIETTO COD.531040800

EN 10 blades kit for scraper cod.531040800
DE Kit 10 klingen für Schaber cod.531040800
FR Kit de 10 lames pour racloir cod.531040800
ES **KIT DE 10 CUCHILLAS PARA RASQUETA COD.531040800**

€ 46,00

 cm. 10 x 10 x 5h / kg 0.5 / m³ 0,001

T-FT

09580060

TAPPO PER FRY-TOP

EN stopper for Fry-top
DE Stopfen griddleplatte
FR bouchon pour Plaque
ES **TAPÓN FRY-TOP**

€ 275,00

cm. 10 x 2 x 5h
 cm. 20 x 20 x 10h / kg 0.5 / m³ 0,004

PFT-74

08620400

KIT PROTEZIONE FRONTALE PIANO FRY-TOP

EN KIT front protection plan fry-top
DE Schutz-kit vorne Plan griddleplatte
FR KIT protection avant plan plaque
ES **KIT DE PROTECCIÓN FRONTAL PLAN DE FRY-TOP**

€ 141,00

cm. 35 x 8 x 6h
 cm. 41 x 11 x 9h / kg 2 / m³ 0,004

PFT-76

08620600

cm. 55 x 8 x 6h
 cm. 61 x 11 x 9h / kg 3 / m³ 0,006

€ 191,00
PFT-78

08620800

cm. 75 x 8 x 6h
 cm. 81 x 11 x 9h / kg 4 / m³ 0,008

€ 240,00
PFT-712

08621200

cm. 115 x 8 x 6h
 cm. 121 x 11 x 9h / kg 6 / m³ 0,012

€ 272,00

ACCESSORI GRIGLIE TOP

EN GRILL ACCESSORIES - TOP DE ZUBEHÖR GRILLS - TOP FR ACCESSOIRES CHARCOAL - TOP ES ACCESORIOS BARBACOAS - TOP

08570401



GRIGLIA TONDINO PER CW (SERIE 70)

EN Grid for CW (70 line)
 DE Gitter für CW (70. Serie)
 FR Grille ronde pour CW (serie 70)
 ES REJILLA PARA CW (SERIE 70)

↙ cm. 36 x 51 x
 📦 cm. 40 x 65 x 10h / kg 11 / m³ 0,026

€ 469,00

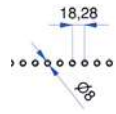

08570402



GRIGLIA TEGOLO V PER CW (SERIE 70)

EN Grid V for CW (70 line)
 DE Gitter V für CW (70. Serie)
 FR Grille V pour CW (serie 70)
 ES REJILLA V PARA CW (SERIE 70)

↙ cm. 36 x 51 x
 📦 cm. 40 x 65 x 10h / kg 11 / m³ 0,026

€ 469,00

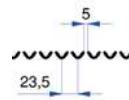

ACCESSORI FRIGGITRICI TOP

EN FRYERS ACCESSORIES - TOP DE ZUBEHÖR FRITEUSE - TOP FR ACCESSOIRES FRITEUSE - TOP ES ACCESORIOS FREIDORAS - TOP

531048800



CESTO 1/2 PER F13T-G/E

EN Basket 1/2 for F13T-G/E
 DE Korb 1/2 zur Friteuse F13T-G/E
 FR Panier 1/2 pour F13T-G/E
 ES CESTA 1/2 PARA F13T-G/E

↙ cm. 13,5 x 29 x 9h
 📦 cm. 24 x 54 x 24h / kg 0.8 / m³ 0,031

€ 102,00

ACCESSORI BASE CON FORNO

EN STAND WITH OVEN ACCESSORIES DE ZUBEHÖR UNTERBAU MIT OFEN FR ACCESSOIRES PALCARD AVEC FOUR ES ACCESORIOS MUEBLE CON HORNO

CMF-78

08490800



COPERCHIO PER MFV-78E

EN Lid for MFV-78E
 DE Berichterstattung für MFV-78E
 FR Couvercle pour MFV-78E
 ES CUBERTURA PARA MFV-78E

↙ cm. 80 x 62,5 x 2,8h
 📦 cm. 83 x 65 x 5h / kg 5 / m³ 0,027

€ 270,00

CMF-710

08491000

COPERCHIO PER MF-710E

EN Lid for MF-710E
 DE Berichterstattung für MF-710E
 FR Couvercle pour MF-710E
 ES CUBERTURA PARA MF-710E

↙ cm. 100 x 62,5 x 2,8h
 📦 cm. 103 x 65 x 5h / kg 6 / m³ 0,033

€ 327,00